

# Easy Altivar ATV610

## Variable Speed Drives

## Programming Manual

12/2019



---

The information provided in this documentation contains general descriptions and/or technical characteristics of the performance of the products contained herein. This documentation is not intended as a substitute for and is not to be used for determining suitability or reliability of these products for specific user applications. It is the duty of any such user or integrator to perform the appropriate and complete risk analysis, evaluation and testing of the products with respect to the relevant specific application or use thereof. Neither Schneider Electric nor any of its affiliates or subsidiaries shall be responsible or liable for misuse of the information contained herein. If you have any suggestions for improvements or amendments or have found errors in this publication, please notify us.

You agree not to reproduce, other than for your own personal, noncommercial use, all or part of this document on any medium whatsoever without permission of Schneider Electric, given in writing. You also agree not to establish any hypertext links to this document or its content. Schneider Electric does not grant any right or license for the personal and noncommercial use of the document or its content, except for a non-exclusive license to consult it on an "as is" basis, at your own risk. All other rights are reserved.

All pertinent state, regional, and local safety regulations must be observed when installing and using this product. For reasons of safety and to help ensure compliance with documented system data, only the manufacturer should perform repairs to components.

When devices are used for applications with technical safety requirements, the relevant instructions must be followed.

Failure to use Schneider Electric software or approved software with our hardware products may result in injury, harm, or improper operating results.

Failure to observe this information can result in injury or equipment damage.

© 2019 Schneider Electric. All rights reserved.

# Table of Contents



	Safety Information . . . . .	9
	About the Book . . . . .	15
Part I	Introduction . . . . .	17
Chapter 1	Setup . . . . .	19
	Initial Steps . . . . .	20
	Steps for Setting-Up the Drive . . . . .	22
	Software Enhancements . . . . .	23
Chapter 2	Overview . . . . .	25
	Factory Configuration . . . . .	26
	Macro Configuration . . . . .	27
	Basic Functions . . . . .	29
	Plain Text Display Terminal . . . . .	30
	Structure of the Parameter Table . . . . .	32
	Finding a Parameter in This Document . . . . .	33
Part II	Programming . . . . .	35
Chapter 3	[Simply start] 5 4 5 - . . . . .	37
	[Macro-configuration] C F G - Menu . . . . .	38
	[Simply start] 5 , П - Menu . . . . .	39
	[Modified parameters] L П d - Menu . . . . .	42
Chapter 4	[Display] П o n - . . . . .	43
4.1	[Motor parameters] . . . . .	44
	[Motor parameters] П П o - Menu . . . . .	44
4.2	[Drive parameters] . . . . .	46
	[Drive parameters] П П , - Menu . . . . .	46
4.3	[I/O map] . . . . .	49
	[Digital input map] L , A - Menu . . . . .	50
	[AI1] A , 1 C - Menu . . . . .	51
	[AI2] A , 2 C - Menu . . . . .	53
	[AI3] A , 3 C - Menu . . . . .	54
	[AI4] A , 4 C - Menu . . . . .	55
	[AI5] A , 5 C - Menu . . . . .	56
	[AQ1] A o 1 C - Menu . . . . .	57
	[AQ2] A o 2 C - Menu . . . . .	61
	[Digital output map] L o A - Menu . . . . .	62
4.4	Energy parameters . . . . .	63
	[Energy parameters] E n P - Menu . . . . .	63
4.5	[Communication map] . . . . .	64
	[Communication map] C П П - Menu . . . . .	65
	[Modbus network diag] П n d - Menu . . . . .	68
	[Com. scanner input map] , 5 A - Menu . . . . .	69
	[Com scan output map] o 5 A - Menu . . . . .	70
	[Modbus HMI Diag] П d H - Menu . . . . .	71
	[Command word image] C W , - Menu . . . . .	72
	[Freq. ref. word map] r W , - Menu . . . . .	72
4.6	[Application parameters] . . . . .	73
	[Variable Speed Pump] П P P - Menu . . . . .	74
	[Booster Control Pump] b C P - Menu . . . . .	78

<b>Chapter 5</b>	<b>[Diagnostics] <i>d , R</i> -</b> .....	<b>79</b>
5.1	[Diag. data] .....	80
	[Diag. data] <i>d d t</i> - Menu .....	81
	[Other State] <i>S S t</i> - Menu .....	82
	[Identification] <i>o , d</i> - Menu .....	82
5.2	[Error history] <i>P F H</i> - Menu .....	83
	[Error history] <i>P F H</i> - Menu .....	83
5.3	[Warnings] <i>R L r</i> - Menu .....	86
	[Actual warnings] <i>R L r d</i> - Menu .....	87
	[Warnings] <i>R L r</i> - Menu .....	87
<b>Chapter 6</b>	<b>[Complete settings] <i>C S t</i> -</b> .....	<b>89</b>
6.1	[Motor parameters] <i>Π P R</i> - Menu .....	90
	[Motor parameters] <i>Π P R</i> - Menu .....	90
6.2	[Input/Output] <i>, o</i> - Menu .....	101
	[Input/Output] <i>, o</i> - Menu .....	102
	[DI1 Assignment] <i>L , 1 C</i> - Menu .....	104
	[DI2 Assignment] <i>L , 2 C</i> - Menu .....	105
	[DI3 Assignment] <i>L , 3 C</i> - Menu .....	105
	[DI4 Assignment] <i>L , 4 C</i> - Menu .....	106
	[DI5 Assignment] <i>L , 5 C</i> - Menu .....	106
	[DI6 Assignment] <i>L , 6 C</i> - Menu .....	107
	[DI11 Assignment] <i>d , 1 1</i> - Menu .....	107
	[DI12 Assignment] <i>d , 1 2</i> - Menu .....	108
	[DI13 Assignment] <i>d , 1 3</i> - Menu .....	108
	[DI14 Assignment] <i>d , 1 4</i> - Menu .....	109
	[DI15 Assignment] <i>d , 1 5</i> - Menu .....	109
	[DI16 Assignment] <i>d , 1 6</i> - Menu .....	110
	[Input/Output] <i>, o</i> - Menu .....	111
	[AI1 configuration] <i>R , 1</i> - Menu .....	113
	[AI2 configuration] <i>R , 2</i> - Menu .....	115
	[AI3 configuration] <i>R , 3</i> - Menu .....	117
	[AI4 configuration] <i>R , 4</i> - Menu .....	118
	[AI5 configuration] <i>R , 5</i> - Menu .....	119
	[Virtual AI1] <i>R V 1</i> - Menu .....	120
	[DQ11 Configuration] <i>d o 1 1</i> - Menu .....	121
	[DQ12 Configuration] <i>d o 1 2</i> - Menu .....	123
	[R1 configuration] <i>r 1</i> - Menu .....	124
	[R2 configuration] <i>r 2</i> - Menu .....	126
	[R3 configuration] <i>r 3</i> - Menu .....	127
	[R4 configuration] <i>r 4</i> - Menu .....	127
	[R5 configuration] <i>r 5</i> - Menu .....	128
	[R6 configuration] <i>r 6</i> - Menu .....	128
	[AQ1 configuration] <i>R o 1</i> - Menu .....	129
	[AQ2 configuration] <i>R o 2</i> - Menu .....	133
6.3	[Command and Reference] <i>C r P</i> - Menu .....	134
	[Command and Reference] <i>C r P</i> - Menu .....	134
6.4	[Generic functions] - [Ramp] .....	145
	[Ramp] <i>r R Π P</i> - Menu .....	145
6.5	[Generic functions] - [+/- speed] .....	149
	[+/- speed] <i>υ P d</i> - Menu .....	149
6.6	[Generic functions] - [Stop configuration] .....	152
	[Stop configuration] <i>S t t</i> - Menu .....	152
6.7	[Generic functions] - [Auto DC injection] .....	157
	[Auto DC injection] <i>R d C</i> - Menu .....	157

6.8	[Generic functions] - [Jog] .....	160
	[Jog] <i>JOG</i> - Menu .....	160
6.9	[Generic functions] - [Preset speeds] .....	162
	[Preset speeds] <i>PSS</i> - Menu .....	162
6.10	[Generic functions] - [Jump frequency] .....	166
	[Jump frequency] <i>JUF</i> - Menu .....	166
6.11	[Generic functions] - [Define system units] <i>SUC</i> - Menu .....	168
	[Define system units] <i>SUC</i> - Menu .....	168
6.12	[Generic functions] - [PID controller] .....	172
	[PID controller] <i>PID</i> - Overview .....	173
	[PID Feedback] <i>fdb</i> - Menu .....	177
	[PID Reference] <i>rF</i> - Menu .....	183
	[PID preset references] <i>Pr</i> - Menu .....	186
	[PID Reference] <i>rF</i> - Menu .....	188
	[Settings] <i>SE</i> - Menu .....	189
6.13	[Generic functions] - [Sleep/wakeup] <i>SPW</i> - Menu .....	192
	[Sleep/Wakeup] <i>SPW</i> - Overview .....	193
	[Sleep menu] <i>SLP</i> - Menu .....	197
	[AI1 Sensor config.] <i>SF1</i> - Menu .....	199
	[AI2 Sensor config.] <i>SF2</i> - Menu .....	201
	[AI3 Sensor config.] <i>SF3</i> - Menu .....	203
	[AI4 Sensor config.] <i>SF4</i> - Menu .....	204
	[AI5 Sensor config.] <i>SF5</i> - Menu .....	205
	[DI5 Sensor Configuration] <i>SFB</i> - Menu .....	206
	[DI6 Sensor Configuration] <i>SF9</i> - Menu .....	207
	[AIV1 Sensor config.] <i>SV1</i> - Menu .....	208
	[Sleep menu] <i>SLP</i> - Menu .....	209
	[Boost] <i>SbE</i> - Menu .....	211
	[Advanced sleep check] <i>RdS</i> - Menu .....	212
	[Wake up menu] <i>WKP</i> - Menu .....	215
6.14	[Generic functions] - [Threshold reached] .....	217
	[Threshold reached] <i>THE</i> - Menu .....	217
6.15	[Generic functions] - [Mains contactor command] .....	219
	[Mains contactor command] <i>LCC</i> - Menu .....	219
6.16	[Generic functions] - [Parameters switching] .....	221
	[Parameters switching] <i>PLP</i> - Menu .....	222
	[Set 1] <i>PS1</i> - Menu .....	224
	[Set 2] <i>PS2</i> - Menu .....	224
	[Set 3] <i>PS3</i> - Menu .....	224
6.17	[Generic functions] - [Stop after speed timeout] .....	225
	[Stop after speed timeout] <i>PrSP</i> - Menu .....	225
6.18	[Generic functions] - [Advanced sleep check] <i>RdS</i> - Menu .....	227
	[Advanced sleep check] <i>RdS</i> - Menu .....	227
6.19	[Generic functions] - [Booster control] .....	230
	[System Architecture] <i>PP9</i> - Menu .....	231
	[Pumps configuration] <i>PuPP</i> - Menu .....	235
	[System Architecture] <i>PP9</i> - Menu .....	238
	[Booster control] <i>bSC</i> - Menu .....	239
	[Stage/Destage condition] <i>SDCn</i> - Menu .....	240
	[Booster control] <i>bSC</i> - Menu .....	241
6.20	[Generic monitoring] .....	242
	[Stall monitoring] <i>SEPr</i> - Menu .....	243
	[Therm sensor monit] <i>TESP</i> - Menu .....	244

6.21	[Error/Warning handling] .....	251
	[Fault reset] <i>r 5 t</i> - Menu .....	252
	[Auto fault reset] <i>R E r</i> - Menu .....	254
	[Catch on the fly] <i>F L r</i> - Menu .....	255
	[Motor thermal monit] <i>t H t</i> - Menu .....	256
	[Output phase loss] <i>o P L</i> - Menu .....	258
	[Input phase loss] <i>i P L</i> - Menu .....	258
	[External error] <i>E t F</i> - Menu .....	259
	[Undervoltage handling] <i>u 5 b</i> - Menu .....	260
	[Ground Fault] <i>G r F L</i> - Menu .....	262
	[4-20mA loss] <i>L F L</i> - Menu .....	263
	[Fallback Speed] <i>L F F</i> - Menu .....	264
	[Error detection disable] <i>i n H</i> - Menu .....	265
	[Fieldbus monitoring] <i>C L L</i> - Menu .....	266
	[Communication module] <i>C o M o</i> - Menu .....	267
	[Error/Warning handling] <i>C 5 W n</i> - Menu .....	268
	[Process underload] <i>u L d</i> - Menu .....	269
	[Process overload] <i>o L d</i> - Menu .....	271
	[Warn grp 1 definition] <i>R 1 C</i> - Menu .....	273
	[Warn grp 2 definition] <i>R 2 C</i> - Menu .....	273
	[Warn grp 3 definition] <i>R 3 C</i> - Menu .....	273
	[Warn grp 4 definition] <i>R 4 C</i> - Menu .....	273
	[Warn grp 5 definition] <i>R 5 C</i> - Menu .....	273
6.22	[Maintenance] .....	274
	[Diagnostics] <i>d A u</i> - Menu .....	275
	[Fan management] <i>F A n A</i> - Menu .....	276
	[Maintenance] <i>C 5 n A</i> - Menu .....	277
Chapter 7	[Communication] <i>C o M</i> - .....	279
	[Modbus Fieldbus] <i>M d I</i> - Menu .....	280
	[Com. scanner input] <i>i C 5</i> - Menu .....	281
	[Com. scanner output] <i>o C 5</i> - Menu .....	282
	[Profibus] <i>P b C</i> - Menu .....	283
Chapter 8	[File management] <i>F n t</i> - .....	285
	[Transfer config file] <i>t C F</i> - Menu .....	286
	[Factory settings] <i>F C 5</i> - Menu .....	286
	[Parameter group list] <i>F r Y</i> - Menu .....	287
	[Factory settings] <i>F C 5</i> - Menu .....	288
	[Firmware update diag] <i>F W u d</i> - Menu .....	289
Chapter 9	[My preferences] <i>M Y P</i> - .....	291
9.1	[Language] .....	292
	[Language] <i>L n G</i> - Menu .....	292
9.2	[Password] .....	293
	[Password] <i>C o d</i> - Menu .....	293
9.3	[Customization] .....	295
	[Display screen type] <i>M 5 C</i> - Menu .....	295
9.4	[Access level] .....	296
	[Access level] <i>L A C</i> - Menu .....	296
9.5	[LCD settings] .....	297
	[LCD settings] <i>C n L</i> - Menu .....	297
Part III	Maintenance and diagnostics .....	299
Chapter 10	Maintenance .....	301
	Maintenance .....	301

---

<b>Chapter 11</b>	<b>Diagnostics and Troubleshooting</b>	<b>303</b>
11.1	Warning Codes	304
	Warning Codes	304
11.2	Error Codes	305
	Overview	307
11.3	FAQ	346
	FAQ	346







## Important Information

### NOTICE

Read these instructions carefully, and look at the equipment to become familiar with the device before trying to install, operate, service, or maintain it. The following special messages may appear throughout this documentation or on the equipment to warn of potential hazards or to call attention to information that clarifies or simplifies a procedure.



The addition of this symbol to a “Danger” or “Warning” safety label indicates that an electrical hazard exists which will result in personal injury if the instructions are not followed.



This is the safety alert symbol. It is used to alert you to potential personal injury hazards. Obey all safety messages that follow this symbol to avoid possible injury or death.

### **DANGER**

**DANGER** indicates a hazardous situation which, if not avoided, **will result in** death or serious injury.

### **WARNING**

**WARNING** indicates a hazardous situation which, if not avoided, **could result in** death or serious injury.

### **CAUTION**

**CAUTION** indicates a hazardous situation which, if not avoided, **could result in** minor or moderate injury.

### **NOTICE**

**NOTICE** is used to address practices not related to physical injury.

### PLEASE NOTE

Electrical equipment should be installed, operated, serviced, and maintained only by qualified personnel. No responsibility is assumed by Schneider Electric for any consequences arising out of the use of this material.

A qualified person is one who has skills and knowledge related to the construction and operation of electrical equipment and its installation, and has received safety training to recognize and avoid the hazards involved.

### Qualification Of Personnel

Only appropriately trained persons who are familiar with and understand the contents of this manual and all other pertinent product documentation are authorized to work on and with this product. In addition, these persons must have received safety training to recognize and avoid hazards involved. These persons must have sufficient technical training, knowledge and experience and be able to foresee and detect potential hazards that may be caused by using the product, by changing the settings and by the mechanical, electrical and electronic equipment of the entire system in which the product is used. All persons working on and with the product must be fully familiar with all applicable standards, directives, and accident prevention regulations when performing such work.

## Intended Use

This product is a drive for three-phase asynchronous motors and intended for industrial use according to this manual.

The product may only be used in compliance with all applicable safety standard and local regulations and directives, the specified requirements and the technical data. The product must be installed outside the hazardous ATEX zone. Prior to using the product, you must perform a risk assessment in view of the planned application. Based on the results, the appropriate safety measures must be implemented. Since the product is used as a component in an entire system, you must ensure the safety of persons by means of the design of this entire system (for example, machine design). Any use other than the use explicitly permitted is prohibited and can result in hazards.

## Product Related Information

**Read and understand these instructions before performing any procedure with this drive.**

 **DANGER**

**HAZARD OF ELECTRIC SHOCK, EXPLOSION OR ARC FLASH**

- Only appropriately trained persons who are familiar with and understand the contents of this manual and all other pertinent product documentation and who have received safety training to recognize and avoid hazards involved are authorized to work on and with this drive system. Installation, adjustment, repair and maintenance must be performed by qualified personnel.
- The system integrator is responsible for compliance with all local and national electrical code requirements as well as all other applicable regulations with respect to grounding of all equipment.
- Many components of the product, including the printed circuit boards, operate with mains voltage.
- Only use properly rated, electrically insulated tools and measuring equipment.
- Do not touch unshielded components or terminals with voltage present.
- Motors can generate voltage when the shaft is rotated. Prior to performing any type of work on the drive system, block the motor shaft to prevent rotation.
- AC voltage can couple voltage to unused conductors in the motor cable. Insulate both ends of unused conductors of the motor cable.
- Do not short across the DC bus terminals or the DC bus capacitors or the braking resistor terminals.
- Before performing work on the drive system:
  - Disconnect all power, including external control power that may be present. Take into account that the circuit breaker or main switch does not de-energize all circuits.
  - Place a **Do Not Turn On** label on all power switches related to the drive system.
  - Lock all power switches in the open position.
  - Wait 15 minutes to allow the DC bus capacitors to discharge.
  - Follow the instructions given in the chapter "Verifying the Absence of Voltage" in the installation manual of the product.
- Before applying voltage to the drive system:
  - Verify that the work has been completed and that the entire installation cannot cause hazards.
  - If the mains input terminals and the motor output terminals have been grounded and short-circuited, remove the ground and the short circuits on the mains input terminals and the motor output terminals.
  - Verify proper grounding of all equipment.
  - Verify that all protective equipment such as covers, doors, grids is installed and/or closed.

**Failure to follow these instructions will result in death or serious injury.**

Damaged products or accessories may cause electric shock or unanticipated equipment operation.

 **DANGER**

**ELECTRIC SHOCK OR UNANTICIPATED EQUIPMENT OPERATION**

Do not use damaged products or accessories.

**Failure to follow these instructions will result in death or serious injury.**

Contact your local Schneider Electric sales office if you detect any damage whatsoever.

This equipment has been designed to operate outside of any hazardous location. Only install this equipment in zones known to be free of a hazardous atmosphere.

## DANGER

### POTENTIAL FOR EXPLOSION

Install and use this equipment in non-hazardous locations only.

**Failure to follow these instructions will result in death or serious injury.**

Your application consists of a whole range of different interrelated mechanical, electrical, and electronic components, the drive being just one part of the application. The drive by itself is neither intended to nor capable of providing the entire functionality to meet all safety-related requirements that apply to your application. Depending on the application and the corresponding risk assessment to be conducted by you, a whole variety of additional equipment is required such as, but not limited to, external encoders, external brakes, external monitoring devices, guards, etc.

As a designer/manufacturer of machines, you must be familiar with and observe all standards that apply to your machine. You must conduct a risk assessment and determine the appropriate Performance Level (PL) and/or Safety Integrity Level (SIL) and design and build your machine in compliance with all applicable standards. In doing so, you must consider the interrelation of all components of the machine. In addition, you must provide instructions for use that enable the user of your machine to perform any type of work on and with the machine such as operation and maintenance in a safe manner.

The present document assumes that you are fully aware of all normative standards and requirements that apply to your application. Since the drive cannot provide all safety-related functionality for your entire application, you must ensure that the required Performance Level and/or Safety Integrity Level is reached by installing all necessary additional equipment.

## WARNING

### INSUFFICIENT PERFORMANCE LEVEL/SAFETY INTEGRITY LEVEL AND/OR UNINTENDED EQUIPMENT OPERATION

- Conduct a risk assessment according to EN ISO 12100 and all other standards that apply to your application.
- Use redundant components and/or control paths for all critical control functions identified in your risk assessment.
- If moving loads can result in hazards, for example, slipping or falling loads, operate the drive in closed loop mode.
- Verify that the service life of all individual components used in your application is sufficient for the intended service life of your overall application.
- Perform extensive commissioning tests for all potential error situations to verify the effectiveness of the safety-related functions and monitoring functions implemented, for example, but not limited to, speed monitoring by means of encoders, short circuit monitoring for all connected equipment, correct operation of brakes and guards.
- Perform extensive commissioning tests for all potential error situations to verify that the load can be brought to a safe stop under all conditions.

**Failure to follow these instructions can result in death, serious injury, or equipment damage.**

Drive systems may perform unexpected movements because of incorrect wiring, incorrect settings, incorrect data or other errors.

## WARNING

### UNANTICIPATED EQUIPMENT OPERATION

- Carefully install the wiring in accordance with the EMC requirements.
- Do not operate the product with unknown or unsuitable settings or data.
- Perform a comprehensive commissioning test.

**Failure to follow these instructions can result in death, serious injury, or equipment damage.**

## WARNING

### LOSS OF CONTROL

- The designer of any control scheme must consider the potential failure modes of control paths and, for critical control functions, provide a means to achieve a safe state during and after a path failure. Examples of critical control functions are emergency stop, overtravel stop, power outage and restart.
- Separate or redundant control paths must be provided for critical control functions.
- System control paths may include communication links. Consideration must be given to the implications of unanticipated transmission delays or failures of the link.
- Observe all accident prevention regulations and local safety guidelines (1).
- Each implementation of the product must be individually and thoroughly tested for proper operation before being placed into service.

**Failure to follow these instructions can result in death, serious injury, or equipment damage.**

(1) For USA: Additional information, refer to NEMA ICS 1.1 (latest edition), Safety Guidelines for the Application, Installation, and Maintenance of Solid State Control and to NEMA ICS 7.1 (latest edition), Safety Standards for Construction and Guide for Selection, Installation and Operation of Adjustable-Speed Drive Systems.

The temperature of the products described in this manual may exceed 80 °C (176 °F) during operation.

## WARNING

### HOT SURFACES

- Ensure that any contact with hot surfaces is avoided.
- Do not allow flammable or heat-sensitive parts in the immediate vicinity of hot surfaces.
- Verify that the product has sufficiently cooled down before handling it.
- Verify that the heat dissipation is sufficient by performing a test run under maximum load conditions.

**Failure to follow these instructions can result in death, serious injury, or equipment damage.**

Machines, controllers, and related equipment are usually integrated into networks. Unauthorized persons and malware may gain access to the machine as well as to other devices on the network/fieldbus of the machine and connected networks via insufficiently secure access to software and networks.

## WARNING

### UNAUTHORIZED ACCESS TO THE MACHINE VIA SOFTWARE AND NETWORKS

- In your hazard and risk analysis, consider all hazards that result from access to and operation on the network/fieldbus and develop an appropriate cyber security concept.
- Verify that the hardware infrastructure and the software infrastructure into which the machine is integrated as well as all organizational measures and rules covering access to this infrastructure consider the results of the hazard and risk analysis and are implemented according to best practices and standards covering IT security and cyber security (such as: ISO/IEC 27000 series, Common Criteria for Information Technology Security Evaluation, ISO/IEC 15408, IEC 62351, ISA/IEC 62443, NIST Cybersecurity Framework, Information Security Forum - Standard of Good Practice for Information Security).
- Verify the effectiveness of your IT security and cyber security systems using appropriate, proven methods.

**Failure to follow these instructions can result in death, serious injury, or equipment damage.**

## WARNING

### LOSS OF CONTROL

Perform a comprehensive commissioning test to verify that communication monitoring properly detects communication interruptions

**Failure to follow these instructions can result in death, serious injury, or equipment damage.**

---

***NOTICE***

**DESTRUCTION DUE TO INCORRECT MAINS VOLTAGE**

Before switching on and configuring the product, verify that it is approved for the mains voltage.

**Failure to follow these instructions can result in equipment damage.**





---

## At a Glance

### Document Scope

The purpose of this document is to:

- help you to set up the drive,
- show you how to program the drive,
- show you the different menus, modes, and parameters,
- help you in maintenance and diagnostics.

### Validity Note

**NOTE:** The products listed in the document are not all available at the time of publication of this document online. The data, illustrations and product specifications listed in the guide will be completed and updated as the product availabilities evolve. Updates to the guide will be available for download once products are released on the market.

Original instructions and information given in this manual have been written in English (before optional translation).

This documentation is valid for the Altivar 610 drives.

The technical characteristics of the devices described in the present document also appear online. To access the information online:

Step	Action
1	Go to the Schneider Electric home page <a href="http://www.schneider-electric.com">www.schneider-electric.com</a> .
2	In the <b>Search</b> box type the reference of a product or the name of a product range. <ul style="list-style-type: none"><li>• Do not include blank spaces in the reference or product range.</li><li>• To get information on grouping similar modules, use asterisks (*).</li></ul>
3	If you entered a reference, go to the <b>Product Datasheets</b> search results and click on the reference that interests you. If you entered the name of a product range, go to the <b>Product Ranges</b> search results and click on the product range that interests you.
4	If more than one reference appears in the <b>Products</b> search results, click on the reference that interests you.
5	Depending on the size of your screen, you may need to scroll down to see the datasheet.
6	To save or print a datasheet as a .pdf file, click <b>Download XXX product datasheet</b> .

The characteristics that are described in the present document should be the same as those characteristics that appear online. In line with our policy of constant improvement, we may revise content over time to improve clarity and accuracy. If you see a difference between the document and online information, use the online information as your reference.

## Related Documents

Use your tablet or your PC to quickly access detailed and comprehensive information on all our products on [www.schneider-electric.com](http://www.schneider-electric.com).

The internet site provides the information you need for products and solutions:

- The whole catalog for detailed characteristics and selection guides,
- The CAD files to help design your installation, available in over 20 different file formats,
- All software and firmware to maintain your installation up to date,
- A large quantity of White Papers, Environment documents, Application solutions, Specifications... to gain a better understanding of our electrical systems and equipment or automation,
- And finally all the User Guides related to your drive, listed below:

(Other option manuals and Instruction sheets are available on [www.schneider-electric.com](http://www.schneider-electric.com))

Title of Documentation	Catalog Number
Digital Catalog for Industrial Automation	<a href="#">Digit-Cat</a>
Altivar Easy 610 Catalog	<a href="#">DIA2ED2140702EN</a> (English)
ATV610 Getting Started	<a href="#">EAV64374</a> (English), <a href="#">EAV64379</a> (Chinese)
ATV610 Installation Manual	<a href="#">EAV64381</a> (English), <a href="#">EAV64386</a> (Chinese)
ATV610 Programming Manual	<a href="#">EAV64387</a> (English) <a href="#">EAV64393</a> (Chinese)
ATV610 Communication Parameters File	<a href="#">EAV64394</a> (English)
ATV610 Modbus Manual	<a href="#">EAV64395</a> (English)
ATV610 PROFIBUS DP manual	<a href="#">EAV64396</a> (English)

You can download these technical publications and other technical information from our website at [www.schneider-electric.com/en/download](http://www.schneider-electric.com/en/download)

## Terminology

The technical terms, terminology, and the corresponding descriptions in this manual normally use the terms or definitions in the relevant standards.

In the area of drive systems this includes, but is not limited to, terms such as **error**, **error message**, **failure**, **fault**, **fault reset**, **protection**, **safe state**, **safety function**, **warning**, **warning message**, and so on.

Among others, these standards include:

- IEC 61800 series: Adjustable speed electrical power drive systems
- IEC 61508 Ed.2 series: Functional safety of electrical/electronic/programmable electronic safety-related
- EN 954-1 Safety of machinery - Safety related parts of control systems
- EN ISO 13849-1 & 2 Safety of machinery - Safety related parts of control systems.
- IEC 61158 series: Industrial communication networks - Fieldbus specifications
- IEC 61784 series: Industrial communication networks - Profiles
- IEC 60204-1: Safety of machinery - Electrical equipment of machines – Part 1: General requirements

In addition, the term **zone of operation** is used in conjunction with the description of specific hazards, and is defined as it is for a **hazard zone** or **danger zone** in the EC Machinery Directive (2006/42/EC) and in ISO 12100-1.

Also see the glossary at the end of this manual.



---

# Part I

## Introduction

---

### What Is in This Part?

This part contains the following chapters:

Chapter	Chapter Name	Page
1	Setup	19
2	Overview	25



---

# Chapter 1

## Setup

---

### What Is in This Chapter?

This chapter contains the following topics:

Topic	Page
Initial Steps	20
Steps for Setting-Up the Drive	22
Software Enhancements	23

## Initial Steps

### Before Powering up the Drive

<b>⚠ WARNING</b>
<b>UNANTICIPATED EQUIPMENT OPERATION</b> Before switching on the device, verify that no unintended signals can be applied to the digital inputs that could cause unintended movements. <b>Failure to follow these instructions can result in death, serious injury, or equipment damage.</b>

If the drive was not connected to mains for an extended period of time, the capacitors must be restored to their full performance before the motor is started.

<b><i>NOTICE</i></b>
<b>REDUCED CAPACITOR PERFORMANCE</b> <ul style="list-style-type: none"><li>● Apply mains voltage to the drive for one hour before starting the motor if the drive has not been connected to mains for the following periods of time:<ul style="list-style-type: none"><li>○ 12 months at a maximum storage temperature of +50°C (+122°F)</li><li>○ 24 months at a maximum storage temperature of +45°C (+113°F)</li><li>○ 36 months at a maximum storage temperature of +40°C (+104°F)</li></ul></li><li>● Verify that no Run command can be applied before the period of one hour has elapsed.</li><li>● Verify the date of manufacture if the drive is commissioned for the first time and run the specified procedure if the date of manufacture is more than 12 months in the past.</li></ul> <b>Failure to follow these instructions can result in equipment damage.</b>

If the specified procedure cannot be performed without a Run command because of internal mains contactor control, perform this procedure with the power stage enabled, but the motor being at standstill so that there is no appreciable mains current in the capacitors.

### Mains Contactor

<b><i>NOTICE</i></b>
<b>RISK OF DAMAGE TO THE DRIVE</b> Do not switch on the drive at intervals of less than 60 s. <b>Failure to follow these instructions can result in equipment damage.</b>

### Using a Motor with a Lower Rating or Dispensing with a Motor Altogether

In factory settings, the motor output phase loss detection is active: **[OutPhaseLoss Assign] o P L** is set to **[OPF Error Triggered] 5 E 5**. For details, refer to the parameter description (*see page 258*). For commissioning tests or maintenance phase, the drive could be connected to a small motor power size and thus trigger an error **[Output Phase Loss] o P F 2** or **[Single output phase loss] o P F 1** when a Run command is applied. For that purpose, the function can be disabled by setting **[OutPhaseLossAssign] o P L** to **[Function Inactive] n o**.

Set also **[Motor control type] L E E** to **[U/F VC Standard] 5 E d** in **[Motor parameters] P P A -**. For details, refer to the parameter description (*see page 92*).

## NOTICE

### MOTOR OVERHEATING

Install external thermal monitoring equipment under the following conditions:

- If a motor with a nominal current of less than 20% of the nominal current of the drive is connected.
- If you use the function Motor Switching.

**Failure to follow these instructions can result in equipment damage.**

## DANGER

### HAZARD OF ELECTRIC SHOCK, EXPLOSION OR ARC FLASH

If output phase monitoring is disabled, phase loss and, by implication, accidental disconnection of cables, are not detected.

- Verify that the setting of this parameter does not result in unsafe conditions.

**Failure to follow these instructions will result in death or serious injury.**

## Steps for Setting-Up the Drive

# 1 INSTALLATION

Refer to the installation manual.

2 Apply power to the drive without active run command.

3 Configure:

In the [Simply start] *S Y S* - menu, select the [Macro Config] *C F G* configuration compatible with the wiring used.

4 In the [Simply start] *S , 1* - sub menu, adjust the following parameters:

- [Nominal Motor Power] *n P r*
- [Motor Th Current] *i t H* only if the factory configuration of the drive is not suitable
- [Acceleration] *A C C* and [Deceleration] *d E C*
- [Low speed] *L S P* and [High Speed] *H S P*
- [Output Ph Rotation] *P H r*

5 Start the drive.



Drive systems may perform unexpected movements because of incorrect wiring, incorrect settings, incorrect data or other errors.

## ⚠ WARNING

### UNANTICIPATED EQUIPMENT OPERATION

- Carefully install the wiring in accordance with the EMC requirements.
- Do not operate the product with unknown or unsuitable settings or data.
- Perform a comprehensive commissioning test.

Failure to follow these instructions can result in death, serious injury, or equipment damage.

### Tips

Use the [Config. Source] *F C S* , parameter (*see page 286*) to restore the factory settings at any time.

**NOTE:** The following operations must be performed for optimum drive performance in terms of accuracy and response time:

- Enter the values indicated on the motor nameplate in the [Motor parameters] *Π P A* - menu.
- Perform autotuning with the motor cold and connected using the [Autotuning] *t u n* parameter.

## Software Enhancements

### Overview

Since the ATV610 was first launched, it has benefited from the addition of several new functions.

The software version has been updated to V1.6. Although this documentation relates to version V1.6, it can still be used with earlier versions.

### Enhancements Made to Version V1.6. in Comparison to V1.5

Fallback speed response on some error detection is now possible. Refer to the **[Fallback Speed]** *L F F* - menu.

New parameters to display the motor run time and the power-on time in 0.1 hours. Refer to the parameters **[Motor Run Time]** *r t H H* and **[Power-on Time]** *P t H H*.

PID monitoring parameters can be selected to be displayed on the default screen. Refer to the **[Display screen type]** *Π 5 C* - menu.

### Enhancements Made to Version V1.5 in Comparison to V1.4

The setting range of **[Nom Motor Current]** *n C r* and **[Motor Th Current]** *i t H* has been updated.

New menu to display the energy consumption.

**[Overmodul. Activation]** *o v Π Π* parameter has been added in the **[Maintenance]** *C 5 Π Π* - menu.

**[Fan mode]** *F F Π* is forced to **[Never]** *5 t P* on ATV610U07N4 frame size 0.

### Enhancements Made to Version V1.4 in Comparison to V1.3

In the **[My preferences]** *Π 4 P* - menu, the **[Password]** *C o d* - submenu has been added. It allows you to protect the configuration access via a password.

New settings in the **[LCD settings]** *C n L* - menu.

New parameter to configure a delay for the function Sleep Wakeup.

New parameter for the ground fault detection. Refer to the **[Ground Fault]** *G r F L* - menu.

New menu to customize the default screen. Refer to the **[Display screen type]** *Π 5 C* - menu.

### Enhancements Made to Version V1.3 in Comparison to V1.2

In the **[My preferences]** *Π 4 P* menu, the **[LCD settings]** *C n L* - menu has been added.

The default value of several parameters, such a **[Motor control type]** *C t t*, **[R3 assignment]** *r 3* or **[DI1 Delay]** *L 1 d* to **[D16 Delay]** *L 16 d*, has been modified.

The relay R1 can now be assigned for multipump feature.

### Enhancements Made to Version V1.2 in Comparison to V1.1

Improvements of the Sleep Wakeup function.

In the **[Display]** *Π o n* - menu, the **[Application parameters]** *Π P r* - menu has been added.

New functions are available. Refer to the **[Complete Settings]** *C 5 t* - menu.





---

# Chapter 2

## Overview

---

### What Is in This Chapter?

This chapter contains the following topics:

Topic	Page
Factory Configuration	26
Macro Configuration	27
Basic Functions	29
Plain Text Display Terminal	30
Structure of the Parameter Table	32
Finding a Parameter in This Document	33

## Factory Configuration

### Factory Settings

The drive is factory-set for common operating conditions:

- Display: drive ready **[Pre-Ramp Ref Freq] F r H** when motor is ready to run and motor frequency when motor is running.
- The DI3 and DI5 to DI6 digital inputs, AI2 and AI3 analog inputs, R2 and R3 relays are unassigned.
- Stop mode when error detected: freewheel.

This table presents the basic parameters of the drive and their factory setting values:

Code	Name	Factory setting values
<i>b F r</i>	<b>[Motor Standard]</b>	<b>[50Hz IEC] 5 0</b>
<i>r i n</i>	<b>[Reverse Disable]</b>	<b>[Yes] 4 E 5</b>
<i>t c c</i>	<b>[2/3-Wire Control]</b>	<b>[2-Wire Control] 2 c</b> : 2-wire control
<i>c t t</i>	<b>[Motor control type]</b>	<b>[U/F VC Quad.] u F 9</b> : U/F for quadratics loads
<i>A c c</i>	<b>[Acceleration]</b>	30.0 s
<i>d e c</i>	<b>[Deceleration]</b>	30.0 s
<i>L S P</i>	<b>[Low Speed]</b>	0.0 Hz
<i>H S P</i>	<b>[High Speed]</b>	50.0 Hz
<i>i t H</i>	<b>[Motor Th Current]</b>	Nominal motor current (value depending on drive rating)
<i>F r d</i>	<b>[Forward]</b>	<b>[DI1] d i 1</b> : Digital input DI1
<i>F r 1</i>	<b>[Ref Freq 1 Config]</b>	<b>[AI1] A i 1</b> : Analog input AI1
<i>r 1</i>	<b>[R1 Assignment]</b>	<b>[Operating State Fault] F L t</b> : the contact opens when the drive has detected error or when the drive has been switched off
<i>b r A</i>	<b>[Dec.Ramp Adapt]</b>	<b>[Yes] 4 E 5</b> : function active (automatic adaptation of deceleration ramp)
<i>A t r</i>	<b>[Auto Fault Reset]</b>	<b>[No] n o</b> : function inactive
<i>S t t</i>	<b>[Type of stop]</b>	<b>[On Ramp] r n P</b> : on ramp
<i>A a 1</i>	<b>[AQ1 assignment]</b>	<b>[Motor Frequency] a F r</b> : Motor frequency
<i>A a 2</i>	<b>[AQ2 assignment]</b>	<b>[Motor Current] a c r</b> : Motor current

**NOTE:** If you want to restore the drive presets to their factory values, set **[Config. Source] F L 5** to **[Macro Config] i n 1**.

Verify whether the above values are compatible with the application and modify them if required.

## Macro Configuration

### Introduction

The drive offers quick programming using macro configurations that correspond to different applications or uses:

- Start/Stop
- Automatic/Manual control
- PID controller usage
- Preset speeds
- Connection to Modbus fieldbus
- Multi Pump control

Each of these configurations is still configurable.

### Macro Configuration Presets

	[Start/Stop] <i>b 5 t 5</i> (Factory setting)	[Auto/Manual] <i>b A P P</i>	[PID Controller] <i>b P i d</i>	[Preset speeds] <i>b P S P</i>	[Modbus] <i>b P b C</i>	[Multi-pump 1] <i>b P P 1</i>	[Multi-pump 2] <i>b P P 2</i>
[R1 Assignment] <i>r 1</i>	[Operating State Fault] <i>F L t</i>	[Operating State Fault] <i>F L t</i>	[Operating State Fault] <i>F L t</i>	[Operating State Fault] <i>F L t</i>	[Operating State Fault] <i>F L t</i>	[Operating State Fault] <i>F L t</i>	[Operating State Fault] <i>F L t</i>
[R2 Assignment] <i>r 2</i>	[Drive Running] <i>r u n</i>	[Drive Running] <i>r u n</i>	[Drive Running] <i>r u n</i>	[Drive Running] <i>r u n</i>	[Drive Running] <i>r u n</i>	[Pump 2 Cmd] <i>P P o 2</i>	[Pump 1 Cmd] <i>P P o 1</i>
[R3 Assignment] <i>r 3</i>	[Not Assigned] <i>n o</i>	[Not Assigned] <i>n o</i>	[Not Assigned] <i>n o</i>	[Not Assigned] <i>n o</i>	[Not Assigned] <i>n o</i>	[Pump 3 Cmd] <i>P P o 3</i>	[Pump 2 Cmd] <i>P P o 2</i>
[AQ1 assignment] <i>A o 1</i>	[Motor Frequency] <i>a F r</i>	[Motor Frequency] <i>a F r</i>	[Motor Frequency] <i>a F r</i>	[Motor Frequency] <i>a F r</i>	[Motor Frequency] <i>a F r</i>	[Motor Frequency] <i>a F r</i>	[Motor Frequency] <i>a F r</i>
[AQ1 Type] <i>A o 1 t</i>	[Current] <i>D A</i>	[Current] <i>D A</i>	[Current] <i>D A</i>	[Current] <i>D A</i>	[Current] <i>D A</i>	[Current] <i>D A</i>	[Current] <i>D A</i>
[AQ1 min output] <i>A o L 1</i>	4 mA	4 mA	4 mA	4 mA	4 mA	4 mA	4 mA
[AQ1 max output] <i>A o H 1</i>	20 mA	20 mA	20 mA	20 mA	20 mA	20 mA	20 mA
[AQ2 assignment] <i>A o 2</i>	[Motor Current] <i>a C r</i>	[Motor Current] <i>a C r</i>	[Motor Current] <i>a C r</i>	[Motor Current] <i>a C r</i>	[Motor Current] <i>a C r</i>	[Motor Current] <i>a C r</i>	[Motor Current] <i>a C r</i>
[AQ2 Type] <i>A o 2 t</i>	[Current] <i>D A</i>	[Current] <i>D A</i>	[Current] <i>D A</i>	[Current] <i>D A</i>	[Current] <i>D A</i>	[Current] <i>D A</i>	[Current] <i>D A</i>
[AQ2 min output] <i>A o L 2</i>	4 mA	4 mA	4 mA	4 mA	4 mA	4 mA	4 mA
[AQ2 max output] <i>A o H 2</i>	20 mA	20 mA	20 mA	20 mA	20 mA	20 mA	20 mA
[AI1 Type] <i>A i 1 t</i>	[Voltage] <i>I D u</i>	[Voltage] <i>I D u</i>	[Voltage] <i>I D u</i>	[Voltage] <i>I D u</i>	[Voltage] <i>I D u</i>	[Voltage] <i>I D u</i>	[Voltage] <i>I D u</i>
[AI1 min value] <i>u i L 1</i>	0 V	0 V	0 V	0 V	0 V	0 V	0 V
[AI1 max value] <i>u i H 1</i>	10 V	10 V	10 V	10 V	10 V	10 V	10 V
[AI2 Type] <i>A i 2 t</i>	[Current] <i>D A</i>	[Current] <i>D A</i>	[Current] <i>D A</i>	[Current] <i>D A</i>	[Current] <i>D A</i>	[Current] <i>D A</i>	[Current] <i>D A</i>
[AI2 min. value] <i>C r L 2</i>	4 mA	4 mA	4 mA	4 mA	4 mA	4 mA	4 mA

	[Start/Stop] b 5 t 5 (Factory setting)	[Auto/Manual] b A P P	[PID Controller] b P , d	[Preset speeds] b P S P	[Modbus] b P b C	[Multi-pump 1] b P P 1	[Multi-pump 2] b P P 2
[AI2 max. value] C r H 2	20 mA	20 mA	20 mA	20 mA	20 mA	20 mA	20 mA
[Control Mode] C H C F	[Not separ.] S , P	[Not separ.] S , P	[Not separ.] S , P	[Not separ.] S , P	[Separate] S E P	[Not separ.] S , P	[Not separ.] S , P
[Command Switching] C C S	[Cmd Channel 1] C d 1	[Cmd Channel 1] C d 1	[Cmd Channel 1] C d 1	[Cmd Channel 1] C d 1	[Cmd Channel 1] C d 1	[Cmd Channel 1] C d 1	[Cmd Channel 1] C d 1
[Cmd channel 1] C d 1	[Terminals] t E r	[Terminals] t E r	[Terminals] t E r	[Terminals] t E r	[Terminals] t E r	[Terminals] t E r	[Terminals] t E r
[Cmd channel 2] C d 2	[Modbus] P d b	[Modbus] P d b	[Modbus] P d b	[Modbus] P d b	[Modbus] P d b	[Modbus] P d b	[Modbus] P d b
[Freq Switch Assign] r F C	[Ref Freq Channel 1] F r 1	[DI4 Configuration] d , 4	[Ref Freq Channel 1] F r 1	[Ref Freq Channel 1] F r 1	[DI3 Configuration] d , 3	[Ref Freq Channel 1] F r 1	[Ref Freq Channel 1] F r 1
[Ref Freq 1 Config] F r 1	[AI1] A , 1	[AI1] A , 1	[AI1] A , 1	[AI1] A , 1	[Modbus] P d b	[AI1] A , 1	[AI1] A , 1
[Ref Freq 2 Config] F r 2	[Not Configured] n o	[AI2] A , 2	[Not Configured] n o	[Not Configured] n o	[AI1] A , 1	[Not Configured] n o	[Not Configured] n o
[2/3-Wire Control] t C C	[2-Wire Control] 2 C	[2-Wire Control] 2 C	[2-Wire Control] 2 C	[2-Wire Control] 2 C	[2-Wire Control] 2 C	[2-Wire Control] 2 C	[2-Wire Control] 2 C
[Reverse Assign] r r S	[Not Assigned] n o	[DI2 Configuration] d , 2	[Not Assigned] n o	[Not Assigned] n o	[Not Assigned] n o	[Not Assigned] n o	[Not Assigned] n o
[Fault Reset Assign] r S F	[DI2 Configuration] d , 2	[No] n o	[No] n o	[DI2 Configuration] d , 2	[DI2 Configuration] d , 2	[No] n o	[No] n o
[PID feedback] P , F	[No] n o	[No] n o	[AI2] A , 2	[No] n o	[No] n o	[AI2] A , 2	[AI2] A , 2
[2 Preset Freq] P S 2	[Not Assigned] n o	[Not Assigned] n o	[Not Assigned] n o	[DI3 Configuration] d , 3	[Not Assigned] n o	[Not Assigned] n o	[Not Assigned] n o
[4 Preset Freq] P S 4	[Not Assigned] n o	[Not Assigned] n o	[Not Assigned] n o	[DI4 Configuration] d , 4	[Not Assigned] n o	[Not Assigned] n o	[Not Assigned] n o
[Preset speed 2] S P 2	10	10	10	10	10	10	10
[Preset speed 3] S P 3	20	20	20	20	20	20	20
[Preset speed 4] S P 4	30	30	30	30	30	30	30

## Basic Functions

### Drive Ventilation

If **[Fan mode] F F 0** is set to:

- **[Standard] S E 0**, the operation of the fan is enabled when the motor is running. According to drive rating, this could be the only available setting.
- **[Always] r u n**, the fan is always activated.
- **[Economy] E C 0**, the fan is activated only if necessary, according to the internal thermal state of the drive.

**NOTE:** This parameter is forced to **[Never] S E P** on ATV610U07N4 frame size 0.

### ***NOTICE***

#### **OVERHEATING**

Verify that the ambient temperature does not exceed 40 °C (104° F) if the fan is disabled.

**Failure to follow these instructions can result in equipment damage.**

Fan speed and **[Fan Operation Time] F P b t** are monitored values:

- An abnormal low speed of the fan triggers a warning **[Fan Feedback Warning] F F d R**.
- As soon as **[Fan Operation Time] F P b t** reach the predefined value of 45,000 hours, a warning **[Fan Counter Warning] F C t R** is triggered.

**[Fan Operation Time] F P b t** counter can be set to 0 by using the **[Time Counter Reset] r P r** parameter.

## Plain Text Display Terminal

### Description of the Plain Text Display Terminal

This Plain Text Display Terminal is a local control unit which can be either plugged on the drive or mounted on the door of the wall-mounted or floor-standing enclosure. It has a cable with connectors, which is connected to the drive front Modbus serial link.

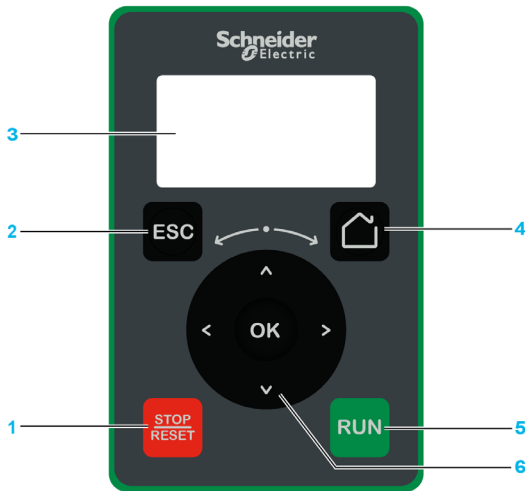

- 1 **STOP / RESET:** Stop command / apply a Fault Reset.
- 2 **ESC:** used to quit a menu/parameter or remove the currently displayed value in order to revert to the previous value retained in the memory
- 3 **Graphic display.**
- 4 **Home:** access directly the home page.
- 5 **RUN:** executes the function assuming it has been configured.
- 6 **Touch wheel / OK:** used to save the current value or access the selected menu/parameter. The touch wheel is used to scroll fast into the menus. Up/down arrows are used for precise selections, right/left arrows are used to select digits when setting a numerical value of a parameter.

**NOTE:** Keys 1, 5 and 6 can be used to control the drive, if control via the Plain Text Display Terminal is activated. To activate the keys on the Plain Text Display Terminal, you first need to set **[Config Ref Freq 1] F r /** to **[Ref.Frequency via Rmt.Term] L C C**.

### Description of the Graphic Display

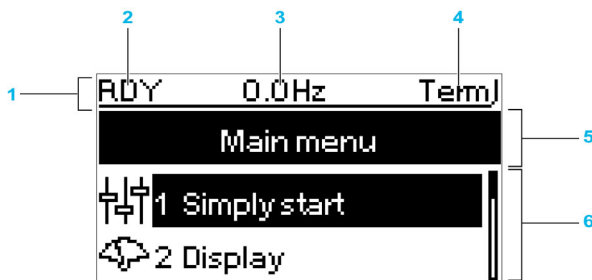

Key	
1	Display line: its content can be configured
2	Drive state
3	Active control channel <ul style="list-style-type: none"> <li>● TERM: terminals</li> <li>● HMI: Plain Text Display Terminal</li> <li>● MDB: integrated Modbus serial</li> <li>● NET: fieldbus module</li> </ul>
4	Customer defined
5	Menu line: indicates the name of the current menu or submenu
6	Menus, submenus, parameters, values, bar charts, and so on, are displayed in drop-down window format on a maximum of 2 lines. The line or value selected by the navigation button is displayed in reverse video

## Description of the Product Front LEDs

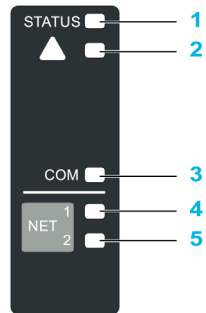

Key	LED color	LED status	Drive status
1	Green	Blinking	Ready
		Flickering	Acceleration or deceleration
		On	Running
2	Red	Blinking	Warning
		On	Operating state fault
3	Yellow	Blinking	Modbus communication active
4	Green	On	Fieldbus module: communication active
5	Red	On	Fieldbus module: communication detected error
		Blinking	Fieldbus module: incorrect settings

## Structure of the Parameter Table

### General Legend

Pictogram	Description
★	These parameters only appear if the corresponding function has been selected in another menu. When the parameters can also be accessed and adjusted from within the configuration menu for the corresponding function, their description is detailed in these menus, on the pages indicated, to aid programming.
⌚	Setting of this parameter can be done during operation or when stopped. <b>NOTE:</b> It is advisable to stop the motor before modifying any of the settings.
⌚	To modify the assignment of the parameter, reinforced validation is required.

### Parameter Presentation

Below is an example of a parameter presentation:

[Sample Menu] C o d E – Menu

#### Access

Parameters described below can be accessed by:

[Path] → [Sub-path]

#### About this menu

Description of the menu or function

[Parameter1] C o d E 1

Description of the parameter

Example of a table with a setting range:

Setting ( )	Description
0.0... 10,000.0	Setting range Factory setting: 50.0

[Parameter2] C o d E 2

Description of the parameter

Example of a table with a list of choices:

Setting ( )	Code / Value	Description
[50 Hz IEC]	5 0	IEC <b>Factory setting</b>
[60 Hz NEMA]	6 0	NEMA



## Finding a Parameter in This Document

### With the Manual

It is possible to use either the parameter name or the parameter code to search in the manual the page giving details of the selected parameter.

### Difference Between Menu and Parameter

A dash after menu and submenu codes is used to differentiate menu commands from parameter codes.

Example:

Level	Name	Code
Menu	[Ramp]	<i>r R P -</i>
Parameter	[Acceleration]	<i>R C C</i>



---

# Part II

## Programming

---

### What Is in This Part?

This part contains the following chapters:

Chapter	Chapter Name	Page
3	[Simply start] <i>S Y S</i> -	37
4	[Display] <i>Π ο η</i> -	43
5	[Diagnostics] <i>δ ι η</i> -	79
6	[Complete settings] <i>Ε Σ Ε</i> -	89
7	[Communication] <i>Ε ο Π</i> -	279
8	[File management] <i>Ε Π Ε</i> -	285
9	[My preferences] <i>Π Υ Ρ</i> -	291



---

# Chapter 3

## [Simply start] 5 4 5 -

---

### Introduction



[Simply start] 5 4 5 - menu contains 3 tabs for quick access to mains features:

- Macro Configuration tab
- Simply Start tab which gives a quick access to basic parameters to set.
- Modified Parameters tab which gives a quick access to the 10 last modified parameters.

### What Is in This Chapter?

This chapter contains the following topics:

Topic	Page
[Macro-configuration] L F G - Menu	38
[Simply start] 5 , 7 - Menu	39
[Modified parameters] L 7 d - Menu	42

**[Macro-configuration]  $\llcorner$   $\llcorner$   $\llcorner$  - Menu****Access**

[Simply start] → [Macro-configuration]

**About This Menu**** WARNING****UNANTICIPATED EQUIPMENT OPERATION**

Verify that the selected macro configuration is compatible with the type of wiring used.

**Failure to follow these instructions can result in death, serious injury, or equipment damage.****[Macro Config]  $\llcorner$   $\llcorner$   $\llcorner$** 

Macro configuration.

Setting	Code / Value	Description
[Start/Stop]	<i>b 5 t 5</i>	Start / Stop <b>Factory setting</b>
[Auto/Manual]	<i>b R n n</i>	Auto / Manual
[PID Controller]	<i>b P i d</i>	PID controller
[Preset speeds]	<i>b P 5 P</i>	Preset speeds
[Modbus]	<i>b n b C</i>	Modbus
[Multi-pump 1]	<i>b n P 1</i>	Multi- pump 1
[Multi-pump 2]	<i>b n P 2</i>	Multi- pump 2

For more information, refer to the macro configuration presets table (*see page 27*).

## [Simply start] 5 , 7 - Menu

### Access

[Simply start] → [Simply start]

### About This Menu

This menu provides a quick access to the basic parameters to set.

 <b>WARNING</b>
<p><b>LOSS OF CONTROL</b></p> <ul style="list-style-type: none"> <li>Fully read and understand the manual of the connected motor.</li> <li>Verify that all motor parameters are correctly set by referring to the nameplate and the manual of the connected motor.</li> </ul> <p><b>Failure to follow these instructions can result in death, serious injury, or equipment damage.</b></p>

### [Nominal motor power] $n P r$ ★

Nominal motor power.

This parameter can be accessed if:

- [Motor param choice]  $n P C$  is set to [Mot Power]  $n P r$ .

Rated motor power given on the nameplate, in kW if [Motor Standard]  $b F r$  is set to [50Hz IEC]  $S D$ , in HP if [Motor Standard]  $b F r$  is set to [60Hz NEMA]  $B D$ .

Setting	Description
According to drive rating	– <b>Factory setting:</b> according to the drive rating

### [Nom Motor Current] $n c r$

The rated motor current is given on the motor nameplate.

Setting (1)	Description
0.25...1.5 In <sup>(1)</sup>	Setting range <b>Factory setting:</b> According to drive rating and [Motor Standard] $b F r$ .
(1) Corresponding to the rated drive current indicated in the installation manual and on the drive nameplate.	

### [Motor Th Current] $i t H$

Motor thermal monitoring current to be set to the rated current indicated on the nameplate.

Setting (1)	Description
0.2...1.1 (1)	Setting range <b>Factory setting:</b> According to drive rating
(1) Corresponding to the rated drive current indicated in the installation manual and on the drive nameplate.	

### [Acceleration] $A C C$

Time to accelerate from 0 to the [Nominal Motor Freq]  $F r 5$ . To have a repeatability in the ramps, the value of this parameter must be set according to the possibility of the application.

Setting (1)	Description
0.0...6,000.0 s <sup>(1)</sup>	Setting range <b>Factory setting:</b> 30.0 s
(1) Range 0.01 to 99.99 s or 0.1 to 999.9 s or 1...6,000 s according to [Ramp increment] $i n r$ .	

**[Deceleration] d E C**

Time to decelerate from the **[Nominal Motor Freq] F r 5** to 0. To have a repeatability in the ramps, the value of this parameter must be set according to the possibility of the application.

Setting (°)	Description
0.0...6,000.0 s <sup>(1)</sup>	Setting range <b>Factory setting:</b> 30.0 s
<b>(1)</b> Range 0.01 to 99.99 s or 0.1 to 999.9 s or 1...6,000 s according to <b>[Ramp increment] i n r</b> .	

**[Low Speed] L 5 P**

Low speed.

Motor frequency at minimum reference, can be set between 0 and **[High Speed] H 5 P**.

Setting (°)	Description
0.0... <b>[High Speed] H 5 P</b> Hz	Setting range <b>Factory setting:</b> 0.0 Hz

**[High Speed] H 5 P**

High speed.

Motor frequency at maximum reference, can be set between **[Low Speed] L 5 P** and **[Max Frequency] E F r**. The factory setting changes to 60 Hz if **[Motor Standard] b F r** is set to **[60Hz NEMA] B D**.

It is recommended to have **[Max Frequency] E F r** equal to or higher than 110% of **[High Speed] H 5 P**.

Setting (°)	Description
0.0... <b>[Max Frequency] E F r</b> Hz	Setting range <b>Factory setting:</b> 50.0 Hz

**[Output Ph Rotation] P H r**

The modification of this parameter has the same consequence as an inversion of two phases of the motor wiring. It allows you to follow color standards for wiring or to adapt the rotation of the motor to the intended forward direction without any electrical wiring modification.

Setting	Code / Value	Description
<b>[ABC]</b>	<i>A b C</i>	Standard rotation <b>Factory Setting</b>
<b>[ACB]</b>	<i>A C b</i>	Opposite rotation

**[Config Ref Freq 1] F r 1**

Configuration reference frequency 1.



Setting	Code / Value	Description
<b>[Not Configured]</b>	<i>n o</i>	Not assigned
<b>[AI1]</b>	<i>A , 1</i>	Analog input AI1 <b>Factory Setting</b>
<b>[AI2]...[AI3]</b>	<i>A , 2...A , 3</i>	Analog input AI2...AI3
<b>[AI4]...[AI5]</b>	<i>A , 4...A , 5</i>	Analog input AI4...AI5 if VW3A3203 I/O extension module has been inserted
<b>[Ref Frequency via Rmt. Term]</b>	<i>L C C</i>	Display terminal source
<b>[Ref Frequency via Modbus]</b>	<i>M d b</i>	Modbus source
<b>[Ref Frequency via Com. Module]</b>	<i>n E t</i>	Fieldbus module source



Setting	Code / Value	Description
[PulseInput Assignment On DI5]...[PulseInput Assignment On DI6]	P 1 5...P 1 6	Digital input DI5...DI6 used as pulse input

### [OutPhaseLoss Assign] $\square$ P L

Output phase loss assignment.

  **DANGER**

**HAZARD OF ELECTRIC SHOCK, EXPLOSION OR ARC FLASH**

If output phase monitoring is disabled, phase loss and, by implication, accidental disconnection of cables, are not detected.

- Verify that the setting of this parameter does not result in unsafe conditions.

**Failure to follow these instructions will result in death or serious injury.**

Setting	Code / Value	Description
[Function Inactive]	n $\square$	Function inactive
[OPF Error Triggered]	Y E 5	Tripping on [OutPhaseLoss Assign] $\square$ P L with freewheel stop <b>Factory setting</b>
[No Error Triggered]	$\square$ R C	No detected error triggered, but management of the output voltage in order to avoid an overcurrent when the link with the motor is re-established and catch on the fly performed (even if this function has not been configured). The drive switches to [Output cut] $\square$ S $\square$ C state after [OutPhL Time] $\square$ d t time. Catch on fly is possible as soon as the drive is in stand by output cut [Output cut] $\square$ S $\square$ C state.

[2/3-wire control] *2 3* 

2-wire or 3-wire control.

**⚠ WARNING**

**UNANTICIPATED EQUIPMENT OPERATION**

If this parameter is changed, the parameters [Reverse Assign] *r r 5* and [2-wire type] *2 3* and the assignments of the digital inputs are reset to the factory setting.

Verify that this change is compatible with the type of wiring used.

**Failure to follow these instructions can result in death, serious injury, or equipment damage.**

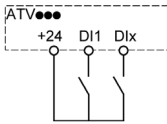
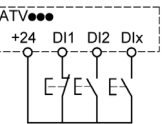
Setting	Code / Value	Description
[2-Wire Control]	<i>2 3</i>	<p><b>2-wire control (level commands):</b> This is the input state (0 or 1) or edge (0 to 1 or 1 to 0), which controls running or stopping.</p> <p>Example of <b>source</b> wiring:</p>  <p><b>DI1</b> Forward <b>DIx</b> Reverse</p> <p><b>Factory setting</b></p>
[3-Wire Control]	<i>3 3</i>	<p><b>3-wire control (pulse commands) [3 wire]:</b> A <b>forward</b> or <b>reverse</b> pulse is sufficient to command starting, a <b>stop</b> pulse is sufficient to command stopping.</p> <p>Example of <b>source</b> wiring:</p>  <p><b>DI1</b> Stop <b>DI2</b> Forward <b>DIx</b> Reverse</p>

[Dual rating] *d r t*

Dual rating state

Settings	Code / Value	Description
[Normal Duty]	<i>n o r P R L</i>	Normal duty
[Heavy Duty]	<i>H I G H</i>	High duty

[Modified parameters] *L P d* - Menu

Access

[Simply start] → [Modified parameters]

About This Menu

This menu gives a quick access to the 10 last modified parameters.

---

# Chapter 4

## [Display] Π ο η -

---

### Introduction



**[Display] Π ο η -** menu shows monitoring data related to the drive and the application.

It offers an application-oriented display in terms of energy, cost, cycle, efficiency, ...

This is available with customized units and graphics view.

### What Is in This Chapter?

This chapter contains the following sections:

Section	Topic	Page
4.1	<b>[Motor parameters]</b>	44
4.2	<b>[Drive parameters]</b>	46
4.3	<b>[I/O map]</b>	49
4.4	Energy parameters	63
4.5	<b>[Communication map]</b>	64
4.6	<b>[Application parameters]</b>	73

## Section 4.1

### [Motor parameters]

#### [Motor parameters] ▯ ▯ ▯ - Menu

##### Access

[Display] → [Motor parameters]

##### About This Menu

This menu shows the motor-related parameters.

#### [Motor Speed] *S P d*

Motor speed.

This parameter displays the estimated rotor speed without motor slip.

Setting	Description
0...65,535 rpm	Setting range <b>Factory setting:</b> -

#### [Motor Voltage] *u o P*

Motor voltage.

Setting	Description
0...65,535 V	Setting range <b>Factory setting:</b> -

#### [Motor Power] *o P r*

Motor power.

Output power in % (100% = nominal motor mechanical power).

Setting	Description
-300...300%	Setting range <b>Factory setting:</b> -

#### [Motor Torque] *o t r*

Motor torque.

Output torque value (100% = Nominal value of motor torque).

**NOTE:** The displayed value is always positive in motor mode and negative in generator mode whatever the direction.

Setting	Description
-300.0... 300.0%	Setting range <b>Factory setting:</b> -

**[Motor Current] L C r**

Motor current.

Setting	Description
0.00...65,535 A	Setting range according to drive ratings <b>Factory setting:</b> –

**[Motor Therm state] L H r**

Motor thermal state.

The normal motor thermal state is 100%, the **[Motor Overload] L F** threshold is set to 118%.

Setting	Description
0...200%	Setting range <b>Factory setting:</b> –

## Section 4.2

### [Drive parameters]

#### [Drive parameters] $\Pi P$ , - Menu

##### Access

[Display] → [Drive parameters]

##### About This Menu

This menu shows the drive-related parameters.

#### [Ref Frequency] $F r H$

Frequency reference before ramp (signed value).

This parameter is read-only. It enables you to display the reference frequency applied to the motor, regardless of which channel for reference value has been selected.

Setting	Description
-500.0...500.0 Hz	Setting range Factory setting: _

#### [Ref Frequency] $L F r$

Reference frequency.

This parameter only appears if the function has been enabled. It is used to change the reference frequency from the remote control. OK does not have to be pressed to enable a change of reference.

Setting ( )	Description
-500.0...500.0 Hz	Setting range Factory setting: 0.0 Hz

#### [Motor Frequency] $r F r$

Motor frequency.

Setting	Description
-3,276.8...3,276.7 Hz	Setting range Factory setting: 0.0 Hz

#### [Mains Voltage] $u L n$

Mains voltage.

Line voltage based on DC bus measurement, motor running or stopped.

Setting	Description
1.0...860.0 V	Setting range: [No meas.] $u L n u n K$ is displayed if no value is measured. Factory setting: _

#### [DC Bus Voltage] $V b u s$

DC bus voltage.

Setting	Description
0...65,535 V	Setting range: [No meas.] $u L n u n K$ is displayed if no value is measured. Factory setting: _

**[Drive Therm State] L H d**

Drive thermal state.

The normal drive thermal state is 100%, the **[Drive Overheating] o H F** threshold is set to 118%

Setting	Description
0...200%	Setting range Factory setting: _

**[Used Param. Set] C F P 5 ★**

Used parameter set.

Configuration parameter status (can be accessed if parameter switching has been enabled).

Setting	Code / Value	Description
[None]	n o	Not assigned
[Set N°1]	C F P 1	Parameter set 1 active
[Set N°2]	C F P 2	Parameter set 2 active
[Set N°3]	C F P 3	Parameter set 3 active

**[Motor Run Time] r L H H**

Motor run time.

Run elapsed time display (resettable) in 0.1 hours (length of time the motor has been switched on).

Setting	Description
0.0...429,496,729.5 h	Setting range Factory setting: _

**[Power-on Time] P L H H**

Power-on time (resettable)

This counter can be set to 0 by using the **[Time Counter Reset] r P r** parameter.

Setting	Description
0.0...429,496,729.5 h	Setting range Factory setting: _

**[IGBT Warning Counter] L H C ★**

IGBT Warning counter.

This parameter can be accessed if **[Access Level] L H C** is set to **[Expert] E P r**

Setting	Description
0...65,535 s	Setting range Factory setting: _

**[PID Reference] r P C ★**

PID reference.

This parameter can be accessed if **[PID Feedback] P , F** is not set to **[Not Configured] n o**.

Setting	Description
0...65,535%	Setting range Factory setting: –

**[PID feedback]  $r_{PF}$  ★**

PID feedback value.

This parameter can be accessed if **[PID Feedback]  $P_i F$**  is not set to **[Not Configured]  $n_a$**

Setting	Description
0...65,535	Setting range Factory setting: 0

**[PID Error]  $r_{PE}$  ★**

PID error value.

This parameter can be accessed if **[PID Feedback]  $P_i F$**  is not set to **[Not Configured]  $n_a$**

Setting	Description
-32,768...32,767	Setting range Factory setting: _

**[PID Output]  $r_{Po}$  ★**

PID output value.

Output value with limitation.

This parameter can be accessed if **[PID Feedback]  $P_i F$**  is not set to **[Not Configured]  $n_a$**

Setting	Description
-3,276.8...3,276.7 Hz	Setting range Factory setting: _



## Section 4.3

### [I/O map]

#### What Is in This Section?

This section contains the following topics:

Topic	Page
[Digital input map] $L, R$ - Menu	50
[AI1] $R, 1C$ - Menu	51
[AI2] $R, 2C$ - Menu	53
[AI3] $R, 3C$ - Menu	54
[AI4] $R, 4C$ - Menu	55
[AI5] $R, 5C$ - Menu	56
[AQ1] $R, 1C$ - Menu	57
[AQ2] $R, 2C$ - Menu	61
[Digital output map] $L, R$ - Menu	62

## [Digital input map] L , H - Menu

### Access

[Display] → [I/O map] → [Digital input map]

### About This Menu

This menu presents the state and assignment of digital inputs.

Read-only parameters, cannot be configured.

It is used to visualize the state of the digital inputs.

It displays all the functions that are assigned to the digital input in order to verify for multiple assignments.

If no functions have been assigned, **[No]**  $\square$  is displayed. Use the touch wheel to scroll through the functions.

## [AI1] *R , I C* - Menu

### Access

[Display] → [I/O map] → [Analog inputs image] → [AI1]

### About This Menu

This menu presents the characteristics of the analog input.

### [AI1] *R , I C*

Physical value AI1.

AI1 customer image: value of analog input 1.

Setting	Description
-32,767...32,767	Setting range Factory setting: _

**NOTE:** The parameters **[AI1 Assignment] *R , I R***, **[AI1 min value] *μ , L I***, **[AI1 max value] *μ , H I*** and **[AI1 filter] *R , I F*** can be accessed on the Plain Text Display Terminal by pressing the **OK** key on the **[AI1] *R , I C*** parameter.

### [AI1 Assignment] *R , I R*

Analog input AI1 functions assignment.

Read-only parameter, cannot be configured. It displays all the functions associated with input AI1 in order to verify, for example, for compatibility problems.

If no functions have been assigned, **[No] *n o*** is displayed.

Setting	Code / Value	Description
<b>[No]</b>	<i>n o</i>	Not assigned
<b>[Ref Freq Channel 1]</b>	<i>F r 1</i>	Reference frequency channel 1 <b>Factory Setting</b>
<b>[Ref Freq Channel 2]</b>	<i>F r 2</i>	Reference frequency channel 2
<b>[PID Feedback]</b>	<i>P , F</i>	PI controller feedback
<b>[Manual PID Ref.]</b>	<i>P , Π</i>	Manual speed reference of the PID controller (auto-man)
<b>[PID Ref Frequency]</b>	<i>F P ,</i>	PID reference frequency
<b>[Forced local]</b>	<i>F L o C</i>	Forced local reference source1
<b>[Inst Flow Assign]</b>	<i>F S I R</i>	Installation flow sensor

### [AI1 min value] *μ , L I* ★

AI1 minimum value.

AI1 voltage scaling parameter of 0%.

This parameter can be accessed if **[AI1 Type] *R , I t*** is set to **[Voltage] *I D μ***.

Setting	Description
0.0...10.0 Vdc	Setting range Factory setting: 0.0 Vdc

**[AI1 max value]  $\mu$  , H / ★**

AI1 maximum value.

AI1 voltage scaling parameter of 100%.

This parameter can be accessed if **[AI1 Type]  $R$  , /  $E$**  is set to **[Voltage] /  $D$   $\mu$** .

Setting	Description
0.0...10.0 Vdc	Setting range <b>Factory setting:</b> 10.0 Vdc

**[AI1 min. value]  $C$  r L / ★**

AI1 minimum value.

AI1 current scaling parameter of 0%.

This parameter can be accessed if **[AI1 Type]  $R$  , /  $E$**  is set to **[Current]  $D$   $R$** .

Setting	Description
0.0...20.0 mA	Setting range <b>Factory setting:</b> 0.0 mA

**[AI1 max. value]  $C$  r H / ★**

AI1 maximum value.

AI1 current scaling parameter of 100%.

This parameter can be accessed if **[AI1 Type]  $R$  , /  $E$**  is set to **[Current]  $D$   $R$** .

Setting	Description
0.0...20.0 mA	Setting range <b>Factory setting:</b> 20.0 mA

**[AI1 filter]  $R$  , /  $F$**

Interference filtering cutoff time of the low-filter.

Setting ( )	Description
0.00...10.00 s	Setting range <b>Factory setting:</b> 0.00 s

## [AI2] *A* , *2* *C* - Menu

### Access

[Display] → [I/O map] → [Analog inputs image] → [AI2]

### About This Menu

This menu presents the characteristics of the analog input.

### [AI2] *A* , *2* *C*

Physical value AI2.

AI2 customer image: value of analog input 2.

Identical to [AI1] *A* , *1* *C* (see page 51).

### [AI2 Assignment] *A* , *2* *A*

Analog input AI2 functions assignment. If no function has been assigned, [No] *n* *a* is displayed.

Identical to [AI1 Assignment] *A* , *1* *A* (see page 51).

### [AI2 min value] *v* , *L* *2* ★

AI2 voltage scaling parameter of 0%.

This parameter can be accessed if [AI2 type] *A* , *2* *E* is set to [Voltage] *V* *D* *v*.

Identical to [AI1 min value] *v* , *L* *1* (see page 51).

### [AI2 max value] *v* , *H* *2* ★

AI2 maximum value.

This parameter can be accessed if [AI2 type] *A* , *2* *E* is set to [Voltage] *V* *D* *v*.

Identical to [AI1 max value] *v* , *H* *1* (see page 52).

### [AI2 min. value] *C* , *r* *L* *2* ★

AI2 current scaling parameter of 0%.

This parameter can be accessed if [AI2 type] *A* , *2* *E* is set to [Current] *D* *A*.

Identical to [AI1 min. value] *C* , *r* *L* *1* (see page 52) with factory setting 4.0 mA.

### [AI2 max. value] *C* , *r* *H* *2* ★

AI2 maximum value.

This parameter can be accessed if [AI2 type] *A* , *2* *E* is set to [Current] *D* *A*.

AI2 current scaling parameter of 100%.

Identical to [AI1 max. value] *C* , *r* *H* *1* (see page 52).

### [AI2 filter] *A* , *2* *F*

Interference filtering.

Identical to [AI1 filter] *A* , *1* *F* (see page 52).

## [AI3] *FI* , *3C* - Menu

### Access

[Display] → [I/O map] → [Analog inputs image] → [AI3]

### About This Menu

This menu presents the characteristics of the analog input.

### [AI3] *FI* , *3C*

Physical value AI3.

AI3 customer image: value of analog input 3.

Identical to [AI1] *FI* , *1C* (*see page 51*).

### [AI3 Assignment] *FI* , *3R*

Analog input AI3 functions assignment. If no function has been assigned, [No] *no* is displayed.

Identical to [AI1 Assignment] *FI* , *1R* (*see page 51*).

### [AI3 min value] *u* , *L3* ★

AI3 voltage scaling parameter of 0%.

This parameter can be accessed if [AI3 type] *FI* , *3E* is set to [Voltage] *UD* .

Identical to [AI1 min value] *u* , *L1* (*see page 51*).

### [AI3 max value] *u* , *H3* ★

AI3 voltage scaling parameter of 100%.

This parameter can be accessed if [AI3 type] *FI* , *3E* is set to [Voltage] *UD* .

Identical to [AI1 max value] *u* , *H1* (*see page 52*).

### [AI3 min. value] *C* , *L3* ★

AI3 current scaling parameter of 0%.

This parameter can be accessed if [AI3 type] *FI* , *3E* is set to [Current] *DR* .

Identical to [AI1 min. value] *C* , *L1* (*see page 52*).

### [AI3 max. value] *C* , *H3* ★

AI3 current scaling parameter of 100%.

This parameter can be accessed if [AI3 type] *FI* , *3E* is set to [Current] *DR* .

Identical to [AI1 max. value] *C* , *H1* (*see page 52*).

### [AI3 filter] *FI* , *3F*

AI3 filter.

Interference filtering.

Identical to [AI1 filter] *FI* , *1F* (*see page 52*).

## [AI4] *A* , *4* *C* - Menu

### Access

[Display] → [I/O map] → [Analog inputs image] → [AI4]

### About This Menu

This menu presents the characteristics of the analog input.  
It can be accessed if VW3A3203 I/O extension module has been inserted.

### [AI4] *A* , *4* *C* ★

Physical value AI4.  
AI4 customer image: value of analog input 4.  
Identical to [AI1] *A* , *1* *C* (see page 51).

### [AI4 Assignment] *A* , *4* *A* ★

Analog input AI4 functions assignment. If no function has been assigned, [No] *n* *o* is displayed.  
Identical to [AI1 Assignment] *A* , *1* *A* (see page 51).

### [AI4 min value] *v* , *L* *4* ★

AI4 voltage scaling parameter of 0%.  
This parameter can be accessed if [AI4 type] *A* , *4* *E* is set to [Voltage] *V* *o* *l* *t* *a* *g* *e* .  
Identical to [AI1 min value] *v* , *L* *1* (see page 51).

### [AI4 max value] *v* , *H* *4* ★

AI4 voltage scaling parameter of 100%.  
This parameter can be accessed if [AI4 type] *A* , *4* *E* is set to [Voltage] *V* *o* *l* *t* *a* *g* *e* .  
Identical to [AI1 max value] *v* , *H* *1* (see page 52).

### [AI4 min. value] *C* , *r* *L* *4* ★

AI4 current scaling parameter of 0%.  
This parameter can be accessed if [AI4 type] *A* , *4* *E* is set to [Current] *C* *u* *r* *r* *e* *n* *t* .  
Identical to [AI1 min. value] *C* , *r* *L* *1* (see page 52).

### [AI4 max. value] *C* , *r* *H* *4* ★

AI4 current scaling parameter of 100%.  
This parameter can be accessed if [AI4 type] *A* , *4* *E* is set to [Current] *C* *u* *r* *r* *e* *n* *t* .  
Identical to [AI1 max. value] *C* , *r* *H* *1* (see page 52).

### [AI4 filter] *A* , *4* *F* ★

Interference filtering cut-off time of the low-filter.  
This parameter can be accessed if [AI4 type] *A* , *4* *E* is set to [Current] *C* *u* *r* *r* *e* *n* *t* .  
Identical to [AI1 filter] *A* , *1* *F* (see page 52).

## [AI5] *A* , *S* *C* - Menu

### Access

[Display] → [I/O map] → [Analog inputs image] → [AI5]

### About This Menu

This menu presents the characteristics of the analog input. It can be accessed if VW3A3203 I/O extension module has been inserted.

### [AI5] *A* , *S* *C* ★

AI5 customer image: value of analog input 5.

Identical to [AI1] *A* , *I* *C* (see page 51).

### [AI5 Assignment] *A* , *S* *A* ★

AI5 functions assignment. If no functions have been assigned, [No] *n* *a* is displayed.

Identical to [AI1 Assignment] *A* , *I* *A* (see page 51).

### [AI5 min value] *v* , *L* *S* ★

AI5 voltage scaling parameter of 0%.

This parameter can be accessed if [AI5 type] *A* , *S* *E* is set to [Voltage] *I* *D* *v*.

Identical to [AI1 min value] *v* , *L* *I* (see page 51).

### [AI5 max value] *v* , *H* *S* ★

AI3 voltage scaling parameter of 100%.

This parameter can be accessed if [AI5 type] *A* , *S* *E* is set to [Voltage] *I* *D* *v*.

Identical to [AI1 max value] *v* , *H* *I* (see page 52).

### [AI5 min. value] *C* *r* *L* *S* ★

AI5 current scaling parameter of 0%.

This parameter can be accessed if [AI5 type] *A* , *S* *E* is set to [Current] *D* *A*.

Identical to [AI1 min. value] *C* *r* *L* *I* (see page 52).

### [AI5 max. value] *C* *r* *H* *S* ★

AI5 current scaling parameter of 100%.

This parameter can be accessed if [AI5 type] *A* , *S* *E* is set to [Current] *D* *A*.

Identical to [AI1 max. value] *C* *r* *H* *I* (see page 52).

### [AI5 filter] *A* , *S* *F* ★

Interference filtering cut-off time of the low-filter.

Identical to [AI1 filter] *A* , *I* *F* (see page 52).



## [AQ1] $P_{\square} I C$ - Menu

### Access

[Display] → [I/O map] → [Analog outputs image] → [AQ1]

### About This Menu

Analogic output functions.

Following parameters can be accessed on the Plain Text Display Terminal by pressing the **OK** key on the [AQ1]  $P_{\square} I C$  parameter.

### Minimum and Maximum Output Values

The minimum output value, in volts, corresponds to the lower limit of the assigned parameter and the maximum value corresponds to its upper limit. The minimum value may be greater than the maximum value.

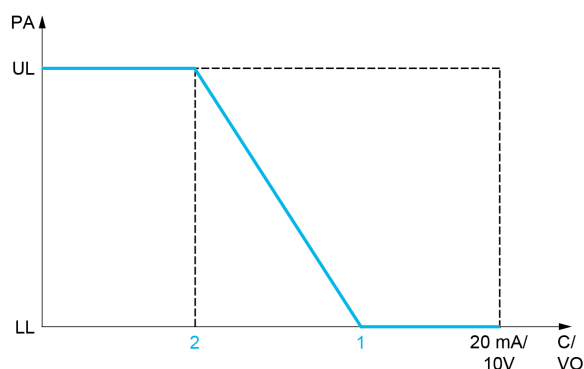
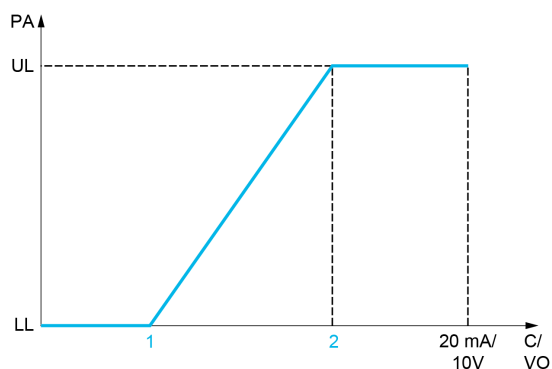

- PA Parameter assigned  
 C / VO Current or voltage output  
 UL Upper limit  
 LL Lower limit  
 1 [Min Output]  $P_{\square} L X$  or  $u_{\square} L X$   
 2 [Max Output]  $P_{\square} H X$  or  $u_{\square} H X$

### Scaling of the Assigned Parameter

The scale of the assigned parameter can be adapted in accordance with requirements by modifying the values of the lower and upper limits with 2 parameters for each analog output.

These parameters are given in %. 100% corresponds to the total variation range of the configured parameter, so: 100% = upper limit - lower limit.

For example, **[Sign. torque] 5 L 9** which varies between -3 and +3 times the rated torque, 100% corresponds to 6 times the rated torque.

- The **[Scaling AQx min] # 5 L X** parameter modifies the lower limit: new value = lower limit + (range x # 5 L X). The value 0% (factory setting) does not modify the lower limit.
- The **[Scaling AQx max] # 5 H X** parameter modifies the upper limit: new value = lower limit + (range x # 5 H X). The value 100% (factory setting) does not modify the upper limit.
- **[Scaling AQx min] # 5 L X** must always be lower than **[Scaling AQx max] # 5 H X**.

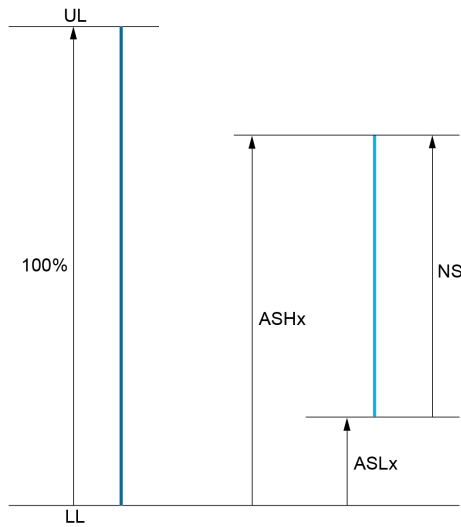

- UL** Upper limit of the assigned parameter
- LL** Lower limit of the assigned parameter
- NS** New scale
  - # 5 H X
  - # 5 L X

### Application Example

The value of the motor current at the AQ1 output is to be transferred with 0...20 mA, range 2 In motor, In motor being the equivalent of a 0.8 In drive.

- The **[Motor Current] 0 C r** parameter varies from 0 to 2 times the rated drive current, or a range of 2.5 times the rated drive current.
- **[Scaling AQ1 min] # 5 L 1** must not modify the lower limit, which therefore remains at its factory setting of 0%.
- **[Scaling AQ1 max] # 5 H 1** must modify the upper limit by 0.5x the rated motor torque, or 100 - 100/5 = 80% (new value = lower limit + (range x ASH1)).

### [AQ1] # 0 1 C

AQ1 customer image: value of analog output 1.

Setting ( )	Description
-32,767...32,767	Setting range Factory setting: _

**[AQ1 Assignment]  $R_{\alpha I}$** 

AQ1 assignment.

Setting	Code / Value	Description
[Not Configured]	$n_{\alpha}$	Not assigned
[Motor Current]	$\alpha L r$	Current in the motor, from 0 to 2 In (In = rated drive current indicated in the Installation manual and on the drive nameplate)
[Motor Frequency]	$\alpha F r$	Output frequency, from 0 to [Max Frequency] $L F r$ <b>Factory Setting</b>
[Ramp out.]	$\alpha r P$	From 0 to [Max Frequency] $L F r$
[Motor torq.]	$L r q$	Motor torque, from 0 to 3 times the rated motor torque
[Sign. torque]	$S L q$	Signed motor torque, between -3 and +3 times the rated motor torque. The + sign corresponds to the motor mode and the - sign to the generator mode (braking).
[sign ramp]	$\alpha r S$	Signed ramp output, between -[Max Frequency] $L F r$ and +[Max Frequency] $L F r$
[PID ref.]	$\alpha P S$	PID controller reference between [Min PID reference] $P_{i P 1}$ and [Max PID reference] $P_{i P 2}$
[PID feedbk]	$\alpha P F$	PID controller feedback between [Min PID feedback] $P_{i F 1}$ and [Max PID feedback] $P_{i F 2}$
[PID error]	$\alpha P E$	PID controller detected error between -5% and +5% of [Max PID feedback] $P_{i F 2}$ - [Min PID feedback] $P_{i F 1}$
[PID output]	$\alpha P i$	PID controller output between [Low speed] $L S P$ and [High speed] $H S P$
[Motor power]	$\alpha P r$	Motor power, between 0 and 2.5 times [Nominal Motor Power] $n P r$
[Mot thermal]	$L H r$	Motor thermal state, from 0 to 200% of the rated thermal state
[Drv thermal]	$L H d$	Drive thermal state, from 0 to 200% of the rated thermal state
[Sig. o/p frq.]	$\alpha F S$	Signed output frequency, between -[Max Frequency] $L F r$ and +[Max Frequency] $L F r$
[Motor volt.]	$u_{\alpha P}$	Voltage applied to the motor, between 0 and [Nom Motor Voltage] $u_{n S}$
[Inlet Pressure Value]	$P S 1 u$	Inlet pressure value
[Outlet Pressure Value]	$P S 2 u$	Outlet pressure value
[Installation Flow]	$F S 1 u$	Installation flow value

**[AQ1 min Output]  $u_{\alpha L} \star$** 

AQ1 minimum output.

This parameter can be accessed if [AQ1 Type]  $R_{\alpha I L}$  is set to [Voltage]  $I D u$ .

Setting	Description
0.0...10.0 Vdc	Setting range <b>Factory setting:</b> 0.0 Vdc

**[AQ1 max Output]  $u_{\alpha H} \star$** 

AQ1 maximum output.

This parameter can be accessed if [AQ1 Type]  $R_{\alpha I L}$  is set to [Voltage]  $I D u$ .

Setting	Description
0.0...10.0 Vdc	Setting range <b>Factory setting:</b> 10.0 Vdc

**[AQ1 min output] *R 0 L I* ★**

AQ1 minimum output.

This parameter can be accessed if **[AQ1 Type] *R 0 I E*** is set to **[Current] *0 R***.

Setting	Description
0.0...20.0 mA	Setting range <b>Factory setting:</b> 4.0 mA

**[AQ1 Max Output] *R 0 H I* ★**

AQ1 maximum output.

This parameter can be accessed if **[AQ1 Type] *R 0 I E*** is set to **[Current] *0 R***.

Setting	Description
0.0...20.0 mA	Setting range <b>Factory setting:</b> 20.0 mA

**[Scaling AQ1 min] *R 5 L I***

Scaling of the lower limit of the assigned parameter, as a % of the maximum possible variation.

Setting	Description
0.0...100.0%	Setting range <b>Factory setting:</b> 0.0%

**[Scaling AQ1 max] *R 5 H I***

Scaling of the upper limit of the assigned parameter, as a % of the maximum possible variation.

Setting	Description
0.0...100.0%	Setting range <b>Factory setting:</b> 100.0%

**[AQ1 Filter] *R 0 I F***

Interference filtering.

Setting	Description
0.00...10.00 s	Setting range <b>Factory setting:</b> 0.00 s

## [AQ2] $F \square \square C$ - Menu

### Access

[Display] → [I/O map] → [Analog outputs image] → [AQ2]

### About This Menu

Analog output functions.

Following parameters are visible on the Plain Text Display Terminal by pressing the  $\square K$  key on the [AQ2]  $F \square \square C$  parameter.

### [AQ2] $F \square \square C$

AQ2 customer image: value of analog output 2.

Identical to [AQ1]  $F \square \square C$  (*see page 58*).

### [AQ2 assignment] $F \square \square$

AQ2 assignment.

Identical to [AQ1 Assignment]  $F \square \square$  (*see page 59*).

### [AQ2 min Output] $\square \square L \square \star$

AQ2 minimum output.

This parameter can be accessed if [AQ2 Type]  $F \square \square E$  is set to [Voltage]  $I \square \square$ .

Identical to [AQ1 min Output]  $\square \square L \square$  (*see page 59*).

### [AQ2 max Output] $\square \square H \square \star$

AQ2 maximum output.

This parameter can be accessed if [AQ2 Type]  $F \square \square E$  is set to [Voltage]  $I \square \square$ .

Identical to [AQ1 max Output]  $\square \square H \square$  (*see page 59*).

### [AQ2 min output] $F \square \square L \square \star$

AQ2 minimum output.

This parameter can be accessed if [AQ2 Type]  $F \square \square E$  is set to [Current]  $\square \square$ .

Identical to [AQ1 min Output]  $F \square \square L \square$  (*see page 60*).

### [AQ2 max output] $F \square \square H \square \star$

AQ2 maximum output.

This parameter can be accessed if [AQ2 Type]  $F \square \square E$  is set to [Current]  $\square \square$ .

Identical to [AQ1 max Output]  $F \square \square H \square$  (*see page 60*).

### [Scaling AQ2 min] $F \square \square L \square$

Scaling of the lower limit of the assigned parameter, as a % of the maximum possible variation.

Identical to [Scaling AQ1 Min]  $F \square \square L \square$  (*see page 60*).

### [Scaling AQ2 max] $F \square \square H \square$

Scaling of the upper limit of the assigned parameter, as a % of the maximum possible variation.

Identical to [Scaling AQ1 max]  $F \square \square H \square$  (*see page 60*).

### [AQ2 Filter] $F \square \square F$

Interference filtering.

Identical to [AQ1 Filter]  $F \square \square F$  (*see page 60*).

## [Digital output map] L R - Menu

### Access

[Display] → [I/O map] → [Digital output map]

### About This Menu

This menu presents the state and assignment of digital outputs.

## Section 4.4

### Energy parameters

#### [Energy parameters] *E n P* - Menu

##### Access

[Display] → [Energy parameters]

##### About This Menu

This menu presents the output mechanical energy data.

#### [Motor Consumption] *Π E 4*

Energy consumption (TWh).

This parameter can be accessed if [Motor Consumption(TWh)] *Π E 4* is not set to 0.

Setting	Description
0...999 TWh	Setting range Factory setting: _

#### [Motor Consumption] *Π E 3*

Energy consumption (GWh).

Setting	Description
0...999 GWh	Setting range Factory setting: _

#### [Motor Consumption] *Π E 2*

Energy consumption (MWh).

Setting	Description
0...999 MWh	Setting range Factory setting: _

#### [Motor Consumption] *Π E 1*

Energy consumption (kWh).

Setting	Description
0...999 kWh	Setting range Factory setting: _

#### [Motor Consumption] *Π E 0*

Energy consumption (Wh).

Setting	Description
0...999 Wh	Setting range Factory setting: _

## Section 4.5

### [Communication map]

#### What Is in This Section?

This section contains the following topics:

Topic	Page
[Communication map] <i>C P P</i> - Menu	65
[Modbus network diag] <i>P n d</i> - Menu	68
[Com. scanner input map] <i>i S R</i> - Menu	69
[Com scan output map] <i>o S R</i> - Menu	70
[Modbus HMI Diag] <i>P d H</i> - Menu	71
[Command word image] <i>C W i</i> - Menu	72
[Freq. ref. word map] <i>r W i</i> - Menu	72



## [Communication map] $\llcorner \llcorner \llcorner$ - Menu

### Access

[Display] → [Communication map]

### [Command Channel] $\llcorner \llcorner \llcorner \llcorner$

Command channel.

Setting	Code / Value	Description
[Terminals]	$\llcorner \llcorner \llcorner$	Terminal block source <b>Factory Setting</b>
[Ref.Freq-Rmt.Term]	$\llcorner \llcorner \llcorner$	Command via Plain Text Display Terminal
[Ref. Freq-Modbus]	$\llcorner \llcorner \llcorner$	Command via Modbus
[Ref. Freq-Com. Module]	$\llcorner \llcorner \llcorner$	Command via fieldbus module if a fieldbus module has been inserted

### [Cmd Register] $\llcorner \llcorner \llcorner$

Command register.

[Control Mode]  $\llcorner \llcorner \llcorner \llcorner$  is not set to [I/O profile]  $\llcorner \llcorner$

Possible values in CiA402 profile, separate, or not separate mode:

Bit	Description, Value
0	Set to 1: "Switch on"/Contactor command
1	Set to 0: "Disable voltage"/Authorization to supply AC power
2	Set to 0: "Quick stop"
3	Set to 1: "Enable operation"/Run command
4 to 6	Reserved (= 0)
7	"Fault reset" acknowledgment active on 0 to 1 rising edge
8	Set to 1: Halt stop according to the [Type Of Stop] $\llcorner \llcorner \llcorner$ parameter without leaving the operation enabled state
9 and 10	Reserved (= 0)
11 to 15	Can be assigned to commands

Possible values in the I/O profile. On state command [2-Wire Control]  $\llcorner \llcorner$ :

Bit	Description, Value
0	Forward (on state) command: 0: No forward command 1: Forward command  <b>NOTE:</b> The assignment of bit 0 cannot be modified. It corresponds to the assignment of the terminals. It can be switched. Bit 0 $\llcorner \llcorner \llcorner \llcorner$ is only active if the channel of this control word is active.
1 to 15	Can be assigned to commands

Possible values in the I/O profile. On edge command [3-Wire Control]  $\llcorner \llcorner$ :

Bit	Description, Value
0	Stop (run authorization): 0: Stop 1: Run is authorized on a forward or reverse command
1	Forward (on 0 to 1 rising edge) command
2 to 15	Can be assigned to commands
<b>NOTE:</b> The assignment of bits 0 and 1 cannot be modified. It corresponds to the assignment of the terminals. It can be switched. Bits 0 $\llcorner \llcorner \llcorner \llcorner$ and 1 $\llcorner \llcorner \llcorner \llcorner$ are only active if the channel of this control word is active.	

**[Ref Freq Channel] r F C C**

Channel of reference frequency.  
 Identical to **[Command Channel] C P d C** (see page 65)

**[Pre-Ramp Ref Freq] F r H**

Frequency reference before ramp (signed value).  
 This parameter is read-only. It enables to display the reference frequency applied to the motor, regardless of which channel for reference value has been selected.

Setting	Description
	Setting range <b>Factory setting:</b> 0 Hz

**[CIA402 State Reg] E L H**

CIA402 State Register.  
 Possible values in CiA402 profile, separate, or not separate mode:

Bit	Description, Value
0	"Ready to switch on", awaiting power section line supply
1	"Switched on", ready
2	"Operation enabled", running
3	Operating detected error state: 0: Inactive 1: Active
4	"Voltage enabled", power section line supply present: 0: Power section line supply unavailable 1: Power section line supply present <b>NOTE:</b> When the drive is powered by the power section only, this bit is always at 1.
5	Quick stop
6	"Switched on disabled", power section line supply locked
7	Warning: 0: No warning 1: Warning
8	Reserved (= 0)
9	Remote: command or reference via the network 0: Command or reference via the Plain Text Display Terminal 1: Command or reference via the network
10	Targets reference reached: 0: The reference is not reached 1: The reference has been reached <b>NOTE:</b> When the drive is in speed mode, this is the speed reference.
11	"Internal limit active", reference outside limits: 0: The reference is within the limits 1: The reference is not within the limits <b>NOTE:</b> When the drive is in speed mode, the limits are defined by the <b>[Low speed] L 5 P</b> and <b>[High speed] H 5 P</b> parameters.
12	Reserved
13	Reserved
14	"Stop key", STOP via stop key: 0: STOP key not pressed 1: Stop triggered by the STOP key on the Plain Text Display Terminal
15	"Direction", direction of rotation: 0: Forward rotation at output 1: Reverse rotation at output
<b>NOTE:</b> The combination of bits 0, 1, 2, 4, 5 and 6 defines the state in the DSP 402 state chart (see the communication manuals).	

Possible values in the I/O profile:

Bit	Description, Value
0	Reserved (= 0 or 1)
1	Ready: 0: Not ready 1: Ready
2	Running: 0: The drive does not start if a reference other than zero is applied 1: Running, if a reference other than zero is applied, the drive can start
3	Operating detected error state: 0: Inactive 1: Active
4	Power section line supply present: 0: Power section line supply unavailable 1: Power section line supply present
5	Reserved (= 1)
6	Reserved (= 0 or 1)
7	Warning 0: No warning 1: Warning
8	Reserved (= 0)
9	Command via a network: 0: Command via the terminals or the Plain Text Display Terminal 1: Command via a network
10	Reference reached: 0: The reference is not reached 1: The reference has been reached
11	Reference outside limits: 0: The reference is within the limits 1: The reference is not within the limits  <b>NOTE:</b> When the drive is in speed mode, the limits are defined by LSP and HSP parameters.
12	Reserved (= 0)
13	Reserved (= 0)
14	Stop via STOP key: 0: STOP key not pressed 1: Stop triggered by the STOP key on the Plain Text Display Terminal
15	Direction of rotation: 0: Forward rotation at output 1: Reverse rotation at output
<b>NOTE:</b> The value is identical in the CiA402 profile and the I/O profile. In the I/O profile, the description of the values is simplified and does not refer to the CiA402 (Drivecom) state chart.	

**[Modbus network diag] П n d - Menu****Access**

[Display] → [Communication map] → [Modbus network diag]

**About This Menu**

Used for the Modbus serial communication port at the bottom of the control block. Refer to the Modbus serial embedded communication manual for a complete description.

**[COM LED] П d b l**

View of the Modbus communication LED.

**[Mdb Frame Nb] П l c t**

Modbus network frames counter: number of processed frames.

Setting	Description
0...65,535	Setting range <b>Factory setting:</b> Read only

**[Mb NET CRC errors] П l e c**

Modbus network CRC error counter: number of CRC errors

Setting	Description
0...65,535	Setting range <b>Factory setting:</b> Read only

## [Com. scanner input map] , 5 H - Menu

### Access

[Display] → [Communication map] → [Modbus network diag] → [Com. scanner input map]

### About This Menu

Used for CANopen® and Modbus network.

### [Com Scan In1 val.] [n p 1](#)

Com scanner input 1 value. Value of the first input word.

Setting	Description
0...65,535	Setting range <b>Factory setting:</b> Read only

### [Com Scan In2 val.] [n p 2](#)

Com scanner input 2 value. Value of the second input word.

Identical to [\[Com Scan In1 val.\] n p 1](#) ([see page 69](#)).

### [Com Scan In3 val.] [n p 3](#)

Com scanner input 3 value. Value of the third input word.

Identical to [\[Com Scan In1 val.\] n p 1](#) ([see page 69](#)).

### [Com Scan In4 val.] [n p 4](#)

Com scanner input 4 value. Value of the fourth input word.

Identical to [\[Com Scan In1 val.\] n p 1](#) ([see page 69](#)).

### [Com Scan In5 val.] [n p 5](#)

Com scanner input 5 value. Value of the fifth input word.

Identical to [\[Com Scan In1 val.\] n p 1](#) ([see page 69](#)).

### [Com Scan In6 val.] [n p 6](#)

Com scanner input 6 value. Value of the sixth input word.

Identical to [\[Com Scan In1 val.\] n p 1](#) ([see page 69](#)).

### [Com Scan In7 val.] [n p 7](#)

Com scanner input 7 value. Value of the seventh input word.

Identical to [\[Com Scan In1 val.\] n p 1](#) ([see page 69](#)).

### [Com Scan In8 val.] [n p 8](#)

Com scanner input 8 value. Value of the eighth input word.

Identical to [\[Com Scan In1 val.\] n p 1](#) ([see page 69](#)).

## [Com scan output map] ▢ 5 H - Menu

### Access

[Display] → [Communication map] → [Com scan output map]

### About This Menu

Used for CANopen® and Modbus networks.

#### [Com Scan Out1 val.] n L 1

Com scanner output 1 value. Value of the first output word.

Setting (↺)	Description
0...65,535	Setting range <b>Factory setting:</b> Read only

#### [Com Scan Out2 val.] n L 2

Com scanner output 2 value. Value of the second output word.

Identical to [Com Scan Out1 val.] n L 1 (*see page 70*).

#### [Com Scan Out3 val.] n L 3

Com scanner output 3 value. Value of the third output word.

Identical to [Com Scan Out1 val.] n L 1 (*see page 70*).

#### [Com Scan Out4 val.] n L 4

Com scanner output 4 value. Value of the fourth output word.

Identical to [Com Scan Out1 val.] n L 1 (*see page 70*).

#### [Com Scan Out5 val.] n L 5

Com scanner output 5 value. Value of the fifth output word.

Identical to [Com Scan Out1 val.] n L 1 (*see page 70*).

#### [Com Scan Out6 val.] n L 6

Com scanner output 6 value. Value of the sixth output word.

Identical to [Com Scan Out1 val.] n L 1 (*see page 70*).

#### [Com Scan Out7 val.] n L 7

Com scanner output 7 value. Value of the seventh output word.

Identical to [Com Scan Out1 val.] n L 1 (*see page 70*).

#### [Com Scan Out8 val.] n L 8

Com scanner output 8 value. Value of the eighth output word.

Identical to [Com Scan Out1 val.] n L 1 (*see page 70*).

## [Modbus HMI Diag] ПДН - Menu

### Access

[Display] → [Communication map] → [Modbus HMI Diag]

### About This Menu

Used for the Modbus serial communication port at the front of the control block (used by the Plain Text Display Terminal)

### [COM LED] ПДБЭ

View of the Modbus HMI communication LED.

### [Mdb NET frames] ПЭЦЕ

Terminal Modbus 2: number of processed frames.

Setting ( )	Description
0...65,535	Setting range <b>Factory setting:</b> Read only

### [Mdb NET CRC errors] ПЭЕК

Terminal Modbus 2: number of CRC errors.

Setting ( )	Description
0...65,535	Setting range <b>Factory setting:</b> Read only

## [Command word image] $\mathcal{L} W \mathcal{I}$ - Menu

### Access

[Display] → [Communication map] → [Command word image]

### About This Menu

Command word image.

### [Modbus Cmd] $\mathcal{L} \mathcal{M} \mathcal{D} \mathcal{I}$

Command word image built with Modbus port source.  
Identical to [CMD Register]  $\mathcal{L} \mathcal{M} \mathcal{D}$  (*see page 65*).

### [COM. Module Cmd.] $\mathcal{L} \mathcal{M} \mathcal{D} \mathcal{E}$

Command word image built with fieldbus module source.  
Identical to [CMD Register]  $\mathcal{L} \mathcal{M} \mathcal{D}$  (*see page 65*).

## [Freq. ref. word map] $\mathcal{L} W \mathcal{I}$ - Menu

### Access

[Display] → [Communication map] → [Freq. ref. word map]

### About This Menu

Frequency reference image.

### [Modbus Ref Freq] $\mathcal{L} F \mathcal{R} \mathcal{I}$

Frequency reference image built with Modbus port source (LFR\_MDB).

Setting $\mathcal{L}$	Description
-32,767...32,767 Hz	Setting range <b>Factory setting:</b> 0.0 Hz

### [Com Module Ref Freq] $\mathcal{L} F \mathcal{R} \mathcal{E}$

Frequency reference image built with fieldbus module source (LFR\_COM).

Setting $\mathcal{L}$	Description
-32,767...32,767 Hz	Setting range <b>Factory setting:</b> 0.0 Hz



---

## Section 4.6

### [Application parameters]

---

#### What Is in This Section?

This section contains the following topics:

Topic	Page
[Variable Speed Pump] <i>VSP</i> - Menu	74
[Booster Control Pump] <i>BCP</i> - Menu	78

## [Variable Speed Pump] *Π P P* - Menu

### Access

[Display] → [Application parameters] → [Variable Speed Pump]

### [Available Pumps] *Π P A n*

Number of available pumps.

This parameter can be accessed if [Pump System Archit] *Π P S A* is set to a value different from [No] *n o*.

Setting	Description
0...65,535	Setting range Factory setting: –

### [Nb of Staged Pumps] *Π P S n*

Number of staged pumps.

This parameter can be accessed if [Pump System Archit] *Π P S A* is set to a value different from [No] *n o*.

Setting	Description
0...65,535	Setting range Factory setting: –

### [Lead Pump] *P L i d*

Lead pump.

Setting	Code / Value	Description
[None]	<i>n o n E</i>	None
[Pump 1]	<i>P 0 1</i>	Pump number 1
[Pump 2]	<i>P 0 2</i>	Pump number 2
[Pump 3]	<i>P 0 3</i>	Pump number 3
[Pump 4]	<i>P 0 4</i>	Pump number 4
[Pump 5]	<i>P 0 5</i>	Pump number 5
[Pump 6]	<i>P 0 6</i>	Pump number 6

### [Next Staged Pump] *P n t 5*

Next pump to stage.

Identical to [Lead Pump] *P L i d* (*see page 74*).

### [Next Destaged Pump] *P n t d*

Next pump to destage.

Identical to [Lead Pump] *P L i d* (*see page 74*).

### [Pump 1 State] *P 1 5* ★

Pump 1 state.

This parameter can be accessed if [Nb Of Pumps] *Π P P n* or [Nb of Devices] *Π P G n* is set to 1 or higher.

Setting	Code / Value	Description
[None]	<i>n o n E</i>	Not configured
[Not Available]	<i>n A u L</i>	Unavailable
[Ready]	<i>r d Y</i>	Ready
[Running]	<i>r u n</i>	Running

**[Pump 1 Type] P 1 E ★**

Pump 1 type.

This parameter can be accessed if **[Nb Of Pumps] Π P P n** or **[Nb of Devices] Π P G n** is set to 1 or higher.

Setting	Code / Value	Description
[None]	n o n E	Undefined
[Lead]	L E A d	Lead pump
[Lead or Auxiliary]	L R F	Lead or auxiliary fixed speed pump
[Lead or Auxiliary Variable]	L R V	Lead or auxiliary variable speed pump
[Auxiliary]	A u X F	Auxiliary fixed speed pump
[Auxiliary Variable]	A u X V	Auxiliary variable speed pump
[Error]	E r r	Error

**[Pump 1 Runtime] P 1 o E ★**

Pump 1 running time.

This parameter can be accessed if **[Nb Of Pumps] Π P P n** or **[Nb of Devices] Π P G n** is set to 1 or higher.

Setting	Description
0...4,294,967,295 s	Setting range Factory setting: –

**[Pump 1 Nb Starts] P 1 n S ★**

Pump 1 number of starts.

This parameter can be accessed if **[Nb Of Pumps] Π P P n** or **[Nb of Devices] Π P G n** is set to 1 or higher.

Setting	Description
0...4,294,967,295 s	Setting range Factory setting: –

**[Pump 2 State] P 2 S ★**

Pump 2 state.

This parameter can be accessed if **[Nb Of Pumps] Π P P n** or **[Nb of Devices] Π P G n** is set to 2 or higher.

Identical to **[Pump 1 State] P 1 S** (*see page 74*).

**[Pump 2 Type] P 2 E ★**

Pump 2 type.

This parameter can be accessed if **[Nb Of Pumps] Π P P n** or **[Nb of Devices] Π P G n** is set to 2 or higher.

Identical to **[Pump 1 Type] P 1 E** (*see page 75*).

**[Pump 2 Runtime] P 2 o E ★**

Pump 2 running time.

This parameter can be accessed if **[Nb Of Pumps] Π P P n** or **[Nb of Devices] Π P G n** is set to 2 or higher.

Identical to **[Pump 1 Runtime] P 1 o E** (*see page 75*).

**[Pump 2 Nb Starts] P 2 n S ★**

Pump 2 number of starts.

This parameter can be accessed if **[Nb Of Pumps] Π P P n** or **[Nb of Devices] Π P G n** is set to 2 or higher.

Identical to **[Pump 1 Nb Starts] P 1 n S** (*see page 75*).

**[Pump 3 State] P 3 5 ★**

Pump 3 state.

This parameter can be accessed if **[Nb Of Pumps] Π P P n** or **[Nb of Devices] Π P G n** is set to 3 or higher.

Identical to **[Pump 1 State] P 1 5** (*see page 74*).

**[Pump 3 Type] P 3 6 ★**

Pump 3 type.

This parameter can be accessed if **[Nb Of Pumps] Π P P n** or **[Nb of Devices] Π P G n** is set to 3 or higher.

Identical to **[Pump 1 Type] P 1 6** (*see page 75*).

**[Pump 3 Runtime] P 3 0 6 ★**

Pump 3 running time.

This parameter can be accessed if **[Nb Of Pumps] Π P P n** or **[Nb of Devices] Π P G n** is set to 3 or higher.

Identical to **[Pump 1 Runtime] P 1 0 6** (*see page 75*).

**[Pump 3 Nb Starts] P 3 n 5 ★**

Pump 3 number of starts.

This parameter can be accessed if **[Nb Of Pumps] Π P P n** or **[Nb of Devices] Π P G n** is set to 3 or higher.

Identical to **[Pump 1 Nb Starts] P 1 n 5** (*see page 75*).

**[Pump 4 State] P 4 5 ★**

Pump 4 state.

This parameter can be accessed if **[Nb Of Pumps] Π P P n** or **[Nb of Devices] Π P G n** is set to 4 or higher.

Identical to **[Pump 1 State] P 1 5** (*see page 74*).

**[Pump 4 Type] P 4 6 ★**

Pump 4 type.

This parameter can be accessed if **[Nb Of Pumps] Π P P n** or **[Nb of Devices] Π P G n** is set to 4 or higher.

Identical to **[Pump 1 Type] P 1 6** (*see page 75*).

**[Pump 4 Runtime] P 4 0 6 ★**

Pump 4 running time.

This parameter can be accessed if **[Nb Of Pumps] Π P P n** or **[Nb of Devices] Π P G n** is set to 4 or higher.

Identical to **[Pump 1 Runtime] P 1 0 6** (*see page 75*).

**[Pump 4 Nb Starts] P 4 n 5 ★**

Pump 4 number of starts.

This parameter can be accessed if **[Nb Of Pumps] Π P P n** or **[Nb of Devices] Π P G n** is set to 4 or higher.

Identical to **[Pump 1 Nb Starts] P 1 n 5** (*see page 75*).

**[Pump 5 State] P 5 5 ★**

Pump 5 state.

This parameter can be accessed if **[Nb Of Pumps] Π P P n** or **[Nb of Devices] Π P G n** is set to 5 or higher.

Identical to **[Pump 1 State] P 1 5** (*see page 74*).

**[Pump 5 Type] P 5 T ★**

Pump 5 type.

This parameter can be accessed if **[Nb Of Pumps]  $\Pi P P n$**  or **[Nb of Devices]  $\Pi P G n$**  is set to 5 or higher.

Identical to **[Pump 1 Type] P 1 T** (*see page 75*).

**[Pump 5 Runtime] P 5 o t ★**

Pump 5 running time.

This parameter can be accessed if **[Nb Of Pumps]  $\Pi P P n$**  or **[Nb of Devices]  $\Pi P G n$**  is set to 5 or higher.

Identical to **[Pump 1 Runtime] P 1 o t** (*see page 75*).

**[Pump 5 Nb Starts] P 5 n S ★**

Pump 5 number of starts.

This parameter can be accessed if **[Nb Of Pumps]  $\Pi P P n$**  or **[Nb of Devices]  $\Pi P G n$**  is set to 5 or higher.

Identical to **[Pump 1 Nb Starts] P 1 n S** (*see page 75*).

**[Pump 6 State] P 6 S ★**

Pump 6 state.

This parameter can be accessed if **[Nb Of Pumps]  $\Pi P P n$**  or **[Nb of Devices]  $\Pi P G n$**  is set to 6.

Identical to **[Pump 1 State] P 1 S** (*see page 74*).

**[Pump 6 Type] P 6 T ★**

Pump 6 type.

This parameter can be accessed if **[Nb Of Pumps]  $\Pi P P n$**  or **[Nb of Devices]  $\Pi P G n$**  is set to 6.

Identical to **[Pump 1 Type] P 1 T** (*see page 75*).

**[Pump 6 Runtime] P 6 o t ★**

Pump 6 running time.

This parameter can be accessed if **[Nb Of Pumps]  $\Pi P P n$**  or **[Nb of Devices]  $\Pi P G n$**  is set to 6.

Identical to **[Pump 1 Runtime] P 1 o t** (*see page 75*).

**[Pump 6 Nb Starts] P 6 n S ★**

Pump 6 number of starts.

This parameter can be accessed if **[Nb Of Pumps]  $\Pi P P n$**  or **[Nb of Devices]  $\Pi P G n$**  is set to 6.

Identical to **[Pump 1 Nb Starts] P 1 n S** (*see page 75*).

**[Booster Control Pump] b C P - Menu**

**Access**

[Display] → [Application parameters] → [Booster Control Pump]

**[Booster Status] b C S**

Booster status.

Setting	Code / Value	Description
[None]	<i>n o n E</i>	Not configured
[Inactive]	<i>n R c t</i>	Inactive
[Running]	<i>r u n</i>	Running
[Stage Pending]	<i>S t G P</i>	Stage pending
[Destage Pending]	<i>d S t G P</i>	Destage pending
[Staging]	<i>S t G</i>	Staging
[Destaging]	<i>d S t G</i>	Destage in progress

---

# Chapter 5

## [Diagnostics] *d , R -*

---

### Introduction



[Diagnostics] *d , R -* menu presents drive and application data useful when diagnostics is required.

### What Is in This Chapter?

This chapter contains the following sections:

Section	Topic	Page
5.1	[Diag. data]	80
5.2	[Error history] <i>P F H -</i> Menu	83
5.3	[Warnings] <i>R L r -</i> Menu	86

## Section 5.1

### [Diag. data]

---

#### What Is in This Section?

This section contains the following topics:

Topic	Page
[Diag. data] <i>d d t</i> - Menu	81
[Other State] <i>5 5 t</i> - Menu	82
[Identification] <i>a i d</i> - Menu	82



## [Diag. data] *d d t* - Menu

### Access

[Diagnostics] → [Diag. data]

### About This Menu

This menu presents the actual warning and detected error in addition to drive data.

### [Last Warning] *L R L r*

Last warning which occurred.

The list of warning codes is available in the chapter "Diagnostics and Troubleshooting" (*see page 304*).

### [Last Error] *L F t*

Last error which occurred.

The list of error codes is available in the chapter "Diagnostics and Troubleshooting" (*see page 305*).

### [Nb Of Start] *n S n*

Number of motor starts (resettable).

Setting	Description
0...4,294,967,295	Setting range Factory setting: 0

### [Motor Run Time] *r t H H*

Motor run time.

Run elapsed time display (resettable) in 0.1 hours (length of time the motor has been switched on).

Setting	Description
0.0...429,496,729.5 h	Setting range Factory setting: _

**[Other State] 5 5 Ƨ - Menu****Access**

[Diagnostics] → [Diag. data] → [Other State]

**About This Menu**

List of secondary states.

**List**

[Anti-Jam pending] *J A P P*  
 [Sleep Active] *S L P*  
 [Sleep Boost active] *S L P b*  
 [Sleep Check Active] *A S L C*  
 [Set 1 active] *C F P 1*  
 [Set 2 active] *C F P 2*  
 [Set 3 active] *C F P 3*  
 [Set 4 active] *C F P 4*  
 [Automatic restart] *A u t o*  
 [DC Bus Charged] *d b L*  
 [Fast stop Active] *F S Ƨ*  
 [Fallback Frequency] *F r F*  
 [Speed Maintained] *r L S*  
 [Type of stop] *S Ƨ Ƨ*  
 [Ref Freq Warning] *S r A*  
 [Forward] *P F r d*  
 [Reverse] *P r r S*  
 [Autotuning] *t u n*

**[Identification] o i d - Menu****Access**

[Diagnostics] → [Diag. data] → [Identification]

**About This Menu**

This is a read-only menu that cannot be configured. It enables the following information to be displayed:

- Drive reference, power rating, and voltage
- Drive software version
- Drive serial number
- Type of option modules present, with their software version
- Plain Text Display Terminal type and version

## Section 5.2

### [Error history] P F H - Menu

#### [Error history] P F H - Menu

##### Access

[Diagnostics] → [Error history]

##### About This Menu

This menu shows the 8 last detected errors (*d P 1* to *d P 8*).

Pressing OK key on the selected error code in the Error history list displays the drive data recorded when the error has been detected.

**NOTE:** Same content for [Last Error 1] *d P 1* to [Last Error 8] *d P 8*.

##### [Last Error 1] *d P 1*

Last error 1.

Identical to [Last Error] *L F E* (see page 81).

##### [Drive State] *H 5 1*

HMI status.

Setting	Code / Value	Description
[Autotuning]	<i>t u n</i>	Autotuning
[In DC inject.]	<i>d C b</i>	Injection braking
[Ready]	<i>r d y</i>	Drive ready
[Freewheel]	<i>n 5 t</i>	Freewheel stop
[Drive Running]	<i>r u n</i>	Motor in steady state or run command present and zero reference
[Accelerating]	<i>A C C</i>	Accelerating
[Decelerating]	<i>d E C</i>	Decelerating
[Current lim.]	<i>C L i</i>	Current limit
[Fast stop]	<i>F 5 t</i>	Fast stop
[Motor fluxing]	<i>F L u</i>	Fluxing function is activated
[no mains V.]	<i>n L P</i>	Control is powered on but the DC bus is not loaded
[control.stop]	<i>C t L</i>	Controlled stop

##### [Last Error 1 Status] *E P 1*

Status of last error 1.

DRIVECOM status register (same as [ETA state word] *E t R*).

##### [ETI state word] *i P 1*

ETI state word.

ETI status register (see the communication parameter file).

##### [Cmd word] *C P P 1*

Cmd word.

Command register (same as [Cmd word] *C P d*).

**[Motor current] L C P I**

Motor current (same as **[Motor Current] L C r**).

Setting	Description
0...2*In <sup>(1)</sup>	Setting range Factory setting: _
<b>(1)</b> Corresponding to the rated drive current indicated in the installation manual and on the drive nameplate.	

**[Output frequency] r F P I**

Output frequency (same as **[Output frequency] r F r**).

Setting	Description
-3,276.7...3,276.7 Hz	Setting range Factory setting: _

**[Elapsed Time] r t P I**

Elapsed time.

Setting	Description
0...65,535 h	Setting range Factory setting: _

**[DC bus voltage] u L P I**

DC bus voltage (same as **[DC bus voltage] V b u 5**).

Setting	Description
0...921 Vdc	Setting range: <b>[No meas.] u L n u n K</b> is displayed if no value is measured. Factory setting: _

**[Motor therm state] t H P I**

Motor thermal state (same as **[Motor Therm state] t H r**).

Setting	Description
0...200%	Setting range Factory setting: _

**[Command Channel] d C C I**

Command channel (same as **[Command channel] C n d C**).

Setting	Code / Value	Description
<b>[Terminals]</b>	t E r	Terminal block
<b>[Ref. Freq-Rmt.Term]</b>	L C C	Plain Text Display Terminal
<b>[Modbus]</b>	n d b	Modbus serial
<b>[Com. Module]</b>	n E t	Fieldbus module

**[Ref Freq Channel] d r C I**

Channel for reference frequency (same as **[Ref Freq Channel] r F C C**).

Identical to **[Command channel] d C C I** (see page 84).

**[Motor Torque] o t P I**

Estimated motor torque value (same as **[Motor Torque] o t r**).

**NOTE:** The displayed value is always positive in motor mode and negative in generator mode whatever the direction.

Setting	Description
-300...300%	Setting range Factory setting: _

### [Drive Thermal State] $\epsilon$ d P I

Measured drive thermal state (same as [Drive Therm State]  $\epsilon$  H d).

Setting	Description
0...200%	Setting range Factory setting: _

### [IGBT Junction Temp] $\epsilon$ J P I

Estimated junction temperature value.

Setting	Description
0...255°C	Setting range Factory setting: _

### [Switching Frequency] $\epsilon$ F P I

Switching frequency applied (related to [Switching Frequency]  $\epsilon$  F r).

Setting	Description
2...12 kHz	Setting range Factory setting: _

### [Last Error 2] $\epsilon$ P 2 to [Last Error 8] $\epsilon$ P 8

Last error 2... Last error 8

Identical to [Last Error1]  $\epsilon$  P I (*see page 83*).

## Section 5.3

### [Warnings] *ALr* - Menu

---

#### What Is in This Section?

This section contains the following topics:

Topic	Page
[Actual warnings] <i>ALrd</i> - Menu	87
[Warnings] <i>ALr</i> - Menu	87

---

## [Actual warnings] *ALr d* - Menu

### Access

[Diagnostics] → [Warnings] → [Actual warnings]

### About This Menu

List of current warnings.

If a warning is active, ✓ and  appears on the Plain Text Display Terminal.

### List of Available Warnings

The list of warning codes is available in the chapter "Diagnostics and Troubleshooting" (*see page 304*).

## [Warnings] *ALr* - Menu

### Access

[Diagnostics] → [Warnings]

### About This Menu

This menu presents the warning history (30 past warnings).

### [Warning History] *ALH*

Identical to [Last warning] *ALr*.





# Chapter 6

## [Complete settings] $\mathcal{L} 5 \mathcal{L} -$

### Introduction



**[Complete settings]  $\mathcal{L} 5 \mathcal{L} -$**  menu presents all the settings related to drive functions for:

- Motor and drive configuration
- Application functions
- Monitoring functions

### What Is in This Chapter?

This chapter contains the following sections:

Section	Topic	Page
6.1	[Motor parameters] $\mathcal{M} P \mathcal{R} -$ Menu	90
6.2	[Input/Output] $\mathcal{I} \mathcal{O} -$ Menu	101
6.3	[Command and Reference] $\mathcal{C} r P -$ Menu	134
6.4	[Generic functions] - [Ramp]	145
6.5	[Generic functions] - [+/- speed]	149
6.6	[Generic functions] - [Stop configuration]	152
6.7	[Generic functions] - [Auto DC injection]	157
6.8	[Generic functions] - [Jog]	160
6.9	[Generic functions] - [Preset speeds]	162
6.10	[Generic functions] - [Jump frequency]	166
6.11	[Generic functions] - [Define system units] $5 \mathcal{U} \mathcal{L} -$ Menu	168
6.12	[Generic functions] - [PID controller]	172
6.13	[Generic functions] - [Sleep/wakeup] $5 P w -$ Menu	192
6.14	[Generic functions] - [Threshold reached]	217
6.15	[Generic functions] - [Mains contactor command]	219
6.16	[Generic functions] - [Parameters switching]	221
6.17	[Generic functions] - [Stop after speed timeout]	225
6.18	[Generic functions] - [Advanced sleep check] $\mathcal{R} d 5 -$ Menu	227
6.19	[Generic functions] - [Booster control]	230
6.20	[Generic monitoring]	242
6.21	[Error/Warning handling]	251
6.22	[Maintenance]	274

# Section 6.1

## [Motor parameters] П P A - Menu

### [Motor parameters] П P A - Menu

**Access**

[Complete settings] → [Motor parameters]

**About This Menu**

⚠ WARNING
<p><b>LOSS OF CONTROL</b></p> <ul style="list-style-type: none"> <li>• Fully read and understand the manual of the connected motor.</li> <li>• Verify that all motor parameters are correctly set by referring to the nameplate and the manual of the connected motor.</li> </ul> <p><b>Failure to follow these instructions can result in death, serious injury, or equipment damage.</b></p>

### [Motor Standard] b F r ★

Motor standard.

This parameter modifies the presets of the following parameters:

- [High Speed] H S P
- [Motor Freq Thd] F t d
- [Nom Motor Voltage] u n 5
- [Nominal Motor Freq] F r 5
- [Max Frequency] t F r

Setting	Code / Value	Description
[50 Hz IEC]	5 0	IEC <b>Factory setting</b>
[60 Hz NEMA]	6 0	NEMA

### [Nominal motor Power] n P r ★

Nominal motor power.

Rated motor power given on the nameplate, in kW if [Motor Standard] b F r is set to [50Hz IEC] 5 0, in HP if [Motor Standard] b F r is set to [60Hz NEMA] 6 0.

Setting	Description
According to drive rating	– <b>Factory setting:</b> according to the drive rating

### [Nom Motor Voltage] u n 5 ★

Nominal motor voltage.

Rated motor voltage given on the nameplate.

Setting	Description
100...690 V	Setting range <b>Factory setting:</b> according to drive rating and [Motor Standard] b F r

**[Nom Motor Current]  $n C r$  ★**

Rated motor current given on the nameplate.

Setting	Description
0.25...1.5 $I_n$ <sup>(1)</sup>	Setting range <b>Factory setting:</b> according to drive rating and <b>[Motor Standard] <math>b F r</math></b>
<b>(1)</b> Corresponding to the rated drive current indicated in the installation manual and on the drive nameplate.	

**[Nominal Motor Freq]  $F r 5$  ★**

Nominal motor frequency.

The factory setting is 50 Hz, or preset to 60 Hz if **[Motor Standard]  $b F r$**  is set to 60 Hz.

Setting	Description
40.0...500.0 Hz	Setting range <b>Factory setting:</b> 50 Hz

**[Nominal Motor Speed]  $n 5 P$  ★**

Nominal motor speed.

If the nameplate indicates the synchronous speed and the slip in Hz or as a %, use any 1 of the formulas to calculate the rated speed:

- Nominal speed = Synchronous speed x  $\frac{100 - \text{slip as a \%}}{100}$
- Nominal speed = Synchronous speed x  $\frac{60 - \text{slip in Hz}}{60}$  (60 Hz motors)
- Nominal speed = Synchronous speed x  $\frac{50 - \text{slip in Hz}}{50}$  (50 Hz motors).

Setting	Description
0...65,535 rpm	Setting range <b>Factory setting:</b> according to drive rating

**[Max Frequency]  $f F r$** 

Maximum output frequency.

The factory setting is 60 Hz, or preset to 72 Hz if **[Motor Standard]  $b F r$**  is set to 60 Hz.

It is recommended to have **[Max Frequency]  $f F r$**  equal to or higher than 110% of **[High Speed]  $H 5 P$** .

Setting	Description
10.0...500.0 Hz	Setting range <b>Factory setting:</b> 60 Hz

**[Motor Th Current]  $i L H$** 

Motor thermal monitoring current to be set to the rated current indicated on the nameplate.

Setting ( )	Description
0.2...1.1 $I_n$ (1)	Setting range <b>Factory setting:</b> According to drive rating
<b>(1)</b> Corresponding to the rated drive current indicated in the installation manual and on the drive nameplate.	

**[Output Ph Rotation] P H r**

Output phase rotation.

Modifying this parameter operates as an inversion of 2 of the 3 motor phases. This results in changing the direction of rotation of the motor.

Setting	Code / Value	Description
[ABC]	A b C	Standard rotation <b>Factory setting</b>
[ACB]	A C b	Opposite rotation

**[Motor Control Type] L L L**

Motor control type.

**NOTE:** Select the motor control type before entering parameter values.

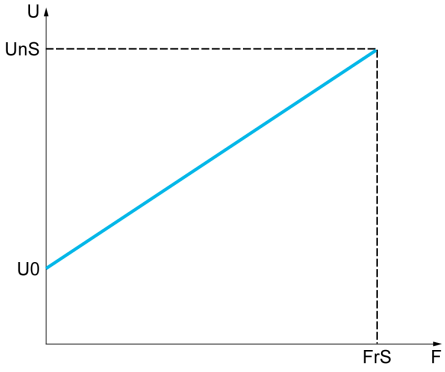
Setting	Code / Value	Description
[U/F VC Standard]	5 L d	<p>Standard motor control type. For applications that require torque at low speed. Simple motor control type keeping a constant Voltage Frequency ratio, with a possible adjustment of the curve bottom. This motor control type is used for motors connected in parallel.</p>  <p><b>Factory setting</b></p> <p><b>NOTE:</b> U0 is the result of an internal calculation based on motor parameters and multiplied by <math>\mu F r</math> (%). U0 can be adjusted by modifying <math>\mu F r</math> value.</p>

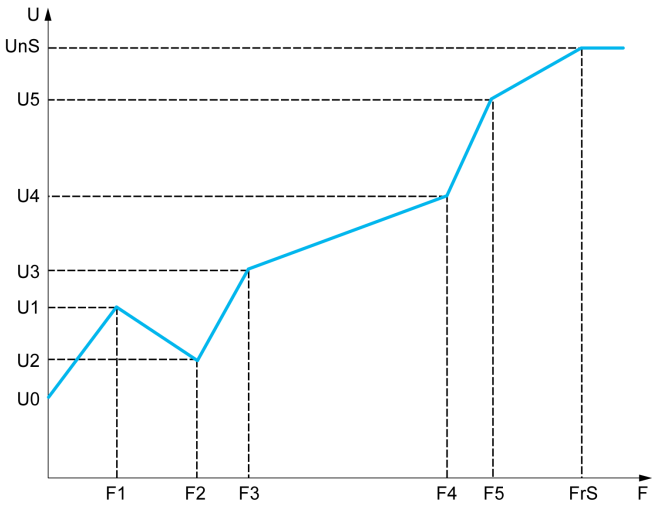
Setting	Code / Value	Description
[U/F VC 5pts]	$\mu F 5$	<p>5-segment V/F profile: As [U/F VC Standard] <math>5 \text{ L d}</math> profile but also supports the avoidance of resonance (saturation).</p>  <p>The profile is defined by the values of parameters <math>U_{nS}</math>, <math>F_{rS}</math>, <math>U_1</math> to <math>U_5</math> and <math>F_1</math> to <math>F_5</math>.  <math>F_{rS} &gt; F_5 &gt; F_4 &gt; F_3 &gt; F_2 &gt; F_1</math></p> <p><b>NOTE:</b> <math>U_0</math> is the result of an internal calculation based on motor parameters and multiplied by <math>\mu F_r</math> (%). <math>U_0</math> can be adjusted by modifying <math>\mu F_r</math> value.</p>
[U/F VC Quad.]	$\mu F 9$	Motor control type dedicated to variable torque applications, typically used for pumps and fans.
[U/F VC Energy Sav.]	$E C 0$	Specific motor control type optimized for energy saving.

### [U/F Profile] PFL ★

U/F profile.

This parameter can be accessed if [Motor Control Type]  $C L E$  is set to [U/F VC Quad.]  $\mu F 9$ .

This parameter is used to adjust the fluxing current level at zero speed, in % of nominal motor current at nominal speed.

Setting ( )	Description
0...100%	Setting range Factory setting: 30%

### [U1] $\mu 1$ ★

Voltage point 1 on 5 points V/F.

This parameter can be accessed if [Motor Control Type]  $C L E$  is set to [V/F 5pts]  $\mu F 5$ .

Setting ( )	Description
0...800 V	Setting range according to rating Factory setting: 0 V

**[F1] F 1** ★

Frequency point 1 on 5 points V/F.

V/F profile setting.

This parameter can be accessed if **[Motor Control Type] C E E** is set to **[V/F 5pts] u F 5**.

Setting ( )	Description
0.0...500.0 Hz	Setting range <b>Factory setting:</b> 0.0 Hz

**[U2] u 2** ★

Voltage point 2 on 5 points V/F.

V/F profile setting.

This parameter can be accessed if **[Motor Control Type] C E E** is set to **[V/F 5pts] u F 5**.

Setting ( )	Description
0...800 V	Setting range according to rating <b>Factory setting:</b> 0 V

**[F2] F 2** ★

Frequency point 2 on 5 points V/F.

V/F profile setting.

This parameter can be accessed if **[Motor Control Type] C E E** is set to **[V/F 5pts] u F 5**.

Setting ( )	Description
0.0...500.0 Hz	Setting range <b>Factory setting:</b> 0.0 Hz

**[U3] u 3** ★

Voltage point 3 on 5 points V/F.

V/F profile setting.

This parameter can be accessed if **[Motor Control Type] C E E** is set to **[V/F 5pts] u F 5**.

Setting ( )	Description
0...800 V	Setting range according to rating <b>Factory setting:</b> 0 V

**[F3] F 3** ★

Frequency point 3 on 5 points V/F.

V/F profile setting.

This parameter can be accessed if **[Motor Control Type] C E E** is set to **[V/F 5pts] u F 5**.

Setting ( )	Description
0.0...500.0 Hz	Setting range <b>Factory setting:</b> 0.0 Hz

**[U4] U 4 ★**

Voltage point on 4 points V/F.

V/F profile setting.

This parameter can be accessed if **[Motor Control Type] C L L** is set to **[V/F 5pts] U F 5**.

Setting ( )	Description
0...800 V	Setting range according to rating <b>Factory setting:</b> 0 V

**[F4] F 4 ★**

Frequency point 4 on 5 points V/F.

V/F profile setting.

This parameter can be accessed if **[Motor Control Type] C L L** is set to **[V/F 5pts] U F 5**.

Setting ( )	Description
0.0...500.0 Hz	Setting range <b>Factory setting:</b> 0.0 Hz

**[U5] U 5 ★**

Voltage point 5 on 5 points V/F.

V/F profile setting.

This parameter can be accessed if **[Motor Control Type] C L L** is set to **[V/F 5pts] U F 5**.

Setting ( )	Description
0...800 V	Setting range according to rating <b>Factory setting:</b> 0 V

**[F5] F 5 ★**

Frequency point 5 on 5 points V/F.

V/F profile setting.

This parameter can be accessed if **[Motor Control Type] C L L** is set to **[V/F 5pts] U F 5**.

Setting ( )	Description
0.0...500.0 Hz	Setting range <b>Factory setting:</b> 0.0 Hz

**[IR compensation] U F r**

This parameter is used to optimize torque at low speed, or to adapt to special cases (for example: for motors connected in parallel, decrease **[IR compensation] U F r**). If there is insufficient torque at low speed, increase **[IR compensation] U F r**. A too high value can avoid the motor to start (locking) or change the current limiting mode.

Setting ( )	Description
0...200%	Setting range <b>Factory setting:</b> 100%

**[Slip compensation] 5 L P ★**

Slip compensation.

This parameter is set to 0% when **[Motor Control Type] C E E** is set to **[U/F VC Quad.] U F 9**.

The speeds given on motor nameplates are not necessarily exact.

If the slip setting is lower than the actual slip, the motor is not rotating at the correct speed in steady state, but at a lower speed than the reference.

If the slip setting is higher than the actual slip, the motor is overcompensated and the speed is unstable.

Setting ( )	Description
0...300%	Setting range <b>Factory setting:</b> 100%

**[Switching frequency] 5 F r**

Drive switching frequency.

<i>NOTICE</i>
<b>DAMAGE TO THE DRIVE</b>
Verify that the switching frequency of the drive does not exceed 4 kHz if the EMC filter is disconnected for operation of the drive in an IT mains.
<b>Failure to follow these instructions can result in equipment damage.</b>

Adjustment range: The maximum value is limited to 4 kHz if **[Motor surge limit.] 5 V L** parameter is configured.

If **[Sinus Filter Activation] o F r** is set to **[Yes] Y E 5**, the minimum value is 2 kHz and the maximum value is limited to 6 kHz or 8 kHz according to drive rating.

**NOTE:** In the event of excessive temperature rise, the drive automatically reduces the switching frequency and reset it once the temperature returns to normal.

In case of high-speed motor, it is advised to increase the PWM frequency **[Switching frequency] 5 F r** at 8, 12 kHz

Setting ( )	Description
2...12 kHz according to drive rating	Setting range <b>Factory setting:</b> 4.0 kHz or 2.5 kHz according to the drive rating

**[Switch Freq Type] 5 F E ★**

Switching frequency type.

This parameter can be accessed if **[Access Level] L A C** is set to **[Expert] E P r**.

The motor switching frequency is modified (reduced) when the internal temperature of the drive is too high.

Setting ( )	Code / Value	Description
<b>[SFR type 1]</b>	<i>H F 1</i>	Heating optimization Allows the system to adapt the switching frequency according to the motor frequency. This setting optimizes the heating loss of the drive in order to improve the drive efficiency. <b>Factory setting</b>
<b>[SFR type 2]</b>	<i>H F 2</i>	Allows the system to keep a constant chosen switching frequency <b>[Switching frequency] 5 F r</b> whatever the motor frequency <b>[Output frequency] r F r</b> . With this setting, the motor noise is kept as low as possible for a high switching frequency. In the event of overheating, the drive automatically decreases the switching frequency. It is restored to its original value when the temperature returns to normal.



**[Noise Reduction] n r d**

Motor noise reduction.

Random frequency modulation helps to prevent any resonance, which may occur at a fixed frequency.

Setting	Code / Value	Description
[No]	n o	Fixed frequency <b>Factory setting</b>
[Yes]	y e s	Frequency with random modulation

**[Motor Surge Limit.] S V L**

Surge voltage limitation.

This function limits motor over voltages and is useful in the following applications:

- NEMA motors
- Old or poor quality motors
- Spindle motors
- Rewound motors

This parameter can remain set to **[No] n o** for 230/400 Vac motors used at 230 Vac, or if the length of cable between the drive and the motor does not exceed:

- 4 m with unshielded cables
- 10 m with shielded cables

**NOTE:** When **[Motor Surge Limit.] S V L** is set to **[Yes] y e s**, the maximum switching frequency **[Switching freq.] S F r** is modified.

Setting	Code / Value	Description
[No]	n o	Function inactive <b>Factory setting</b>
[Yes]	y e s	Function active

**[Attenuation Time] S o P ★**

Attenuation time.

The value of the **[Volt surge limit. opt] S o P** parameter corresponds to the attenuation time of the cable used. It has been defined to prevent the superimposition of voltage wave reflections resulting from long cable lengths. It limits over voltages to twice the DC bus rated voltage.

As surge voltage depends on many parameters such as types of cable, different motor powers in parallel, different cable lengths in parallel, etc., we recommend using an oscilloscope to check the over voltage values obtained at the motor terminals.

For long cable lengths, an output of the filter or a dV/dt filter must be used.

To retain the overall drive performance, do not increase the **S o P** value unnecessarily.

Setting	Code / Value	Description
[6]	6	6 $\mu$ s
[8]	8	8 $\mu$ s <b>Factory setting</b>
[10]	10	10 $\mu$ s

[Current Limitation]  $C L$  , ★

Internal current limit.

<b>NOTICE</b>
<p><b>OVERHEATING</b></p> <ul style="list-style-type: none"> <li>● Verify that the motor is properly rated for the maximum current to be applied to the motor.</li> <li>● Verify that the parameter [Current Limitation] <math>C L</math> , is set to a value lower or equal to the value shown in this table.</li> <li>● Consider the duty cycle of the motor and all factors of your application including derating requirements in determining the current limit.</li> </ul> <p><b>Failure to follow these instructions can result in equipment damage.</b></p>

**NOTE:** If the setting is less than 0.25. In, the drive may lock in [OutPhaseLoss Assign]  $O P L$  if this has been enabled. If it is less than the no-load motor current, the motor cannot run.

Setting (°)	Description
0...1.2 In <sup>(1)</sup>	Setting range <b>Factory setting:</b> 1.2 In <sup>(1)</sup>
(1) The maximum and factory setting value change to 1.5 In if [Dual Rating] $d r E$ is set to [Heavy Duty] $H$ , $G H$ .	

[Autotuning]  $t u n$

<b>⚠ WARNING</b>
<p><b>UNEXPECTED MOVEMENT</b></p> <p>Autotuning moves the motor in order to tune the control loops.</p> <ul style="list-style-type: none"> <li>● Only start the system if there are no persons or obstructions in the zone of operation.</li> </ul> <p><b>Failure to follow these instructions can result in death, serious injury, or equipment damage.</b></p>

During autotuning, the motor makes small movement. Noise development and oscillations of the system are normal.

In any case, the motor has to be stopped before performing a tune operation. Verify that the application does not make the motor turn during the tune operation.

The tune operation optimizes:

- The motor performances at low speed.
- The estimation of the motor torque.
- The accuracy of the estimation of the process values in sensorless operation and monitoring.

Autotuning is only performed if no stop command has been activated. If a “freewheel stop” or “fast stop” function has been assigned to a digital input, this input must be set to 1 (active at 0).

Autotuning takes priority over any run or prefluxing commands, which will be taken into account after the autotuning sequence.

If autotuning has detected error, the drive always displays [No action]  $n o$  and, depending on the configuration of [Tuning Error Resp]  $t n L$  , may switch to [Autotuning]  $t u n$  detected error mode.

Autotuning may last for several seconds. Do not interrupt the process. Wait for the Plain Text Display Terminal to change to [No action]  $n o$  .

**NOTE:** The motor thermal state has a significant influence on the tuning result. Always perform a motor tuning with the motor stopped and cold. Verify that the application does not have the motor operate during a tuning operation.

To redo a motor tuning, wait that it is stopped and cold. Set first [Autotuning]  $t u n$  to [Erase Autotuning]  $C L r$  , then redo the motor tuning.

The use of the motor tuning without doing a [Erase Autotuning]  $C L r$  first is used to get the thermal state estimation of the motor.

The cable length has an influence on the tune result. If the wiring is modified, it is necessary to redo the tune operation.

Setting ( )	Code / Value	Description
[No action]	<i>n o</i>	Autotuning not in progress <b>Factory setting</b>
[Apply Autotuning]	<i>Y E S</i>	Autotuning is performed immediately if possible, then the parameter automatically changes to <b>[No action]</b> <i>n o</i> . If the drive state does not allow the tune operation immediately, the parameter changes to <b>[No]</b> <i>n o</i> and the operation must be done again.
[Erase Autotuning]	<i>C L R</i>	The motor parameters measured by the autotuning function are reset. The default motor parameter values are used to control the motor. <b>[Autotuning Status]</b> <i>t u S</i> is set to <b>[Not done]</b> <i>t R b</i> .

### [Autotuning Status] *t u S*

Autotuning status.

(for information only, cannot be modified)

This parameter is not saved at drive power-off. It shows the autotuning status since the last power-on.

Setting ( )	Code / Value	Description
[Not done]	<i>t R b</i>	The autotuning is not done <b>Factory setting</b>
[Pending]	<i>P E n d</i>	The autotuning has been requested but not yet performed
[In Progress]	<i>P r o G</i>	The autotuning is in progress
[Failed]	<i>F R , L</i>	The autotuning has detected an error
[Done]	<i>d o n E</i>	The motor parameters measured by the autotuning function are used to control the motor

### [Dual rating] *d r t*

Dual rating state

Settings	Code / Value	Description
[Normal Duty]	<i>n o r M R L</i>	Normal duty <b>Factory setting</b>
[Heavy Duty]	<i>H , G H</i>	High duty

### [Boost Activation] *b o A* ★

Boost activation.

Setting	Code / Value	Description
[Inactive]	<i>n o</i>	No boost
[Dynamic]	<i>d Y n A</i>	Dynamic boost, the magnetizing current value is modified according to the motor load. <b>Factory setting</b> <b>NOTE:</b> Drive manages itself the value <b>[Magnetizing Current]</b> <i>i d A</i> to optimize the performances.
[Static]	<i>S t A t</i>	Static boost, the magnetizing current value follows the profile whatever the motor load <b>NOTE:</b> With this selection the <b>[Boost]</b> <i>b o o</i> and <b>[Freq Boost]</b> <i>F R b</i> are taken into account. <b>NOTE:</b> This selection can be used for conical motor with <b>[Boost]</b> <i>b o o</i> sets to a negative value.

**[Boost] b o o** ★

Value at 0 Hz: % of nominal magnetizing current (taken into account if different from 0).

A too high value of **[Boost] b o o** can result in a magnetic saturation of the motor, which leads to a torque reduction.

This parameter can be accessed if:

- **[Boost Activation] b o A** is not set to **[Inactive] n o**.

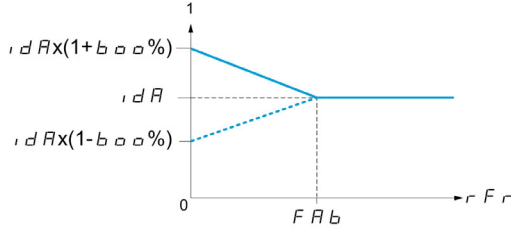

Setting	Description
-100...100%	Setting range If <b>[Boost Activation] b o A</b> is set to <b>[Dynamic] d y n A</b> , <b>[Boost] b o o</b> is set to 25%. <b>Factory setting:</b> 0%

**[Freq Boost] F R b** ★

Value at 0 Hz: speed threshold to reach nominal magnetizing current.

This parameter can be accessed if:

- **[Boost Activation] b o A** is not set to **[NO] n o**, and
- **[Boost Activation] b o A** is not set to **[Constant] C 5 t E**.

Setting	Description
0.0...599.0 Hz	Setting range <b>Factory setting:</b> 30.0 Hz

## Section 6.2

### [Input/Output] , 0 - Menu

#### What Is in This Section?

This section contains the following topics:

Topic	Page
[Input/Output] , 0 - Menu	102
[DI1 Assignment] L , 1 C - Menu	104
[DI2 Assignment] L , 2 C - Menu	105
[DI3 Assignment] L , 3 C - Menu	105
[DI4 Assignment] L , 4 C - Menu	106
[DI5 Assignment] L , 5 C - Menu	106
[DI6 Assignment] L , 6 C - Menu	107
[DI11 Assignment] d , 1 1 - Menu	107
[DI12 Assignment] d , 1 2 - Menu	108
[DI13 Assignment] d , 1 3 - Menu	108
[DI14 Assignment] d , 1 4 - Menu	109
[DI15 Assignment] d , 1 5 - Menu	109
[DI16 Assignment] d , 1 6 - Menu	110
[Input/Output] , 0 - Menu	111
[AI1 configuration] A , 1 - Menu	113
[AI2 configuration] A , 2 - Menu	115
[AI3 configuration] A , 3 - Menu	117
[AI4 configuration] A , 4 - Menu	118
[AI5 configuration] A , 5 - Menu	119
[Virtual AI1] A V 1 - Menu	120
[DQ11 Configuration] d 0 1 1 - Menu	121
[DQ12 Configuration] d 0 1 2 - Menu	123
[R1 configuration] r 1 - Menu	124
[R2 configuration] r 2 - Menu	126
[R3 configuration] r 3 - Menu	127
[R4 configuration] r 4 - Menu	127
[R5 configuration] r 5 - Menu	128
[R6 configuration] r 6 - Menu	128
[AQ1 configuration] A 0 1 - Menu	129
[AQ2 configuration] A 0 2 - Menu	133

[Input/Output] , ▢ - Menu

Access

[Complete settings] → [Input/Output]

[2/3-wire control] ⚡ ⚡ ⚡ ⏳

2-wire or 3-wire control.

<b>⚠ WARNING</b>
<b>UNANTICIPATED EQUIPMENT OPERATION</b>
If this parameter is changed, the parameters [Reverse Assign] ⚡ ⚡ 5 and [2-wire type] ⚡ ⚡ ⚡ and the assignments of the digital inputs are reset to the factory setting.
Verify that this change is compatible with the type of wiring used.
<b>Failure to follow these instructions can result in death, serious injury, or equipment damage.</b>

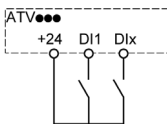
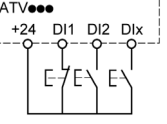
Setting	Code / Value	Description
[2-Wire Control]	2 ⚡	<p><b>2-wire control (level commands):</b> This is the input state (0 or 1) or edge (0 to 1 or 1 to 0), which controls running or stopping.</p> <p>Example of <b>source</b> wiring:</p>  <p><b>DI1</b> Forward <b>DIx</b> Reverse</p> <p><b>Factory setting</b></p>
[3-Wire Control]	3 ⚡	<p><b>3-wire control (pulse commands) [3 wire]:</b> A <b>forward</b> or <b>reverse</b> pulse is sufficient to command starting, a <b>stop</b> pulse is sufficient to command stopping.</p> <p>Example of <b>source</b> wiring:</p>  <p><b>DI1</b> Stop <b>DI2</b> Forward <b>DIx</b> Reverse</p>

[2-wire type] ⚡ ⚡ ⚡ ★ ⏳

Type of 2-wire control.

This parameter can be accessed if [2/3-wire control] ⚡ ⚡ ⚡ is set to [2-Wire Control] 2 ⚡.

<b>⚠ WARNING</b>
<b>UNANTICIPATED EQUIPMENT OPERATION</b>
Verify that the parameter setting is compatible with the type of wiring used.
<b>Failure to follow these instructions can result in death, serious injury, or equipment damage.</b>

Setting	Code / Value	Description
[Level]	L E L	State 0 or 1 is taken into account for run (1) or stop (0)

Setting	Code / Value	Description
[Transition]	<i>Ern</i>	A change of state (transition or edge) is necessary to initiate operation in order to avoid accidental restarts after a break in the supply mains <b>Factory setting</b>
[Level With Fwd Priority]	<i>PFO</i>	State 0 or 1 is taken into account for run or stop, but the “forward” input takes priority over the “reverse” input

**[Reverse Assign] r r 5**

Reverse assignment.

Setting	Code / Value	Description
[Not Assigned]	<i>no</i>	Not assigned <b>Factory setting</b>
[DI1]...[DI6]	<i>L 1...L 6</i>	Digital input DI1...DI6
[DI11]...[DI16]	<i>L 11...L 16</i>	Digital input DI11...DI16 if VW3A3203 I/O extension module has been inserted
[CD00]...[CD10]	<i>C d 0 0...C d 1 0</i>	Virtual digital input CMD.0...CMD.10 in <b>[I/O profile]</b> , <b>o</b> configuration
[CD11]...[CD15]	<i>C d 1 1...C d 1 5</i>	Virtual digital input CMD.11...CMD.15 in <b>[I/O profile]</b> , <b>o</b> configuration
[C101]...[C110]	<i>C 1 0 1...C 1 1 0</i>	Virtual digital input CMD1.01...CMD1.10 with integrated Modbus Serial in <b>[I/O profile]</b> , <b>o</b> configuration
[C111]...[C115]	<i>C 1 1 1...C 1 1 5</i>	Virtual digital input CMD1.11...CMD1.15 with integrated Modbus Serial in <b>[I/O profile]</b> , <b>o</b> configuration
[C301]...[C310]	<i>C 3 0 1...C 3 1 0</i>	Virtual digital input CMD3.01...CMD3.10 with a fieldbus module in <b>[I/O profile]</b> , <b>o</b> configuration
[C311]...[C315]	<i>C 3 1 1...C 3 1 5</i>	Virtual digital input CMD3.11...CMD3.15 with a fieldbus module in <b>[I/O profile]</b> , <b>o</b> configuration

**[DI1 Assignment] L I C - Menu****Access**

[Complete settings] → [Input/Output] → [DI1 Assignment]

**[DI1 Low Assignment] L I L**

DI1 low assignment.

Read-only parameter, cannot be configured. It displays all the functions associated with digital input DI1 in order to verify, for example, for compatibility problems.

If no functions have been assigned, **[No] n o** is displayed.

**[DI1 High Assignment] L I H**

DI1 high assignment.

Read-only parameter, cannot be configured. It displays all the functions associated with digital input DI1 in order to verify, for example, for compatibility problems.

If no functions have been assigned, **[No] n o** is displayed.

The digital input DI1 is assigned to:

- **[Forward] F r d** in 2-wire control
- **[Run] r u n** in 3-wire control.

**[Run] r u n** and **[Forward] F r d** settings cannot be modified manually.

**NOTE:** In IO profile, the assignment of **[Run] r u n** (respectively **[Forward] F r d**) switches to **[CD00] C d 0 0** in 2-wire control (respectively 3-wire control).

**[DI1 Delay] L I d**

DI1 delay.

**NOTE:** Commands received via this digital input are processed once the delay time set via this parameter has elapsed.

Setting	Description
0...200 ms	Setting range <b>Factory setting:</b> 5 ms



## [DI2 Assignment] L 2 C - Menu

### Access

[Complete settings] → [Input/Output] → [DI2 Assignment]

### About This Menu

Identical to [DI1 Assignment] L 1 C - menu (*see page 104*).

### [DI2 Low Assignment] L 2 L

DI2 low assignment.

### [DI2 High Assignment] L 2 H

DI2 high assignment.

The digital input DI2 is assigned to [Forward] F r d in 3-wire control. [Forward] F r d setting cannot be modified manually.

**NOTE:** In IO profile, the assignment of [Forward] F r d switches to [CD01] C d 0 1 in 3-wire control.

### [DI2 Delay] L 2 d

DI2 delay.

## [DI3 Assignment] L 3 C - Menu

### Access

[Complete settings] → [Input/Output] → [DI3 Assignment]

### About This Menu

Identical to [DI1 Assignment] L 1 C - menu (*see page 104*).

### [DI3 Low Assignment] L 3 L

DI3 low assignment.

### [DI3 High Assignment] L 3 H

DI3 high assignment.

### [DI3 Delay] L 3 d

DI3 delay.

## [DI4 Assignment] L , 4 C - Menu

### Access

[Complete settings] → [Input/Output] → [DI4 Assignment]

### About This Menu

Identical to [DI1 Assignment] L , 1 C - menu (*see page 104*).

### [DI4 Low Assignment] L 4 L

DI4 low assignment.

### [DI4 High Assignment] L 4 H

DI4 high assignment.

### [DI4 Delay] L 4 d

DI4 delay.

## [DI5 Assignment] L , 5 C - Menu

### Access

[Complete settings] → [Input/Output] → [DI5 Assignment]

### About This Menu

Identical to [DI1 Assignment] L , 1 C - menu (*see page 104*).

### [DI5 Low Assignment] L 5 L

DI5 low assignment.

### [DI5 High Assignment] L 5 H

DI5 high assignment.

### [DI5 Delay] L 5 d

DI5 delay.

## [DI6 Assignment] L , 6 C - Menu

### Access

[Complete settings] → [Input/Output] → [DI6 Assignment]

### About This Menu

Identical to [DI1 Assignment] L , 1 C - menu (*see page 104*).

### [DI6 Low Assignment] L 6 L

DI6 low assignment.

### [DI6 High Assignment] L 6 H

DI6 high assignment.

### [DI6 Delay] L 6 d

DI6 delay.

## [DI11 Assignment] d , 1 1 - Menu

### Access

[Complete settings] → [Input/Output] → [DI11 Assignment]

### About This Menu

Identical to [DI1 Assignment] L , 1 C - menu (*see page 104*).

Following parameters can be accessed if VW3A3203 I/O extension module has been inserted.

### [DI11 Low Assignment] L 1 1 L ★

DI11 low assignment.

### [DI11 High Assignment] L 1 1 H ★

DI11 high assignment.

### [DI11 Delay] L 1 1 d ★

DI11 delay.

## [DI12 Assignment] $d$ , $12$ - Menu

### Access

[Complete settings] → [Input/Output] → [DI12 Assignment]

### About This Menu

Identical to [DI1 Assignment]  $L$  ,  $11$  - menu (*see page 104*).

Following parameters can be accessed if VW3A3203 I/O extension module has been inserted.

### [DI12 Low Assignment] $L$ $12L$ ★

DI12 low assignment.

### [DI12 High Assignment] $L$ $12H$ ★

DI12 high assignment.

### [DI12 Delay] $L$ $12d$ ★

DI12 delay.

## [DI13 Assignment] $d$ , $13$ - Menu

### Access

[Complete settings] → [Input/Output] → [DI13 Assignment]

### About This Menu

Identical to [DI1 Assignment]  $L$  ,  $11$  - menu (*see page 104*).

Following parameters can be accessed if VW3A3203 I/O extension module has been inserted.

### [DI13 Low Assignment] $L$ $13L$ ★

DI13 low assignment.

### [DI13 High Assignment] $L$ $13H$ ★

DI13 high assignment.

### [DI13 Delay] $L$ $13d$ ★

DI13 delay.

## [DI14 Assignment] *d* , 14 - Menu

### Access

[Complete settings] → [Input/Output] → [DI14 Assignment]

### About This Menu

Identical to [DI1 Assignment] *L* , 1*C* - menu (*see page 104*).

Following parameters can be accessed if VW3A3203 I/O extension module has been inserted.

### [DI14 Low Assignment] *L* 14*L* ★

DI14 low assignment.

### [DI14 High Assignment] *L* 14*H* ★

DI14 high assignment.

### [DI14 Delay] *L* 14*d* ★

DI14 delay.

## [DI15 Assignment] *d* , 15 - Menu

### Access

[Complete settings] → [Input/Output] → [DI15 Assignment]

### About This Menu

Identical to [DI1 Assignment] *L* , 1*C* - menu (*see page 104*).

Following parameters can be accessed if VW3A3203 I/O extension module has been inserted.

### [DI15 Low Assignment] *L* 15*L* ★

DI15 low assignment.

### [DI15 High Assignment] *L* 15*H* ★

DI15 high assignment.

### [DI15 Delay] *L* 15*d* ★

DI15 delay.

## [DI16 Assignment] *d* , *IE* - Menu

### Access

[Complete settings] → [Input/Output] → [DI16 Assignment]

### About This Menu

Identical to [DI1 Assignment] *L* , *IC* - menu (*see page 104*).

Following parameters can be accessed if VW3A3203 I/O extension module has been inserted.

### [DI16 Low Assignment] *L* *IEL* ★

DI16 low assignment.

### [DI16 High Assignment] *L* *IEH* ★

DI16 high assignment.

### [DI16 Delay] *L* *IED* ★

DI16 delay.

**[Input/Output] , ▢ - Menu****Access**

[Complete settings] → [Input/Output]

**[Ref Freq Template] b 5 P**

Low speed management (template).

This parameter defines how the speed reference is taken into account, for analog inputs and pulse input only. In the case of the PID controller, this is the PID output reference.

The limits are set by the [Low speed] L 5 P and [High speed] H 5 P parameters.

Setting ( )	Code / Value	Description
[Standard]	b 5 d	<p><b>F</b> Frequency <b>R</b> Reference</p> <p>At reference = 0, the frequency = [Low speed] L 5 P <b>Factory setting</b></p>
[Pedestal]	b L 5	<p><b>F</b> Frequency <b>R</b> Reference</p> <p>At reference = 0 to [Low speed] L 5 P, the frequency = [Low speed] L 5 P</p>
[Deadband]	b n 5	<p><b>F</b> Frequency <b>R</b> Reference</p> <p>At reference = 0 to LSP the frequency = 0</p>

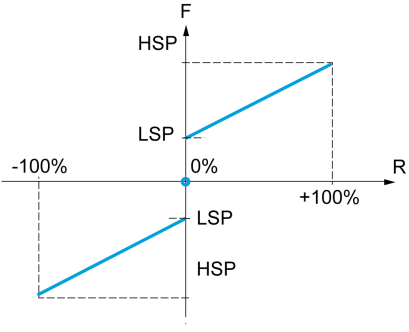
Setting (C)	Code / Value	Description
[Deadband at 0%]	b n 5 d	 <p><b>F</b> Frequency  <b>R</b> Reference</p> <p>This operation is the same as <b>[Standard] b 5 d</b>, except that in the following cases at zero reference, the frequency = 0: The signal is less than <b>[Min nvalue]</b>, which is greater than 0 (example: 1 V on a 2–10 V input) The signal is greater than <b>[Min nvalue]</b>, which is greater than <b>[Max value]</b> (example: 11 V on a 10–0 V input).          If the input range is configured as “bidirectional”, operation remains identical to <b>[Standard] b 5 d</b>.</p>



## [AI1 configuration] R , I - Menu

### Access

[Complete settings] → [Input/Output] → [AI1 configuration]

### About This Menu

The input can be delinearized by configuring an intermediate point on the input/output curve of this input:

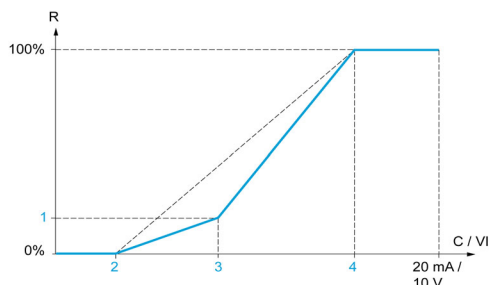

- R Reference  
 C / VI Current or Voltage Input  
 1 [Y Intern. point]  
 2 [Min value] (0%)  
 3 [X Intern. point]  
 4 [Max value] (100%)

**NOTE:** For [X Intern. point], 0% corresponds to [Min value] and 100% to [Max value].

### [AI1 Assignment] R , I R

Analog input AI1 functions assignment.

Read-only parameter, cannot be configured. It displays all the functions associated with input AI1 in order to verify, for example, for compatibility problems.

If no functions have been assigned, [No] n a is displayed.

### [AI1 Type] R , I E

Configuration of analog input AI1.

Setting	Code / Value	Description
[Voltage]	I 0 u	0-10 Vdc <b>Factory setting</b>
[Current]	0 R	0-20 mA

### [AI1 Min. value] u , L I ★

AI1 voltage scaling parameter of 0%.

This parameter can be accessed if [AI1 Type] R , I E is set to [Voltage] I 0 u.

Setting	Description
0.0...10.0 Vdc	Setting range <b>Factory setting:</b> 0.0 Vdc

### [AI1 Max. value] u , H I ★

AI1 voltage scaling parameter of 100%.

This parameter can be accessed if [AI1 Type] R , I E is set to [Voltage] I 0 u.

Setting	Description
0.0...10.0 Vdc	Setting range <b>Factory setting:</b> 10.0 Vdc

**[AI1 Min. value] C r L I ★**

AI1 current scaling parameter of 0%.

This parameter can be accessed if **[AI1 Type] R , I E** is set to **[Current] D R**.

Setting	Description
0.0...20.0 mA	Setting range <b>Factory setting:</b> 0.0 mA

**[AI1 Max. value] C r H I ★**

AI1 current scaling parameter of 100%.

This parameter can be accessed if **[AI1 Type] R , I E** is set to **[Current] D R**.

Setting	Description
0.0...20.0 mA	Setting range <b>Factory setting:</b> 20.0 mA

**[AI1 filter] R , I F**

AI1 cutoff time of the low filter.

Setting ( )	Description
0.00...10.00 s	Setting range <b>Factory setting:</b> 0.00 s

**[AI1 Intern. point X] R , I E**

Input delinearization point coordinate. Percentage of the physical input signal.

0% corresponds to **[AI1 min value] ( u I L , )**

100% corresponds to **[AI1 max value] ( u I H , )**

Setting ( )	Description
0...100%	Setting range <b>Factory setting:</b> 0%

**[AI1 Intern. point Y] R , I S**

Input delinearization point coordinate (frequency reference).

Percentage of the internal frequency reference corresponding to the **[AI1 Intern. point X] ( R , I E )** percentage of physical input signal.

Setting ( )	Description
0...100%	Setting range <b>Factory setting:</b> 0%

## [AI2 configuration] *F* , *2* - Menu

### Access

[Complete settings] → [Input/Output] → [AI2 configuration]

### [AI2 Assignment] *F* , *2* *F*

AI2 functions assignment.

Identical to [AI1 Assignment] *F* , *1* *F* (see page 113).

### [AI2 Type] *F* , *2* *E*

Configuration of analog input AI2.

Setting	Code / Value	Description
[Voltage]	<i>I</i> <i>0</i> <i>u</i>	0-10 Vdc
[Current]	<i>0</i> <i>F</i>	0-20 mA Factory setting
[KTY]	<i>K</i> <i>E</i> <i>Y</i>	1 KTY84 This selection can be accessed if [AIx Th Monitoring] <i>E</i> <i>H</i> <i>X</i> <i>5</i> is not set to [No] <i>n</i> <i>o</i>
[PT1000]	<i>I</i> <i>P</i> <i>E</i> <i>3</i>	1 PT1000 connected with 2 wires This selection can be accessed if [AIx Th Monitoring] <i>E</i> <i>H</i> <i>X</i> <i>5</i> is not set to [No] <i>n</i> <i>o</i>
[PT100]	<i>I</i> <i>P</i> <i>E</i> <i>2</i>	1 PT100 connected with 2 wires This selection can be accessed if [AIx Th Monitoring] <i>E</i> <i>H</i> <i>X</i> <i>5</i> is not set to [No] <i>n</i> <i>o</i>
[3PT1000]	<i>3</i> <i>P</i> <i>E</i> <i>3</i>	3 PT1000 connected with 2 wires This selection can be accessed if [AIx Th Monitoring] <i>E</i> <i>H</i> <i>X</i> <i>5</i> is not set to [No] <i>n</i> <i>o</i>
[3PT100]	<i>3</i> <i>P</i> <i>E</i> <i>2</i>	3 PT100 connected with 2 wires This selection can be accessed if [AIx Th Monitoring] <i>E</i> <i>H</i> <i>X</i> <i>5</i> is not set to [No] <i>n</i> <i>o</i>

### [AI2 min value] *u* , *L* *2* ★

AI2 voltage scaling parameter of 0%.

This parameter can be accessed if [AI2 Type] *F* , *2* *E* is set to [Voltage] *I* *0* *u*.

Identical to [AI1 min value] *u* , *L* *1* (see page 113).

### [AI2 Max .value] *u* , *H* *2* ★

AI2 voltage scaling parameter of 100%.

This parameter can be accessed if [AI2 Type] *F* , *2* *E* is set to [Voltage] *I* *0* *u*.

Identical to [AI1 Max. value] *u* , *H* *1* (see page 113).

### [AI2 Min. value] *C* *r* *L* *2* ★

AI2 current scaling parameter of 0%.

This parameter can be accessed if [AI2 Type] *F* , *2* *E* is set to [Current] *0* *F*.

Identical to [AI1 Min. value] *C* *r* *L* *1* (see page 114) with factory setting: 4.0 mA.

### [AI2 Max. value] *C* *r* *H* *2* ★

AI2 current scaling parameter of 100%.

This parameter can be accessed if [AI2 Type] *F* , *2* *E* is set to [Current] *0* *F*.

Identical to [AI1 Max. value] *C* *r* *H* *1* (see page 114).

**[AI2 filter] R , 2 F**

AI2 filter.

Identical to **[AI1 filter] R , 1 F** (*see page 114*).

**[AI2 Interm. point X] R , 2 E**

AI2 delinearization input level.

Identical to **[AI1 Interm. point X] R , 1 E** (*see page 114*).

**[AI2 Interm. point Y] R , 2 S**

AI2 delinearization output level.

Identical to **[AI1 Interm. point Y] R , 1 S** (*see page 114*).

## [AI3 configuration] *R* , *3* - Menu

### Access

[Complete settings] → [Input/Output] → [AI3 configuration]

### [AI3 Assignment] *R* , *3* *R*

AI3 functions assignment.

Identical to [AI1 Assignment] *R* , *1* *R* (*see page 113*).

### [AI3 Type] *R* , *3* *L*

Configuration of analog input AI3.

Identical to [AI2 Type] *R* , *2* *L* (*see page 115*).

### [AI3 Min. value] *U* , *L* *3* ★

AI3 voltage scaling parameter of 0%.

Identical to [AI1 Min. value] *U* , *L* *1* (*see page 113*).

This parameter can be accessed if [AI3 Type] *R* , *3* *L* is set to [Voltage] *1* *0* *U*.

### [AI3 Max. value] *U* , *H* *3* ★

AI3 voltage scaling parameter of 100%.

Identical to [AI1 Max. value] *U* , *H* *1* (*see page 113*).

This parameter can be accessed if [AI3 Type] *R* , *3* *L* is set to [Voltage] *1* *0* *U*.

### [AI3 Min. value] *C* , *L* *3* ★

AI3 current scaling parameter of 0%.

Identical to [AI1 Min. value] *C* , *L* *1* (*see page 114*).

This parameter can be accessed if [AI3 Type] *R* , *3* *L* is set to [Current] *0* *R*.

### [AI3 Max. value] *C* , *H* *3* ★

AI3 current scaling parameter of 100%.

Identical to [AI1 Max. value] *C* , *H* *1* (*see page 114*).

This parameter can be accessed if [AI3 Type] *R* , *3* *L* is set to [Current] *0* *R*.

### [AI3 filter] *R* , *3* *F*

AI3 cutoff time of the low filter.

Identical to [AI1 filter] *R* , *1* *F* (*see page 114*).

### [AI3 X Interm. point] *R* , *3* *E*

AI3 delinearization input level.

Identical to [AI1 Interm. point X] *R* , *1* *E* (*see page 114*).

### [AI3 Y Interm. point] *R* , *3* *S*

AI3 delinearization output level.

Identical to [AI1 Interm. point Y] *R* , *1* *S* (*see page 114*).

**[AI4 configuration] R , 4 - Menu**

**Access**

[Complete settings] → [Input/Output] → [AI4 configuration]

**[AI4 Assignment] R , 4 R ★**

AI4 functions assignment.

This parameter can be accessed if VW3A3203 I/O extension module has been inserted.

Identical to [AI1 Assignment] R , 1 R (see page 113).

**[AI4 Type] R , 4 E ★**

Configuration of analog input AI4.

This parameter can be accessed if VW3A3203 I/O extension module has been inserted.

Setting	Code / Value	Description
[Voltage]	1 0 u	0-10 Vdc
[Current]	0 R	0-20 mA Factory setting
[Voltage +/-]	n 1 0 u	-10/+10 Vdc

**[AI4 Min value] u , L 4 ★**

AI4 voltage scaling parameter of 0%.

Identical to [AI1 Min value] u , L 1 (see page 113).

**[AI4 Max. value] u , H 4 ★**

AI4 voltage scaling parameter of 100%.

Identical to [AI1 Max. value] u , H 1 (see page 113).

**[AI4 Min. value] C r L 4 ★**

AI4 current scaling parameter of 0%.

Identical to [AI1 Min. value] C r L 1 (see page 114).

**[AI4 Max. value] C r H 4 ★**

AI4 current scaling parameter of 100%.

Identical to [AI1 Max. value] C r H 1 (see page 114).

**[AI4 filter] R , 4 F ★**

AI4 cutoff time of the low filter.

This parameter can be accessed if VW3A3203 I/O extension module has been inserted.

Identical to [AI1 filter] R , 1 F (see page 114).

**[AI4 X Interm. point] R , 4 E ★**

AI4 delinearization input level.

This parameter can be accessed if VW3A3203 I/O extension module has been inserted.

Identical to [AI1 Interm. point X] R , 1 E (see page 114).

**[AI4 Y Interm. point] R , 4 S ★**

AI4 delinearization output level.

This parameter can be accessed if VW3A3203 I/O extension module has been inserted.

Identical to [AI1 Interm. point Y] R , 1 S (see page 114).

**[AI5 configuration] R , 5 - Menu****Access**

[Complete settings] → [Input/Output] → [AI5 configuration]

**[AI5 Assignment] R , 5 R ★**

AI5 functions assignment.

This parameter can be accessed if VW3A3203 I/O extension module has been inserted.

Identical to [AI1 Assignment] R , 1 R (see page 113).

**[AI5 Type] R , 5 E ★**

Configuration of analog input AI5.

This parameter can be accessed if VW3A3203 I/O extension module has been inserted.

Identical to [AI4 Type] R , 4 E . (see page 118)

**[AI5 Min. value] L , L 5 ★**

AI5 voltage scaling parameter of 0%.

Identical to [AI1 Min. value] L , L 1 (see page 113).

**[AI5 Max. value] L , H 5 ★**

AI5 voltage scaling parameter of 100%.

Identical to [AI1 Max. value] L , H 1 (see page 113).

**[AI5 Min. value] C r L 5 ★**

AI5 current scaling parameter of 0%.

Identical to [AI1 Min. value] C r L 1 (see page 114).

**[AI5 Max. value] C r H 5 ★**

AI5 current scaling parameter of 100%.

Identical to [AI1 Max. value] C r H 1 (see page 114).

**[AI5 filter] R , 5 F ★**

AI5 cutoff time of the low filter.

This parameter can be accessed if VW3A3203 I/O extension module has been inserted.

Identical to [AI1 filter] R , 1 F (see page 114).

**[AI5 X Interm. point] R , 5 E ★**

AI5 delinearization input level.

This parameter can be accessed if VW3A3203 I/O extension module has been inserted.

Identical to [AI1 Interm. point X] R , 1 E (see page 114).

**[AI5 Y Interm. point] R , 5 S ★**

AI5 delinearization output level.

This parameter can be accessed if VW3A3203 I/O extension module has been inserted.

Identical to [AI1 Interm. point Y] R , 1 S (see page 114).

**[Virtual AI1] *P V I* - Menu****Access**

[Complete settings] → [Input/Output] → [Virtual AI1]

**[AIV1 Assignment] *P V I R***

Virtual AI1 function assignment.

Setting	Code / Value	Description
[No]	<i>n a</i>	Not assigned
[PID Feedback]	<i>P , F</i>	PI controller feedback
[Inst Flow Assign]	<i>F 5 I R</i>	Select the source of installation flow sensor
[Pump Flow Assign]	<i>F 5 2 R</i>	Select the source of pump flow sensor



## [DQ11 Configuration] *d o l l* - Menu

### Access

[Complete settings] → [Input/Output] → [DQ11 Configuration]

### About This Menu

Following parameters can be accessed if VW3A3203 I/O extension module has been inserted.

### [DQ11 Assignment] *d o l l* ★

Digital output 11 assignment.

Identical to [R2 Assignment] *r 2* (see page 126)

### [DQ11 actv delay] *d l l d* ★

DQ11 activation delay time.

The delay cannot be set for the [Operating State "Fault"] *F L E* and [Mains Contactor] *L L C* assignments, and remains at 0.

The state modification only takes effect once the configured time has elapsed when the information becomes true.

Setting	Description
0...60,000 ms	Setting range 0...9,999 ms then 10.00...60.00 s on the Plain Text Display Terminal <b>Factory setting:</b> 0 ms

### [DQ11 status] *d l l 5* ★

DQ11 status (output active level).

Setting	Code / Value	Description
[1]	<i>P o 5</i>	State 1 when the information is true <b>Factory Setting</b>
[0]	<i>n E G</i>	State 0 when the information is true

The configuration [1] *P o 5* cannot be modified for the following assignments:

- [Operating State "Fault"] *F L E*,
- [Mains Contactor] *L L C*,
- [Priming] *P r i n*,
- [Jockey] *J o k y*,
- [Pump 1 Cmd] *П P o 1*,
- [Pump 2 Cmd] *П P o 2*,
- [Pump 3 Cmd] *П P o 3*,
- [Pump 4 Cmd] *П P o 4*,
- [Pump 5 Cmd] *П P o 5*,
- [Pump 6 Cmd] *П P o 6*,

### [DQ11 hold delay] *d l l H* ★

DQ11 holding delay time.

The holding time cannot be set for the [Operating State "Fault"] *F L E*, and [Mains Contactor] *L L C* assignments, and remains at 0.

The holding time cannot be set and remains at 0 for the following assignments:

- [Operating State "Fault"] *F L E*,
- [Mains Contactor] *L L C*,
- [Priming] *P r i n*,
- [Jockey] *J o k y*,
- [Pump 1 Cmd] *П P o 1*,

- [Pump 2 Cmd] П P o 2,
- [Pump 3 Cmd] П P o 3,
- [Pump 4 Cmd] П P o 4,
- [Pump 5 Cmd] П P o 5,
- [Pump 6 Cmd] П P o 6,

The state modification only takes effect once the configured time has elapsed when the information becomes false.

Setting	Description
0...9,999 ms	Setting range <b>Factory setting:</b> 0 ms

## [DQ12 Configuration] *d o 12* - Menu

### Access

[Complete settings] → [Input/Output] → [DQ12 Configuration]

### About This Menu

Identical to [DQ11 Configuration] *d o 11* - Menu (*see page 121*).

Following parameters can be accessed if VW3A3203 I/O extension module has been inserted.

### [DQ12 Assignment] *d o 12* ★

Digital output 12 assignment.

### [DQ12 actv delay] *d 12 d* ★

DQ12 activation delay time.

### [DQ12 status] *d 12 S* ★

DQ12 status (output active level).

### [DQ12 hold delay] *d 12 H* ★

DQ12 holding delay time.

**[R1 configuration] r / - Menu****Access**

[Complete settings] → [Input/Output] → [R1 configuration]

**[R1 Assignment] r /**

R1 assignment.

Setting	Code / Value	Description
[No]	<i>n a</i>	Not assigned
[Operating State Fault]	<i>F L t</i>	Operating state fault <b>Factory setting</b>
[Drive Running]	<i>r u n</i>	Drive running
[Mot Freq High Thd]	<i>F t R</i>	Motor frequency threshold ([ <b>Motor Freq Thd</b> ] <i>F t d</i> ) reached
[High Speed Reached]	<i>F L R</i>	High speed reached
[Current Thd Reached]	<i>C t R</i>	Motor current threshold ([ <b>High Current Thd</b> ] <i>C t d</i> ) reached
[Ref Freq Reached]	<i>S r R</i>	Frequency reference reached
[Motor Therm Thd Reached]	<i>t S R</i>	Motor thermal threshold ([ <b>Motor Therm Thd</b> ] <i>t t d</i> ) reached
[PID Error Warning]	<i>P E E</i>	PID error warning
[PID Feedback Warning]	<i>P F R</i>	PID feedback warning
[AI2 4-20 Loss Warning]	<i>A P 2</i>	AI2 4-20 mA loss warning
[Mot Freq High Thd 2]	<i>F 2 R</i>	Second frequency threshold ([ <b>Freq. threshold 2</b> ] <i>F 2 d</i> ) reached
[Drv Therm Thd Reached]	<i>t R d</i>	Drive thermal threshold reached
[Ref Freq High Thd Reached]	<i>r t R H</i>	Frequency reference high threshold reached
[Ref Freq Low Thd Reached]	<i>r t R L</i>	Frequency reference low threshold reached
[Mot Freq Low Thd]	<i>F t R L</i>	Frequency low threshold ([ <b>Low Freq. Threshold</b> ] <i>F t d L</i> ) reached
[Motor Freq Low Thd 2]	<i>F 2 R L</i>	Second frequency low threshold ([ <b>2 Freq. Threshold</b> ] <i>F 2 d L</i> ) reached
[Low Current Reached]	<i>C t R L</i>	Current low threshold ([ <b>Low I Threshold</b> ] <i>C t d L</i> ) reached
[Process Undld Warning]	<i>u L R</i>	Underload warning
[Process Overload Warning]	<i>o L R</i>	Overload warning
[PID High Fdbck Warning]	<i>P F R H</i>	PID feedback high threshold (PAH) reached
[PID Low Fdbck Warning]	<i>P F R L</i>	PID feedback low threshold (PAL) reached
[Regulation Warning]	<i>P i S H</i>	PID regulation unable to reach the set point
[Forward]	<i>Π F r d</i>	Run forward
[Reverse]	<i>Π r r 5</i>	Run reverse
[HMI Cmd]	<i>b Π P</i>	Control via the Graphic Display Terminal is active. (only active with Local/Remote button)
[Ramp switching]	<i>r P 2</i>	Ramp switching state
[set 1 active]	<i>C F P 1</i>	Parameter set 1 active
[set 2 active]	<i>C F P 2</i>	Parameter set 2 active
[set 3 active]	<i>C F P 3</i>	Parameter set 3 active
[DC Bus Charged]	<i>d b L</i>	DC bus charged
[I present]	<i>Π C P</i>	Motor current present
[Warning Grp 1]	<i>R G 1</i>	Warning group 1
[Warning Grp 2]	<i>R G 2</i>	Warning group 2
[Warning Grp 3]	<i>R G 3</i>	Warning group 3
[Warning Grp 4]	<i>R G 4</i>	Warning group 4
[Warning Grp 5]	<i>R G 5</i>	Warning group 5
[External Error Warning]	<i>E F R</i>	External error warning
[Undervoltage Warning]	<i>u S R</i>	Undervoltage warning
[Preventive UnderV Active]	<i>u P R</i>	Undervoltage prevention warning
[Drive Thermal Warning]	<i>t H R</i>	Drive thermal state warning

Setting	Code / Value	Description
[IGBT Thermal Warning]	<i>t J R</i>	Thermal junction warning
[AI3 4-20 Loss Warning]	<i>R P 3</i>	AI3 4-20 mA loss warning
[AI4 4-20 Loss Warning]	<i>R P 4</i>	AI4 4-20 mA loss warning
[AI5 4-20 Loss Warning]	<i>R P 5</i>	AI5 4-20 mA loss warning
[Ready]	<i>r d Y</i>	Ready to start
[AI1 4-20 Loss Warning]	<i>R P 1</i>	AI1 4-20 mA loss warning
[Fallback speed]	<i>F r F</i>	Reaction on event / fallback speed
[Speed Maintained]	<i>r L 5</i>	Reaction on event / maintain speed
[Per Type of Stop]	<i>S t t</i>	Reaction on event / stop on STT without an error triggered after stop.
[AI3 Th Warning]	<i>t P 3 R</i>	Thermal 3 warning
[AI4 Th Warning]	<i>t P 4 R</i>	Thermal 4 warning
[AI5 Th Warning]	<i>t P 5 R</i>	Thermal 5 warning
[Pump 1 Cmd]	<i>Π P o 1</i>	Pump 1 command
[Pump 2 Cmd]	<i>Π P o 2</i>	Pump 2 command
[Pump 3 Cmd]	<i>Π P o 3</i>	Pump 3 command
[Pump 4 Cmd]	<i>Π P o 4</i>	Pump 4 command
[Pump 5 Cmd]	<i>Π P o 5</i>	Pump 5 command
[Pump 6 Cmd]	<i>Π P o 6</i>	Pump 6 command
[Temp Sens AI2 Warn]	<i>t S 2 R</i>	Temperature sensor AI2 warning (open circuit)
[Temp Sens AI3 Warn]	<i>t S 3 R</i>	Temperature sensor AI3 warning (open circuit)
[Temp Sens AI4 Warn]	<i>t S 4 R</i>	Temperature sensor AI4 warning (open circuit)
[Temp Sens AI5 Warn]	<i>t S 5 R</i>	Temperature sensor AI5 warning (open circuit)

**[R1 Delay time] *r l d***

R1 activation delay time.

The state modification takes effect once the configured time has elapsed when the information becomes true.

The delay cannot be set for the **[Operating State Fault] *F L t*** assignment; and remains at 0.

Setting	Description
0...60,000 ms	Setting range <b>Factory setting:</b> 0 ms

**[R1 Active at] *r l 5***

R1 status (output active level).

Setting	Code / Value	Description
1	<i>P o 5</i>	State 1 when the information is true <b>Factory setting</b>
0	<i>n E G</i>	State 0 when the information is true

Configuration **[1] *P o 5*** cannot be modified for the **[Operating State "Fault"] *F L t*** assignment.

**[R1 Holding time] *r l H***

R1 holding delay time.

The state modification takes effect once the configured time has elapsed when the information becomes false.

The holding time cannot be set for the **[Operating State "Fault"] *F L t*** assignment, and remains at 0.

Setting	Description
0...9,999 ms	Setting range <b>Factory setting:</b> 0 ms

**[R2 configuration] r 2 - Menu****Access**

[Complete settings] → [Input/Output] → [R2 configuration]

**About This Menu**

Identical to [R1 configuration] r 1 - Menu (*see page 124*).

**[R2 Assignment] r 2**

R2 assignment.

Factory setting: [Drive Running] r u n

Identical to [R1 Assignment] r 1 (*see page 124*) in addition to:

Setting	Code / Value	Description
[No]	n o	Not assigned <b>Factory setting</b>
[Mains Contactor]	L L C	Mains contactor control
[Jockey]	J o c k e y	Jockey
[Priming]	P r i m i n g	Priming

**[R2 Delay time] r 2 d**

R2 activation delay time.

**[R2 Active at] r 2 5**

R2 status (output active level).

**[R2 Holding time] r 2 H**

R2 holding delay time.

## [R3 configuration] r 3 - Menu

### Access

[Complete settings] → [Input/Output] → [R3 configuration]

### About This Menu

Identical to [R1 configuration] r 1 - Menu (*see page 124*).

### [R3 Assignment] r 3

R3 assignment.

Factory setting: [Ready] r d 4

Identical to [R2 Assignment] r 2 (*see page 126*).

### [R3 Delay time] r 3 d

R3 activation delay time.

### [R3 Active at] r 3 5

R3 status (output active level).

### [R3 Holding time] r 3 H

R3 holding delay time.

## [R4 configuration] r 4 - Menu

### Access

[Complete settings] → [Input/Output] → [R4 configuration]

### About This Menu

Identical to [R1 configuration] r 1 - Menu (*see page 124*).

Following parameters can be accessed if VW3A3204 relay output option module has been inserted.

### [R4 Assignment] r 4 ★

R4 assignment.

Identical to [R2 Assignment] r 2 (*see page 126*).

### [R4 Delay time] r 4 d ★

R4 activation delay time.

### [R4 Active at] r 4 5 ★

R4 status (output active level).

### [R4 Holding time] r 4 H ★

R4 holding delay time.

## [R5 configuration] r 5 - Menu

### Access

[Complete settings] → [Input/Output] → [R5 configuration]

### About This Menu

Identical to [R1 configuration] r 1 - Menu (*see page 124*).

Following parameters can be accessed if VW3A3204 relay output option module has been inserted.

### [R5 Assignment] r 5 ★

R5 assignment.

Identical to [R2 Assignment] r 2 (*see page 126*).

### [R5 Delay time] r 5 d ★

R5 activation delay time.

### [R5 Active at] r 5 5 ★

R5 status (output active level).

### [R5 Holding time] r 5 H ★

R5 holding delay time.

## [R6 configuration] r 6 - Menu

### Access

[Complete settings] → [Input/Output] → [R6 configuration]

### About This Menu

Identical to [R1 configuration] r 1 - Menu (*see page 124*).

Following parameters can be accessed if VW3A3204 relay output option module has been inserted.

### [R6 Assignment] r 6 ★

R6 assignment.

Identical to [R2 Assignment] r 2 (*see page 126*).

### [R6 Delay time] r 6 d ★

R6 activation delay time.

### [R6 Active at] r 6 5 ★

R6 status (output active level).

### [R6 Holding time] r 6 H ★

R6 holding delay time.



## [AQ1 configuration] *F 0 I* - Menu

### Access

[Complete settings] → [Input/Output] → [AQ1 configuration]

### Minimum and Maximum Output Values

The minimum output value, in volts, corresponds to the lower limit of the assigned parameter and the maximum value corresponds to its upper limit. The minimum value may be greater than the maximum value.

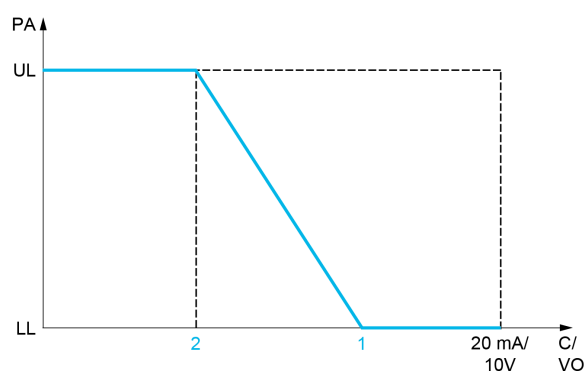
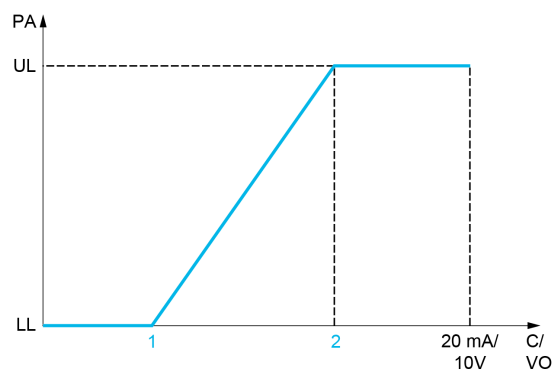

- PA Parameter assigned  
 C / VO Current or voltage output  
 UL Upper limit  
 LL Lower limit  
 1 [Min Output] *F 0 L X* or *u 0 L X*  
 2 [Max Output] *F 0 H X* or *u 0 H X*

### Scaling of the Assigned Parameter

The scale of the assigned parameter can be adapted in accordance with the requirements by modifying the values of the lower and upper limits with two parameters for each analog output.

These parameters are given in %. 100% corresponds to the total variation range of the configured parameter, so: 100% = upper limit - lower limit.

For example, [Sign. torque] *5 L 9* which varies between -3 and +3 times the rated torque, 100% corresponds to 6 times the rated torque.

- The [Scaling AQx min] *F 5 L X* parameter modifies the lower limit: new value = lower limit + (range x *F 5 L X*). The value 0% (factory setting) does not modify the lower limit.
- The [Scaling AQx max] *F 5 H X* parameter modifies the upper limit: new value = lower limit + (range x *F 5 L X*). The value 100% (factory setting) does not modify the upper limit.
- [Scaling AQx min] *F 5 L X* must always be lower than [Scaling AQx max] *F 5 H X*.

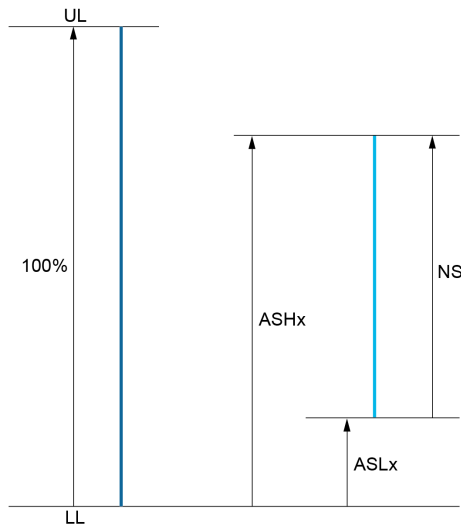

- UL Upper limit of the assigned parameter
- LL Lower limit of the assigned parameter
- NS New scale
- 1 *ASHX*
- 2 *ASLX*

**Application Example**

The value of the motor current at the AQ1 output is to be transferred with 0...20 mA, range 2 in motor, In motor being the equivalent of a 0.8 In drive.

- The **[Motor Current] oCr** parameter varies from 0 to 2 times the rated drive current.
- **[Scaling AQ1 min] HSL** must not modify the lower limit, which therefore remains at its factory setting of 0%.
- **[Scaling AQ1 max] HSH** must modify the upper limit by 0.5x the rated motor torque, or 100 - 100/5 = 80% (new value = lower limit + (range x **[Scaling AQ1 max] HSH**)).

**[AQ1 Assignment] HoI**

AQ1 assignment.

Setting	Code / Value	Description
<b>[Not Configured]</b>	<i>no</i>	Not assigned
<b>[Motor Current]</b>	<i>oCr</i>	Current in the motor, from 0 to 2 In (In = rated drive current indicated in the Installation manual and on the drive nameplate)
<b>[Motor Frequency]</b>	<i>oFr</i>	Output frequency, from 0 to <b>[Max Frequency] tFr</b> <b>Factory Setting</b>
<b>[Ramp out.]</b>	<i>orP</i>	From 0 to <b>[Max Frequency] tFr</b>
<b>[Motor torq.]</b>	<i>trq</i>	Motor torque, from 0 to 3 times the rated motor torque
<b>[Sign. torque]</b>	<i>stq</i>	Signed motor torque, between -3 and +3 times the rated motor torque. The + sign corresponds to the motor mode and the - sign to the generator mode (braking).
<b>[sign ramp]</b>	<i>orS</i>	Signed ramp output, between - <b>[Max Frequency] tFr</b> and + <b>[Max Frequency] tFr</b>
<b>[PID ref.]</b>	<i>oPS</i>	PID controller reference between <b>[Min PID reference] P, P1</b> and <b>[Max PID reference] P, P2</b>
<b>[PID feebk]</b>	<i>oPF</i>	PID controller feedback between <b>[Min PID feedback] P, F1</b> and <b>[Max PID feedback] P, F2</b>
<b>[PID error]</b>	<i>oPE</i>	PID controller detected error between -5% and +5% of <b>[Max PID feedback] P, F2</b> - <b>[Min PID feedback] P, F1</b>
<b>[PID output]</b>	<i>oPi</i>	PID controller output between <b>[Low speed] LSP</b> and <b>[High speed] HSP</b>
<b>[Motor power]</b>	<i>oPr</i>	Motor power, between 0 and 2.5 times <b>[Nominal Motor Power] nPr</b>
<b>[Mot thermal]</b>	<i>thr</i>	Motor thermal state, from 0 to 200% of the rated thermal state

Setting	Code / Value	Description
[Drv thermal]	$t H d$	Drive thermal state, from 0 to 200% of the rated thermal state
[Sig. o/p frq.]	$\alpha F 5$	Signed output frequency, between $-[\text{Max Frequency}] t F r$ and $+\text{[Max Frequency]} t F r$
[Motor volt.]	$\mu \alpha P$	Voltage applied to the motor, between 0 and <b>[Nom Motor Voltage] <math>\mu n 5</math></b>
[Inlet Pressure Value]	$P 5 1 \mu$	Inlet pressure value
[Outlet Pressure Value]	$P 5 2 \mu$	Outlet pressure value
[Installation Flow]	$F 5 1 \mu$	Installation flow value

**[AQ1 Type]  $R \alpha I t$** 

AQ1 type.

Setting	Code / Value	Description
[Voltage]	$I 0 \mu$	0-10 Vdc
[Current]	$0 R$	0-20 mA <b>Factory setting</b>

**[AQ1 min output]  $R \alpha L I \star$** 

AQ1 current scaling parameter of 0%.

This parameter can be accessed if **[AQ1 Type]  $R \alpha I t$**  is set to **[Current]  $0 R$** .

Setting	Description
0.0...20.0 mA	Setting range <b>Factory setting:</b> 4.0 mA

**[AQ1 max output]  $R \alpha H I \star$** 

AQ1 current scaling parameter of 100%.

This parameter can be accessed if **[AQ1 Type]  $R \alpha I t$**  is set to **[Current]  $0 R$** .

Setting	Description
0.0...20.0 mA	Setting range <b>Factory setting:</b> 20.0 mA

**[AQ1 min Output]  $\mu \alpha L I \star$** 

AQ1 voltage scaling parameter of 0%.

This parameter can be accessed if **[AQ1 Type]  $R \alpha I t$**  is set to **[Voltage]  $I 0 \mu$** .

Setting	Description
0.0...10.0 Vdc	Setting range <b>Factory setting:</b> 0.0 Vdc

**[AQ1 max Output]  $\mu \alpha H I \star$** 

AQ1 voltage scaling parameter of 100%.

This parameter can be accessed if **[AQ1 Type]  $R \alpha I t$**  is set to **[Voltage]  $I 0 \mu$** .

Setting	Description
0.0...10.0 Vdc	Setting range <b>Factory setting:</b> 10.0 Vdc

**[Scaling AQ1 min]  $R 5 L I$** 

AQ1 scaling parameter of 0%.

Scaling of the lower limit of the assigned parameter, as a % of the maximum possible variation.

Setting	Description
0.0...100.0%	Setting range <b>Factory setting:</b> 0.0%

### [Scaling AQ1 max] *FSHI*

AQ1 scaling parameter of 100%.

Scaling of the upper limit of the assigned parameter, as a % of the maximum possible variation.

Setting	Description
0.0...100.0%	Setting range <b>Factory setting:</b> 100.0%

### [AQ1 Filter] *FI*

AQ1 cutoff time of the low-filter.

Setting	Description
0.00...10.00 s	Setting range <b>Factory setting:</b> 0.00 s

## [AQ2 configuration] $R \square \square$ - Menu

### Access

[Complete settings] → [Input/Output] → [AQ2 configuration]

### [AQ2 assignment] $R \square \square$

AQ2 assignment.

Possible assignments: Identical to [AQ1 assignment]  $R \square \square$

### [AQ2 Type] $R \square \square \square$

AQ2 type.

Setting	Code / Value	Description
[Voltage]	$1 \square \square$	0-10 Vdc
[Current]	$\square \square$	0-20 mA Factory setting

### [AQ2 min output] $R \square \square \square \star$

AQ2 current scaling parameter of 0%.

This parameter can be accessed if [AQ2 Type]  $R \square \square \square$  is set to [Current]  $\square \square$ .

Identical to [AQ1 min output]  $R \square \square \square$  (see page 131).

### [AQ2 max output] $R \square \square \square \star$

AQ2 current scaling parameter of 100%.

This parameter can be accessed if [AQ2 Type]  $R \square \square \square$  is set to [Current]  $\square \square$ .

Identical to [AQ1 max output]  $R \square \square \square$  (see page 131).

### [AQ2 min Output] $\square \square \square \square \star$

AQ2 voltage scaling parameter of 0%.

This parameter can be accessed if [AQ2 Type]  $R \square \square \square$  is set to [Voltage]  $1 \square \square$ .

Identical to [AQ1 min Output]  $\square \square \square \square$  (see page 131).

### [AQ2 max Output] $\square \square \square \square \star$

AQ2 voltage scaling parameter of 100%.

This parameter can be accessed if [AQ2 Type]  $R \square \square \square$  is set to [Voltage]  $1 \square \square$ .

Identical to [AQ1 max Output]  $\square \square \square \square$  (see page 131).

### [Scaling AQ2 min] $R \square \square \square$

AQ2 scaling parameter of 0%.

Identical to [Scaling AQ1 min]  $R \square \square \square$  (see page 131).

### [Scaling AQ2 max] $R \square \square \square$

AQ2 scaling parameter of 100%.

Identical to [Scaling AQ1 max]  $R \square \square \square$  (see page 132).

### [AQ2 Filter] $R \square \square \square F$

AQ2 cutoff time of the low-filter.

Identical to [AQ1 Filter]  $R \square \square \square F$  (see page 132).

## Section 6.3

### [Command and Reference] C r P - Menu

#### [Command and Reference] C r P - Menu

##### Access

[Complete settings] → [Command and Reference]

##### Command and Reference Channels Parameter Can Be Accessed

Run commands (forward, reverse, stop, and so on) and references can be sent using the following channels:

Command	Reference
Terminals: Digital inputs DI	Terminals: Analog inputs AI, pulse input
Plain Text Display Terminal	Plain Text Display Terminal
Integrated Modbus	Integrated Modbus
Fieldbus module	Fieldbus module
-	+/- speed via the Plain Text Display Terminal

**NOTE:** The stop keys on the Plain Text Display Terminal can be programmed as non-priority keys. A stop key can only have priority if the **[Stop Key Enable] P 5 E** parameter menu is set to **[Stop Key Priority] 4 E 5**.

The behavior of the drive can be adapted according to requirements:

- **[Not separ.] 5 , 7:** Command and reference are sent via the same channel.
- **[Separate] 5 E P:** Command and reference may be sent via different channels. In these configurations, control via the communication bus is performed in accordance with the DRIVECOM standard with only 5 freely assignable bits (see communication parameter manual). The application functions cannot be accessed via the communication interface.
- **[I/O profile] , 0:** The command and the reference can come from different channels. This configuration both simplify and extends use via the communication interface. Commands may be sent via the digital inputs on the terminals or via the communication bus. When commands are sent via a bus, they are available on a word, which acts as virtual terminals containing only digital inputs. Application functions can be assigned to the bits in this word. More than one function can be assigned to the same bit.

**NOTE:** Stop commands from the Plain Text Display Terminal remain active even if the terminals are not the active command channel.

Reference Channel for [Not separ.] 5, 7, [Separate] 5EP and [I/O profile] 10 Configurations, PID Not Configured

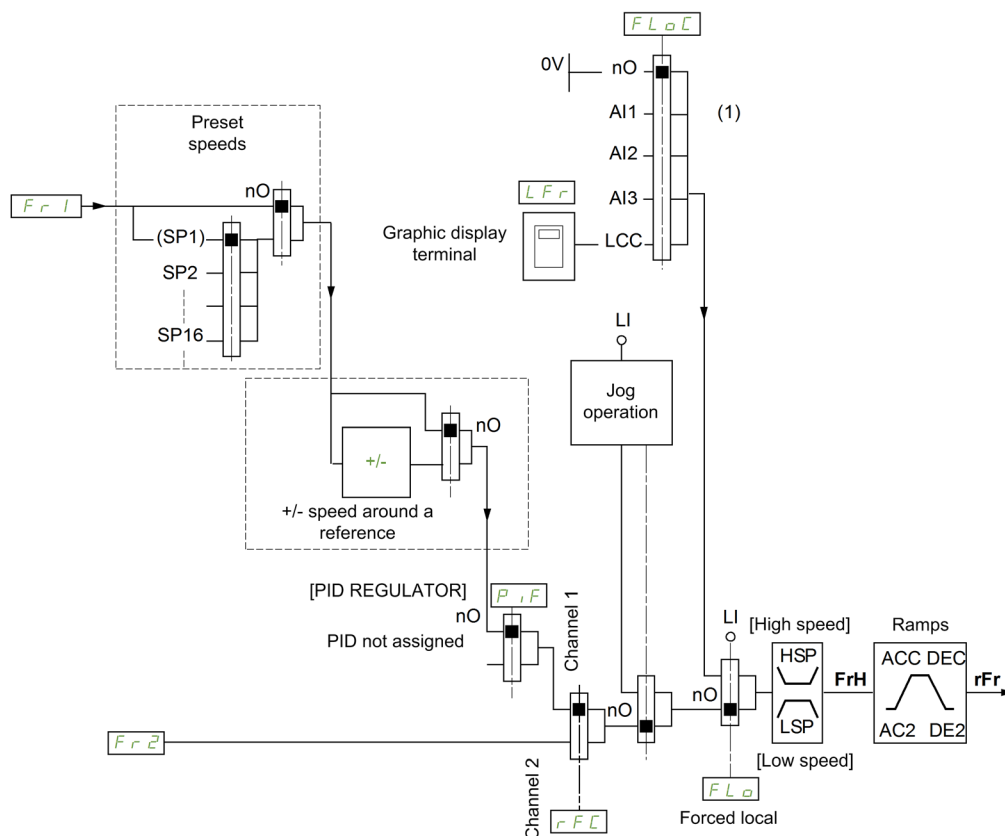

(1) Note: Forced local is not active in [I/O].

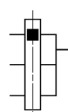

The black square represents the factory setting assignment.

$Fr1$ : terminals (including I/O extension module), Plain Text Display Terminal, integrated Modbus, and fieldbus module.

$Fr2$ : terminals (including I/O extension module), Plain Text Display Terminal, integrated Modbus, +/- speed, and fieldbus module.

Reference Channel for [Not separ.] 5 , 7, [Separate] 5 EP and [I/O profile] , 8 Configurations, PID Configured with PID References at the Terminals

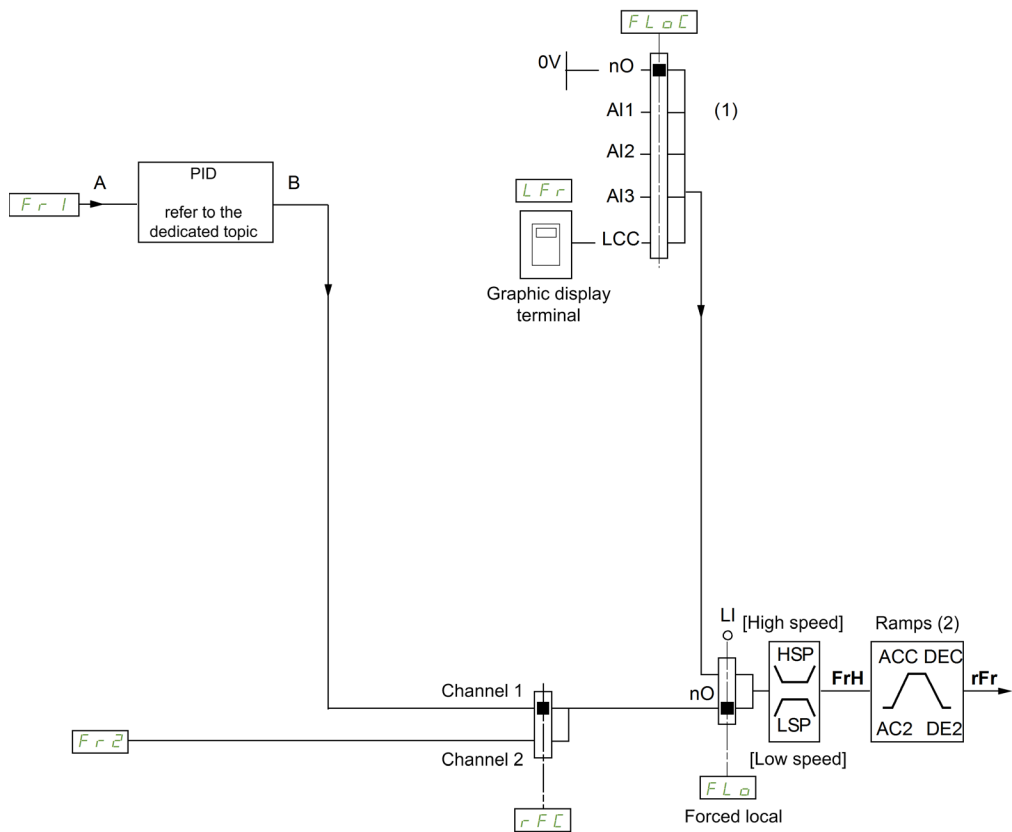

- (1) **Note:** Forced local is not active in [I/O profile].
- (2) Ramps not active if the PID function is active in automatic mode.

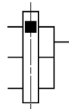

The black square represents the factory setting assignment.

*Fr1*: terminals (including I/O extension module), Plain Text Display Terminal, integrated Modbus, and fieldbus module.

*Fr2*: terminals (including I/O extension module), Plain Text Display Terminal, integrated Modbus, +/- speed, and fieldbus module.

Command Channel for [Not separ.] 5 , 7 configuration

Reference and command, not separate.

The command channel is determined by the reference channel. The parameters *Fr1*, *Fr2*, *FrE*, *FLD* and *FLCE* are common to reference and command.

Example: If the reference is *Fr1* = *A*, *I* (analog input at the terminals), control is via DI (digital input at the terminals).



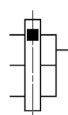
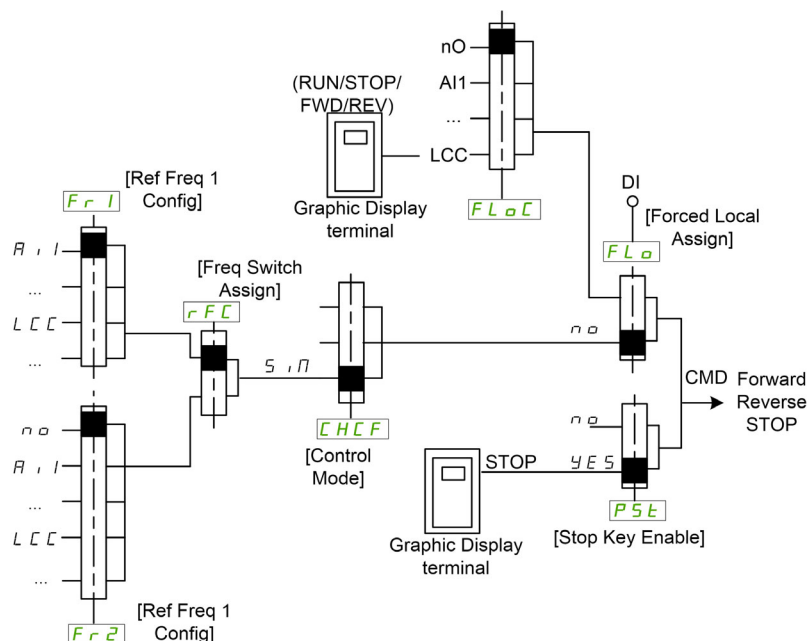

The black square represents the factory setting assignment.

### Command Channel for [Separate] SEP configuration

Separated Reference and command.

The parameters *FLo* and *FLoC* are common to reference and command.

Example: If the reference is in forced local mode via AI1 (analog input at the terminals), command in forced local mode is via DI (digital input at the terminals).

The command channels *Cd1* and *Cd2* are independent of the reference channels *Fr1* and *Fr2*.

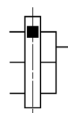
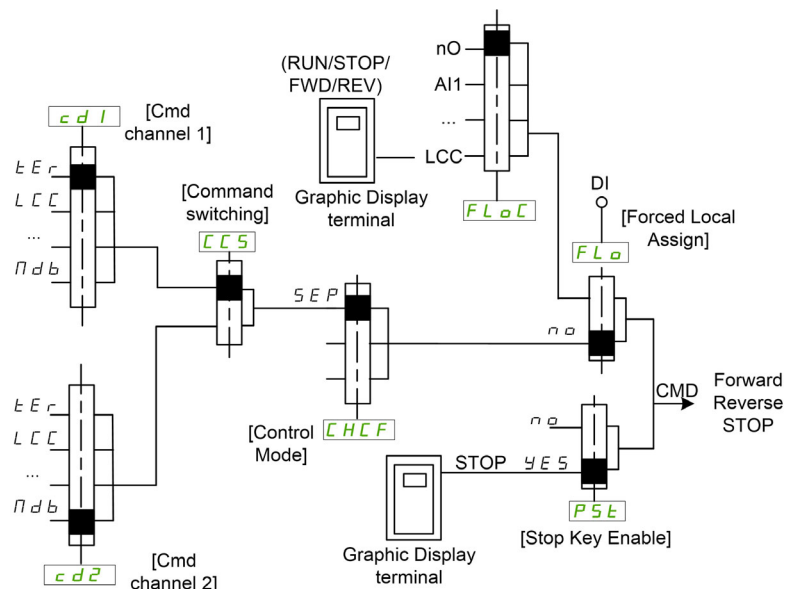

The black square represents the factory setting assignment, except for [Control Mode] *CHCF*.

[Cmd channel 1] *Cd1* and [Cmd channel 2] *Cd2*: Terminals, Plain Text Display Terminal, fieldbus module

**Command Channel for I/O profile *io* configuration**

Separated Reference and command, as in **[Separate] 5EP** configuration.

The command channels *Cd1* and *Cd2* are independent of the reference channels *Fr1* and *FR2*.

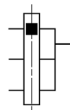
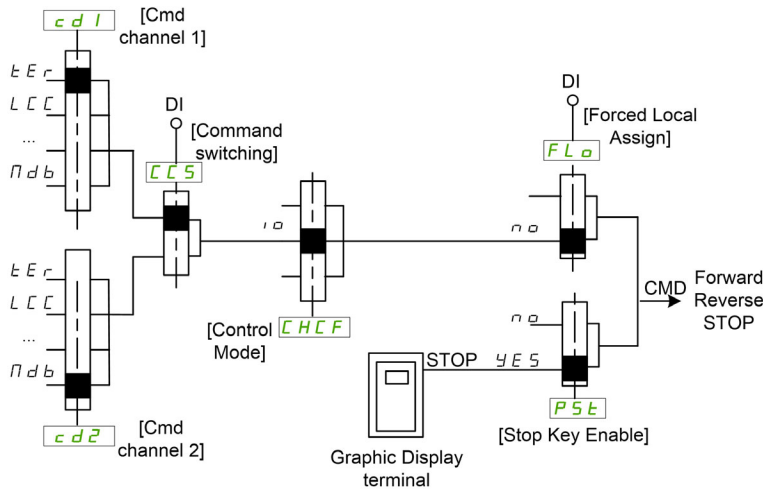

The black square represents the factory setting assignment, except for **[Control Mode] CHCF**.

**[Cmd channel 1] Cd1** and **[Cmd channel 2] Cd2**: Terminals, Plain Text Display Terminal, fieldbus module

A command or an action can be assigned:

- To a fixed channel by selecting a Digital input (Dix) or a Cxxx bit:
  - By selecting, for example, LI3, this action will be triggered by the digital input DI3 regardless of which command channel is switched.
  - By selecting, for example, C114, this action will be triggered by integrated Modbus with bit 14 regardless of which command channel is switched.
- To a switchable channel by selecting a CDxx bit:
  - By selecting, for example, Cd11, this action will be triggered by: LI12 if the terminals channel is active, C111 if the integrated Modbus channel is active, C311 if the communication card channel is active.

If the active channel is the graphic display terminal, the functions and commands assigned to CDxx switchable internal bits are inactive.

**NOTE:** Several CDxx does not have equivalent digital inputs and can only be used for switching between 2 networks.

**[Low Speed] L5P**

Motor frequency at low speed.

Setting ( )	Description
0...500 Hz	Setting range <b>Factory setting:</b> 0 Hz

**[High Speed] H5P**

Motor frequency at high speed.

It is recommended to have **[Max Frequency] EFr** equal to or higher than 110% of **[High Speed] H5P**.

Setting ( )	Description
0...500 Hz	Setting range <b>Factory setting:</b> 500 Hz

**[Ref Freq 1 Config] F r 1**

Configuration reference frequency 1.

Setting	Code / Value	Description
[Not Configured]	n o	Not assigned
[AI1]	A , 1	Analog input AI1 <b>Factory Setting</b>
[AI2]...[AI3]	A , 2...A , 3	Analog input AI2...AI3
[AI Virtual 1]	A , V 1	Virtual analogic input 1
[AI4]...[AI5]	A , 4...A , 5	Analog input AI4...AI5 if VW3A3203 I/O extension module has been inserted
[Ref.Freq-Rmt.Term]	L C C	Reference Frequency via remote terminal
[Ref. Freq-Modbus]	M o d b	Reference frequency via Modbus
[Ref. Freq-Com. Module]	n E t	Reference frequency via fieldbus module if a fieldbus module has been inserted
[DI5 PulseInput Assignment]...[DI6 PulseInput Assignment]	P , 5...P , 6	Digital input DI5...DI6 used as pulse input

**[Reverse Disable] r i n**

Reverse directions disable.

Lock of movement in reverse direction does not apply to direction requests sent by digital inputs.

Reverse direction requests sent by digital inputs are taken into account.

Reverse direction requests sent by the Plain Text Display Terminal or sent by the line are not taken into account.

Any reverse speed reference originating from the PID, and so on, is interpreted as a zero reference (0 Hz).

Setting	Code / Value	Description
[No]	n o	No
[Yes]	Y E S	Yes <b>Factory Setting</b>

**[Stop Key Enable] P 5 t**

Stop key enable.

Setting this function to n o disables the STOP key of the Display Terminal if the setting of the parameter [Command Channel] C P d C is not [Ref. Freq-Rmt.Term] L C C .

## ⚠ WARNING

### LOSS OF CONTROL

Only set this parameter to n o if you have implemented appropriate alternative stop functions.

**Failure to follow these instructions can result in death, serious injury, or equipment damage.**

Irrespective of the configuration of [Stop Key Enable] P 5 t , if the active command channel is the Plain Text Display Terminal, the STOP/RESET key performs:

- in run, a stop according to the [Type of stop] 5 t t ,
- in "Operating State Fault", a fault reset command.

The following table gives the behavior of the function when the Plain Text Display Terminal is not the active command channel:

Setting	Code / Value	Description
[Stop Key No Priority]	n o	Disables the STOP/RESET key on the Plain Text Display Terminal.
[Stop Key Priority]	Y E S	Gives priority to the STOP key on the Plain Text Display Terminal. Only the stop function is enabled. The stop is performed in freewheel. <b>Factory Setting</b>

[Control Mode] *C H C F* 

Mixed mode configuration.

<b> WARNING</b>
<b>UNANTICIPATED EQUIPMENT OPERATION</b>
Disabling <b>[I/O profile]</b> <i>i o</i> resets the drive to the factory settings.
<ul style="list-style-type: none"> <li>• Verify that restoring the factory settings is compatible with the type of wiring used.</li> </ul>
<b>Failure to follow these instructions can result in death, serious injury, or equipment damage.</b>

Setting	Code / Value	Description
[Not separ.]	<i>S i n</i>	Reference and command, not separate <b>Factory Setting</b>
[Separate]	<i>S E P</i>	Separate reference and command. This assignment cannot be accessed in <b>[I/O profile]</b> <i>i o</i>
[I/O profile]	<i>i o</i>	I/O profile

[Command Switching] *C C S* 

<b> WARNING</b>
<b>UNANTICIPATED EQUIPMENT OPERATION</b>
This parameter can cause unintended movements, for example an inversion of the direction of the rotation of the motor, a sudden acceleration or a stop.
<ul style="list-style-type: none"> <li>• Verify that the setting of this parameter does not cause unintended movements.</li> <li>• Verify that the setting of this parameter does not result in unsafe conditions.</li> </ul>
<b>Failure to follow these instructions can result in death, serious injury, or equipment damage.</b>

Control channel switch.

This parameter can be accessed if **[Control Mode]** *C H C F* is set to **[Separate]** *S E P* or to **[I/O profile]** *i o*.

If the assigned input or bit is at 0, channel **[Cmd channel 1]** *C d 1* is active. If the assigned input or bit is at 1, channel **[Cmd channel 2]** *C d 2* is active.

**NOTE:** Activating this function from an other active command channel will also activate the monitoring of this new channel.

Setting	Code / Value	Description
<b>[Command channel 1]</b>	<i>C d 1</i>	Command channel = channel 1 (for CCS) <b>Factory setting</b>
<b>[Command channel 2]</b>	<i>C d 2</i>	Command channel = channel 2 (for CCS)
<b>[DI1]...[DI6]</b>	<i>L i l...L i 6</i>	Digital input DI1...DI6
<b>[DI11]...[DI16]</b>	<i>L i i l...L i 16</i>	Digital input DI11...DI16 if VW3A3203 I/O extension module has been inserted
<b>[C101]...[C110]</b>	<i>C i 0 i...C i 10</i>	Virtual digital input CMD1.01...CMD1.10 with integrated Modbus Serial in <b>[I/O profile]</b> <i>i o</i> configuration
<b>[C111]...[C115]</b>	<i>C i i i...C i 15</i>	Virtual digital input CMD1.11...CMD1.15 with integrated Modbus Serial regardless of configuration
<b>[C301]...[C310]</b>	<i>C 3 0 i...C 3 10</i>	Virtual digital input CMD3.01...CMD3.10 with a fieldbus module in <b>[I/O profile]</b> <i>i o</i> configuration
<b>[C311]...[C315]</b>	<i>C 3 i i...C 3 15</i>	Virtual digital input CMD3.11...CMD3.15 with a fieldbus module regardless of configuration

**[Cmd channel 1] C d 1** ★

Command channel 1 assignment.

This parameter can be accessed if [Control Mode] C H C F is set to [Separate] S E P or [I/O profile] , 0 .

Setting	Code / Value	Description
[Terminals]	t E r	Terminal block source <b>Factory Setting</b>
[Ref.Freq-Rmt.Term]	L C C	Command via Plain Text Display Terminal
[Ref. Freq-Modbus]	n d b	Command via Modbus
[Ref. Freq-Com. Module]	n E t	Command via fieldbus module if a fieldbus module has been inserted

**[Cmd channel 2] C d 2** ★

Command channel 2 assignment.

This parameter can be accessed if [Control Mode] C H C F is set to [Separate] S E P or [I/O profile] , 0 .

Identical to [Cmd channel 1] C d 1 with factory setting [Ref. Freq-Modbus] n d b .

**[Freq Switch Assign] r F C****⚠ WARNING****UNANTICIPATED EQUIPMENT OPERATION**

This parameter can cause unintended movements, for example an inversion of the direction of the rotation of the motor, a sudden acceleration or a stop.

- Verify that the setting of this parameter does not cause unintended movements.
- Verify that the setting of this parameter does not result in unsafe conditions.

**Failure to follow these instructions can result in death, serious injury, or equipment damage.**

frequency switching assignment.

If the assigned input or bit is at 0, channel [Ref Freq Channel 1] F r 1 is active.

If the assigned input or bit is at 1, channel [Ref Freq Channel 2] F r 2 is active.

**NOTE:** Activating this function from an other active command channel will also activate the monitoring of this new channel.

Setting	Code / Value	Description
[Ref Freq Channel 1]	F r 1	Reference channel = channel 1 (for RFC)
[Ref Freq Channel 2]	F r 2	Reference channel = channel 2 (for RFC)
[DI1]...[DI6]	L , 1...L , 6	Digital input DI1...DI6
[DI11]...[DI16]	L , 11...L , 16	Digital input DI11...DI16 if VW3A3203 I/O extension module has been inserted
[CD00]...[CD10]	C d 0 0...C d 1 0	Virtual digital input CMD.0...CMD.10 in [I/O profile] , 0 configuration
[CD11]...[CD15]	C d 1 1...C d 1 5	Virtual digital input CMD.11...CMD.15 regardless of configuration
[C101]...[C110]	C 1 0 1...C 1 1 0	Virtual digital input CMD1.01...CMD1.10 with integrated Modbus Serial in [I/O profile] , 0 configuration
[C111]...[C115]	C 1 1 1...C 1 1 5	Virtual digital input CMD1.11...CMD1.15 with integrated Modbus Serial regardless of configuration
[C301]...[C310]	C 3 0 1...C 3 1 0	Virtual digital input CMD3.01...CMD3.10 with a fieldbus module in [I/O profile] , 0 configuration
[C311]...[C315]	C 3 1 1...C 3 1 5	Virtual digital input CMD3.11...CMD3.15 with a fieldbus module regardless of configuration

[Ref Freq 2 Config] *F r 2*

Configuration reference frequency 2.

Setting	Code / Value	Description
[Not Configured]	<i>n o</i>	Not assigned. If [Control Mode] <i>C H C F</i> is set to [Not separ.] <i>5 , 11</i> , the command is at the terminals with a zero reference. If [Control Mode] <i>C H C F</i> is set to [Separate] <i>5 E P</i> or [I/O profile] <i>1 o</i> , the reference is zero. <b>Factory Setting</b>
[AI1]...[AI3]	<i>R , 1...R , 3</i>	Analog input AI1...AI3
[AI4]...[AI5]	<i>R , 4...R , 5</i>	Analog input AI4...AI5 if VW3A3203 I/O extension module has been inserted
[Ref Frequency via DI]	<i>u P d t</i>	+/- speed command assigned to DIx
[Ref.Freq-Rmt.Term]	<i>L C C</i>	Reference frequency via Graphic Display Terminal
[Ref. Freq-Modbus]	<i>11 d b</i>	Reference frequency via Modbus
[Ref. Freq-Com. Module]	<i>n E t</i>	Reference frequency via fieldbus module if a fieldbus module has been inserted
[PulseInput Assignment On DI5]...[PulseInput Assignment On DI6]	<i>P , 5...P , 6</i>	Digital input DI5...DI6 used as pulse input

[Copy Ch1-Ch2] *C o P* 

Copy channel 1 reference frequency to channel 2.

** WARNING**

**UNANTICIPATED EQUIPMENT OPERATION**

This parameter can cause unintended movements, for example an inversion of the direction of the rotation of the motor, a sudden acceleration or a stop.

- Verify that the setting of this parameter does not cause unintended movements.
- Verify that the setting of this parameter does not result in unsafe conditions.

**Failure to follow these instructions can result in death, serious injury, or equipment damage.**

Can be used to copy the current reference and/or the command with switching in order to avoid speed surges, for example.

If [Control Mode] *C H C F* (see page 140) is set to [Not separ.] *5 , 11* or [Separate] *5 E P*, copying is possible only from channel 1 to channel 2.

If [Control Mode] *C H C F* is set to [I/O profile] *1 o*, copying is possible in both directions. A reference or a command cannot be copied to a channel on the terminals. The reference copied is [Pre-Ramp Ref Freq] *F r H* (before ramp) unless the destination channel reference is set via +/- speed. In this case, the reference copied is [Output frequency] *r F r* (after ramp).

Setting	Code / Value	Description
[No]	<i>n o</i>	No copy <b>Factory Setting</b>
[Reference Frequency]	<i>5 P</i>	Copy reference
[Command]	<i>C d</i>	Copy command
[Cmd + Ref Frequency]	<i>R L L</i>	Copy reference and command

As the Plain Text Display Terminal may be selected as the command and/or reference channel, its action modes can be configured.

Comments:

- The Plain Text Display Terminal command/reference is only active if the command and/or reference channels from the terminal are active except for **BMP** with Local/ Remote key (command via the Plain Text Display Terminal), which takes priority over these channels. Press Local/ Remote key again to revert control to the selected channel.
- Command and reference via the Plain Text Display Terminal are impossible if the latter is connected to more than one drive.
- The preset PID reference functions can only be accessed if **[Control Mode] C H C F** is set to **[Not separ.] S , Π** or **[Separate] S E P**.
- The command via the Plain Text Display Terminal can be accessed regardless of the **[Control Mode] C H C F**.

### [Forced Local Freq] *F L o C*

Forced local reference source assignment.

Setting	Code / Value	Description
[Not Configured]	<i>n o</i>	Not assigned (control via the terminals with zero reference) <b>Factory Setting</b>
[AI1]...[AI3]	<i>A , 1...A , 3</i>	Analog input AI1...AI3
[AI4]...[AI5]	<i>A , 4...A , 5</i>	Analog input AI4...AI5 if VW3A3203 I/O extension module has been inserted
[Ref.Freq-Rmt.Term]	<i>L C C</i>	Graphic Display Terminal
[PulseInput Assignment On DI5]...[PulseInput Assignment On DI6]	<i>P , 5...P , 6</i>	Digital input DI5...DI6 used as pulse input

### [Time-out Forc. Local] *F L o t* ★

Time for channel confirmation after forced local.

This parameter can be accessed if **[Forced Local Assign] F L o** is not set to **[No] n o**.

Setting (↺)	Description
0.1...30.0 s	Setting range <b>Factory setting:</b> 10.0 s

### [Forced Local Assign] *F L o*

Forced local assignment.

Forced local mode is active when the input is at state 1.

**[Forced Local Assign] F L o** is forced to **[No] n o** if **[Control Mode] C H C F** is set to **[I/O profile] i o**.

Setting	Code / Value	Description
[Not Assigned]	<i>n o</i>	Not assigned <b>Factory setting</b>
[DI1]...[DI6]	<i>L , 1...L , 6</i>	Digital input DI1...DI6
[DI11]...[DI16]	<i>L , 11...L , 16</i>	Digital input DI11...DI16 if VW3A3203 I/O extension module has been inserted

**[HMI cmd.] bPP**

HMI command.

Setting	Code / Value	Description
[Stop]	<i>StoP</i>	Stops the drive (although the controlled direction of operation and reference of the previous channel are copied (to be taken into account on the next RUN command))
[Bumpless]	<i>b u P P</i>	Does not stop the drive (the controlled direction of operation and the reference of the previous channel are copied)
[Disabled]	<i>d , 5</i>	Disabled <b>Factory Setting</b>



## Section 6.4

### [Generic functions] - [Ramp]

#### [Ramp] *rAMP* - Menu

##### Access

[Complete settings] → [Generic functions] → [Ramp]

#### [Ramp Type] *rPt*

Type of ramp.

Setting	Code / Value	Description
[Linear]	<i>L i n</i>	Linear ramp <b>Factory setting</b>
[S-Ramp]	<i>S</i>	S ramp
[U-Ramp]	<i>u</i>	U ramp
[Customized]	<i>C u S</i>	Customer ramp

#### [Ramp increment] *i n c*

This parameter is valid for [Acceleration] *ACC*, [Deceleration] *dEC*, [Acceleration 2] *ACC2* and [Deceleration 2] *dE2*.

This table presents the parameter settings:

Setting ( )	Code / Value	Description
[0.01]	<i>0.01</i>	Ramp up to 99.99 seconds
[0.1]	<i>0.1</i>	Ramp up to 999.9 seconds <b>Factory setting</b>
[1]	<i>1</i>	Ramp up to 6,000 seconds

#### [Acceleration] *ACC*

Time to accelerate from 0 to the [Nominal Motor Freq] *F r 5*.

To have repeatability in ramps, the value of this parameter must be set according to the possibility of the application.

Setting ( )	Description
0.00...6,000.00 s <sup>(1)</sup>	Setting range <b>Factory setting:</b> 30.0 s
<b>(1)</b> Range 0.01 to 99.99 s or 0.1 to 999.9 s or 1 to 6,000 according to [Ramp increment] <i>i n c</i>	

#### [Deceleration] *dEC*

Time to decelerate from the [Nominal Motor Freq] *F r 5* to 0.

To have repeatability in ramps, the value of this parameter must be set according to the possibility of the application.

Setting ( )	Description
0.00...6,000.00 s <sup>(1)</sup>	Setting range <b>Factory setting:</b> 30.0 s
<b>(1)</b> Range 0.01 to 99.99 s or 0.1 to 999.9 s or 1 to 6,000 according to [Ramp increment] <i>i n c</i>	

**[Begin Acc round]  $\epsilon R 1$  ★**

Rounding of start of acceleration ramp as a % of the **[Acceleration]  $R C C$**  or **[Acceleration 2]  $R C 2$**  ramp time.

Can be set from 0 to 100%.

This parameter can be accessed if the **[Ramp type]  $r P E$**  is set to **[Customized]  $C U 5$** .

Setting ( )	Description
0...100%	Setting range <b>Factory setting:</b> 10%

**[End Acc round]  $\epsilon R 2$  ★**

Rounding of end of acceleration ramp as a % of the **[Acceleration]  $R C C$**  or **[Acceleration 2]  $R C 2$**  ramp time.

Can be set between 0 and (100% - **[Begin Acc round]  $\epsilon R 1$** ).

This parameter can be accessed if the **[Ramp type]  $r P E$**  is set to **[Customized]  $C U 5$** .

Setting ( )	Description
0...100%	Setting range <b>Factory setting:</b> 10%

**[Begin Dec round]  $\epsilon R 3$  ★**

Rounding of start of deceleration ramp as a % of the **[Deceleration]  $d E C$**  or **[Deceleration 2]  $d E 2$**  ramp time.

Can be set from 0 to 100%.

This parameter can be accessed if the **[Ramp type]  $r P E$**  is set to **[Customized]  $C U 5$** .

Setting ( )	Description
0...100%	Setting range <b>Factory setting:</b> 10%

**[End Dec round]  $\epsilon R 4$  ★**

Rounding of end of deceleration ramp as a % of the **[Deceleration]  $d E C$**  or **[Deceleration 2]  $d E 2$**  ramp time.

Can be set between 0 and (100% - **[Begin Dec round]  $\epsilon R 3$** ).

This parameter can be accessed if the **[Ramp type]  $r P E$**  is **[Customized]  $C U 5$** .

Setting ( )	Description
0...100%	Setting range <b>Factory setting:</b> 10%

**[SwitchRamp2] Frt**

Ramp switching threshold

The second ramp is switched if the value of **[SwitchRamp2] Frt** is not 0 (0 deactivates the function) and the output frequency is greater than **[SwitchRamp2] Frt**.

Threshold ramp switching can be combined with **[Ramp switch Assign] r P 5** switching as follows:

DI or Bit	Frequency	Ramp
0	< Frt	ACC, dEC
0	> Frt	ACC, dE2
1	< Frt	ACC, dE2
1	> Frt	ACC, dE2

Setting ( )	Description
0.0...500.0 Hz	Setting range Factory setting: 0.0 Hz

**[Ramp switch Assign] r P 5**

Ramp switching.

Setting	Code / Value	Description
<b>[Not Assigned]</b>	<i>n a</i>	Not assigned Factory setting
<b>[DI1]...[DI6]</b>	<i>L , I...L , 6</i>	Digital input DI1...DI6
<b>[DI11]...[DI16]</b>	<i>L , I I...L , 16</i>	Digital input DI11...DI16 if VW3A3203 I/O extension module has been inserted
<b>[CD00]...[CD10]</b>	<i>C d 0 0...C d 1 0</i>	Virtual digital input CMD.0...CMD.10 in <b>[I/O profile]</b> , <i>a</i> configuration
<b>[CD11]...[CD15]</b>	<i>C d 1 1...C d 1 5</i>	Virtual digital input CMD.11...CMD.15 in <b>[I/O profile]</b> , <i>a</i> configuration
<b>[C101]...[C110]</b>	<i>C 1 0 1...C 1 1 0</i>	Virtual digital input CMD1.01...CMD1.10 with integrated Modbus Serial in <b>[I/O profile]</b> , <i>a</i> configuration
<b>[C111]...[C115]</b>	<i>C 1 1 1...C 1 1 5</i>	Virtual digital input CMD1.11...CMD1.15 with integrated Modbus Serial in <b>[I/O profile]</b> , <i>a</i> configuration
<b>[C301]...[C310]</b>	<i>C 3 0 1...C 3 1 0</i>	Virtual digital input CMD3.01...CMD3.10 with a fieldbus module in <b>[I/O profile]</b> , <i>a</i> configuration
<b>[C311]...[C315]</b>	<i>C 3 1 1...C 3 1 5</i>	Virtual digital input CMD3.11...CMD3.15 with a fieldbus module in <b>[I/O profile]</b> , <i>a</i> configuration

**[Acceleration 2] Acc 2 ★**

Time to accelerate from 0 to the **[Nominal motor freq.] Fr 5**. To have repeatability in ramps, the value of this parameter must be set according to the possibility of the application.

This parameter can be accessed if **[SwitchRamp2] Frt** is greater than 0 or if **[Ramp switch Assign] r P 5** is assigned.

Setting ( )	Description
0.0...6,000 s <sup>(1)</sup>	Setting range Factory setting: 5.0 s
<b>(1)</b> Range 0.01 to 99.99 s or 0.1 to 999.9 s or 1...6,000 s according to <b>[Ramp increment]</b> , <i>a</i> .	

**[Deceleration 2] d E 2 ★**

Time to decelerate from the [Nominal motor freq.] F r 5 to 0. To have repeatability in ramps, the value of this parameter must be set according to the possibility of the application.

This parameter can be accessed if [SwitchRamp2] F r E is greater than 0 or if [Ramp switch Assign] r P 5 is assigned.

Setting (C)	Description
0.0...6,000 s <sup>(1)</sup>	Setting range Factory setting: 5.0 s
(1) Range 0.01 to 99.99 s or 0.1 to 999.9 s or 1...6,000 s according to [Ramp increment] i n r .	

**[Dec.Ramp Adapt] b r A**

Deceleration ramp adaptation.

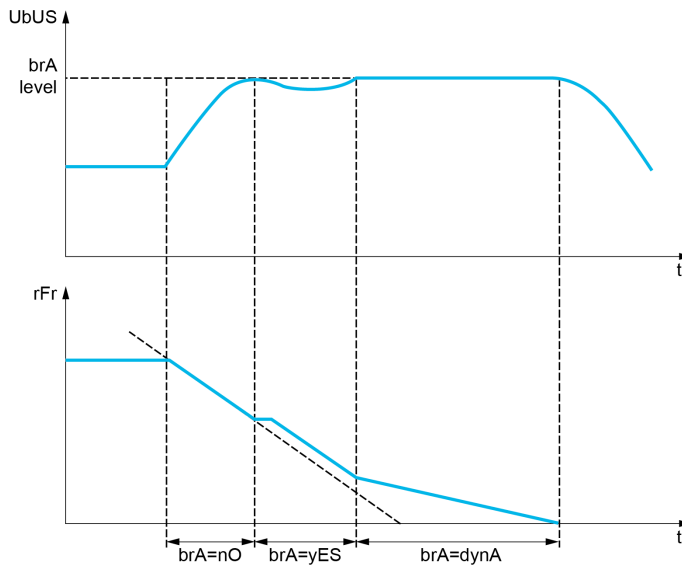

Activating this function automatically adapts the deceleration ramp, if this has been set at a too low value according to the inertia of the load, which can cause an overvoltage detected error.

The function is incompatible with applications requiring:

- Positioning on a ramp

Setting	Code / Value	Description
[No]	n o	Function inactive
[Yes]	y E 5	Function active, for applications that do not require strong deceleration Factory setting
[High torq. A]	d y n A	Addition of a constant current flow component. The [High torq. A] d y n A selection appears depending on the rating of the drive and [Motor control type] C E E . It enables stronger deceleration to be obtained than with [Yes] y E 5 . Use comparative testing to determine your selection When [Dec.Ramp Adapt] b r A is configured on [High torq. x] d y n X , the dynamic performances for braking are improved by the addition of a current flow component. The aim is to increase the iron loss and magnetic energy stored in the motor.

## Section 6.5

### [Generic functions] - [+/- speed]

#### [+/- speed] *u P d* - Menu

##### Access

[Complete settings] → [Generic functions] → [+/- speed]

##### About This Menu

This function can be accessed if reference channel [Ref Freq 2 Config] *F r 2* is set to [Ref Frequency via DI] *u P d t*

**NOTE:** This function cannot be used with some other functions.

2 types of operations are available:

- **Use of single action keys:** 2 digital inputs are required in addition to the operating directions. The input assigned to the “+ speed” command increases the speed, the input assigned to the “– speed” command decreases the speed.
- **Use of double action keys:** Only one digital input assigned to “+ speed” is required.

+/- speed with double-press buttons:

Description: 1 button pressed twice (2 steps) for each direction of rotation. A contact closes each time the button is pressed.

Setting	Released (– Speed)	First Press (Speed Maintained)	Second Press (Faster)
Forward button	–	a	a and b
Reverse button	–	c	c and d

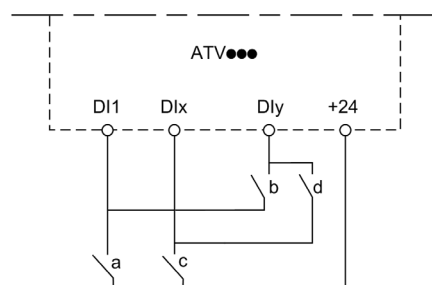

**DI1** Forward  
**DIx** Reverse  
**DIy** + speed

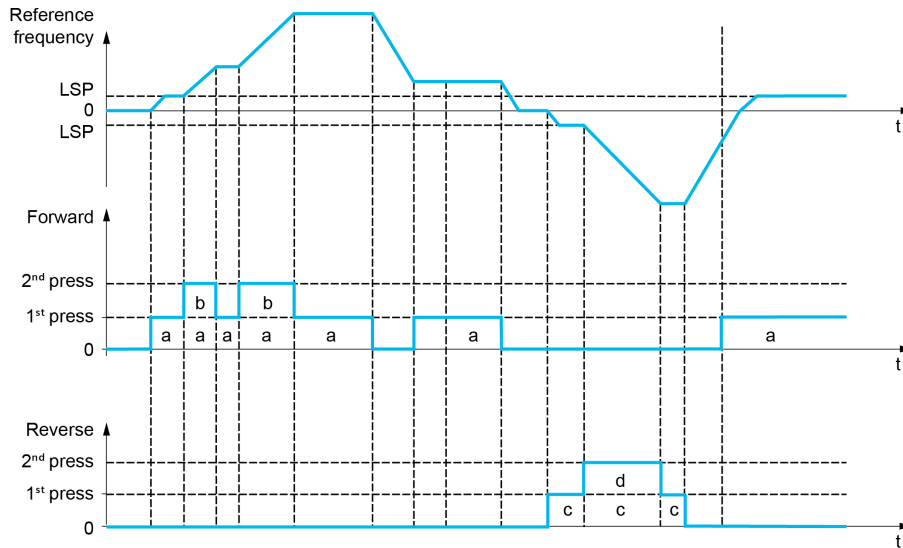

Do not use this +/- speed type with a 3-wire control.

Whichever type of operation is selected, the max. speed is set by **[High speed] H 5 P**.

**NOTE:** If the reference is switched via **[Freq Switch Assign] r F L** from any reference channel to another reference channel with "+/- speed", the value of reference **[Motor Frequency] r F r** (after ramp) may be copied at the same time in accordance with the **[Copy Ch1-Ch2] C d P** parameter.

This helps to prevent the speed from being incorrectly reset to zero when switching takes place.

**[+ Speed Assign] u 5 P**

Increase speed input assignment.

Function active if the assigned input or bit is at 1.

Setting	Code / Value	Description
[Not Assigned]	n 0	Not assigned <b>Factory setting</b>
[DI1]...[DI6]	L 1 1...L 1 6	Digital input DI1...DI6
[DI11]...[DI16]	L 1 1 1...L 1 1 6	Digital input DI11...DI16 if VW3A3203 I/O extension module has been inserted
[CD00]...[CD10]	C d 0 0...C d 1 0	Virtual digital input CMD.0...CMD.10 in <b>[I/O profile] i 0</b> configuration
[CD11]...[CD15]	C d 1 1...C d 1 5	Virtual digital input CMD.11...CMD.15 in <b>[I/O profile] i 0</b> configuration
[C101]...[C110]	C 1 0 1...C 1 1 0	Virtual digital input CMD1.01...CMD1.10 with integrated Modbus Serial in <b>[I/O profile] i 0</b> configuration
[C111]...[C115]	C 1 1 1...C 1 1 5	Virtual digital input CMD1.11...CMD1.15 with integrated Modbus Serial in <b>[I/O profile] i 0</b> configuration
[C301]...[C310]	C 3 0 1...C 3 1 0	Virtual digital input CMD3.01...CMD3.10 with a fieldbus module in <b>[I/O profile] i 0</b> configuration
[C311]...[C315]	C 3 1 1...C 3 1 5	Virtual digital input CMD3.11...CMD3.15 with a fieldbus module in <b>[I/O profile] i 0</b> configuration

**[- Speed Assign] d 5 P**

Down speed input assignment. See the assignment conditions.

Parameter settings identical to **[+ Speed Assign] u 5 P**.

Function active if the assigned input or bit is at 1.

**[Ref Frequency Save] 5 E r ★**

Reference frequency saves. This parameter can be accessed if **[+ Speed Assign] 4 5 P** is not set to **[Not Assigned] n 0** or **[- Speed Assign] d 5 P** is not set to **[Not Assigned] n 0**.

Associated with the "+/- speed" function, this parameter can be used to save the reference:

- When the run commands disappear (saved to RAM).
- When the supply mains or the run commands disappear (saved to EEPROM).

Therefore, next time the drive starts up, the speed reference is the last reference frequency saved.

Setting	Code / Value	Description
<b>[No save]</b>	<i>n 0</i>	Not saved <b>Factory setting</b>
<b>[Save to RAM]</b>	<i>r R P</i>	+/- speed with saving of the reference frequency in RAM
<b>[Save to EEprom]</b>	<i>E E P</i>	+/- speed with saving of the reference frequency in EEPROM

## Section 6.6

### [Generic functions] - [Stop configuration]

#### [Stop configuration] 5 5 5 - Menu

##### Access

[Complete settings] → [Generic functions] → [Stop configuration]

##### About This Menu

**NOTE:** This function cannot be used with some other functions.

##### [Type of stop] 5 5 5

Normal stop mode.

Stop mode on disappearance of the run command or appearance of a stop command.

Setting	Code / Value	Description
[On Ramp]	r P P	Stop on ramp <b>Factory setting</b>
[Fast stop]	F 5 5	Fast stop
[Freewheel]	n 5 5	Freewheel stop
[DC injection]	d C 1	DC injection stop.

##### [Freewheel stop] n 5 5

Freewheel stop.

The stop is activated when the input or the bit changes to 0. If the input returns to state 1 and the run command is still active, the motor will only restart if [2/3-wire control] 5 5 5 is set to [2-Wire Control] 2 5 and if [2-wire type] 5 5 5 is set to [Level] L 5 5 or [Fwd priority] P P 0. If not, a new run command must be sent.

Setting	Code / Value	Description
[Not Assigned]	n 0	Not assigned <b>Factory setting</b>
[CD00]...[CD10]	C d 0 0 ... C d 1 0	Virtual digital input CMD.0...CMD.10 in [I/O profile] 1 0 configuration
[CD11]...[CD15]	C d 1 1 ... C d 1 5	Virtual digital input CMD.11...CMD.15 in [I/O profile] 1 0 configuration
[C101]...[C110]	C 1 0 1 ... C 1 1 0	Virtual digital input CMD1.01...CMD1.10 with integrated Modbus Serial in [I/O profile] 1 0 configuration
[C111]...[C115]	C 1 1 1 ... C 1 1 5	Virtual digital input CMD1.11...CMD1.15 with integrated Modbus Serial in [I/O profile] 1 0 configuration
[C301]...[C310]	C 3 0 1 ... C 3 1 0	Virtual digital input CMD3.01...CMD3.10 with a fieldbus module in [I/O profile] 1 0 configuration
[C311]...[C315]	C 3 1 1 ... C 3 1 5	Virtual digital input CMD3.11...CMD3.15 with a fieldbus module in [I/O profile] 1 0 configuration
[DI1 (Low level)]...[DI6 (Low level)]	L 1 L ... L 6 L	Digital input DI1...DI6 used at low level
[DI11 (Low level)]...[DI16 (Low level)]	L 1 1 L ... L 1 6 L	Digital input DI11...DI16 used at low level if VW3A3203 I/O extension module has been inserted



**[Freewheel stop Thd] F F L** ★

Freewheel stop threshold.

Speed threshold below which the motor switches to freewheel stop.

This parameter supports switching from a ramp stop or a fast stop to a freewheel stop below a low speed threshold.

This parameter can be accessed if:

- **[Type of stop] S L L** is set to **[Fast stop] F S L** or **[On Ramp] r P P**, and
- **[Auto DC Injection] R d L** is not configured.

Setting ( )	Description
0.2...500.0 Hz	Setting range <b>Factory setting:</b> 0.2 Hz

**[Fast stop Assign] F S L**

Fast stop.

The stop is activated when the input changes to 0 or the bit changes to 1 (bit in **[I/O profile] i o** at 0).

If the input returns to state 1 and the run command is still active, the motor will only restart if **[2/3-wire control] L L L** is set to **[2-Wire Control] 2 L** and if **[2-wire type] L L L** is set to **[Level] L E L** or **[Fwd priority] P F o**.

If not, a new run command must be sent.

**NOTE:** This function cannot be used with some other functions.

Setting	Code / Value	Description
<b>[Not Assigned]</b>	n o	Not assigned <b>Factory setting</b>
<b>[CD00]...[CD10]</b>	C d 0 0 ... C d 1 0	Virtual digital input CMD.0...CMD.10 in <b>[I/O profile] i o</b> configuration
<b>[CD11]...[CD15]</b>	C d 1 1 ... C d 1 5	Virtual digital input CMD.11...CMD.15 in <b>[I/O profile] i o</b> configuration
<b>[C101]...[C110]</b>	C 1 0 1 ... C 1 1 0	Virtual digital input CMD1.01...CMD1.10 with integrated Modbus Serial in <b>[I/O profile] i o</b> configuration
<b>[C111]...[C115]</b>	C 1 1 1 ... C 1 1 5	Virtual digital input CMD1.11...CMD1.15 with integrated Modbus Serial in <b>[I/O profile] i o</b> configuration
<b>[C301]...[C310]</b>	C 3 0 1 ... C 3 1 0	Virtual digital input CMD3.01...CMD3.10 with a fieldbus module in <b>[I/O profile] i o</b> configuration
<b>[C311]...[C315]</b>	C 3 1 1 ... C 3 1 5	Virtual digital input CMD3.11...CMD3.15 with a fieldbus module in <b>[I/O profile] i o</b> configuration
<b>[DI1 (Low level)]...[DI6 (Low level)]</b>	L 1 L ... L 6 L	Digital input DI1...DI6 used at low level
<b>[DI11 (Low level)]...[DI16 (Low level)]</b>	L 1 1 L ... L 1 6 L	Digital input DI11...DI16 used at low level if VW3A3203 I/O extension module has been inserted

**[Ramp Divider] d C F** ★

Fast Stop deceleration ramp reduction coefficient.

The ramp that is enabled (**[Deceleration] d E L** or **[Deceleration 2] d E 2**) is then divided by this coefficient when stop requests are sent.

Value 0 corresponds to a minimum ramp time.

Setting ( )	Description
0...10	Setting range <b>Factory setting:</b> 4

[DC Injection Assign] *d C* ,

DC injection brake assignment.

<b>⚠ WARNING</b>
<p><b>UNINTENDED MOVEMENT</b></p> <ul style="list-style-type: none"> <li>Do not use DC injection to generate holding torque when the motor is at a standstill.</li> <li>Use a holding brake to keep the motor in the standstill position.</li> </ul> <p><b>Failure to follow these instructions can result in death, serious injury, or equipment damage.</b></p>

DC injection braking is initiated when the assigned input or bit changes to state 1.

If the input returns to state 0 and the run command is still active, the motor will only restart if [2/3-wire control] *l C C* is set to [2-Wire Control] *d C* and if [2-wire type] *l C l* is set to [Level] *L E L* or [Fwd priority] *P F o*. If not, a new run command must be sent.

**NOTE:** This function cannot be used with some other functions.

Setting	Code / Value	Description
[Not Assigned]	<i>n o</i>	Not assigned <b>Factory setting</b>
[DI1]...[DI6]	<i>L , l ... L , l B</i>	Digital input DI1...DI6
[DI11]...[DI16]	<i>L , l l ... L , l B</i>	Digital input DI11...DI16 if VW3A3203 I/O extension module has been inserted
[CD00]...[CD10]	<i>C d 0 0 ... C d 1 0</i>	Virtual digital input CMD.0...CMD.10 in [I/O profile] , <i>o</i> configuration
[CD11]...[CD15]	<i>C d 1 1 ... C d 1 5</i>	Virtual digital input CMD.11...CMD.15 in [I/O profile] , <i>o</i> configuration
[C101]...[C110]	<i>C 1 0 1 ... C 1 1 0</i>	Virtual digital input CMD1.01...CMD1.10 with integrated Modbus Serial in [I/O profile] , <i>o</i> configuration
[C111]...[C115]	<i>C 1 1 1 ... C 1 1 5</i>	Virtual digital input CMD1.11...CMD1.15 with integrated Modbus Serial in [I/O profile] , <i>o</i> configuration
[C301]...[C310]	<i>C 3 0 1 ... C 3 1 0</i>	Virtual digital input CMD3.01...CMD3.10 with a fieldbus module in [I/O profile] , <i>o</i> configuration
[C311]...[C315]	<i>C 3 1 1 ... C 3 1 5</i>	Virtual digital input CMD3.11...CMD3.15 with a fieldbus module in [I/O profile] , <i>o</i> configuration

[DC inject. level 1] , *d C* ★

DC injection current.

<b>NOTICE</b>
<p><b>OVERHEATING AND DAMAGE TO THE MOTOR</b></p> <p>Verify that the connected motor is properly rated for the DC injection current to be applied in terms of amount and time in order to avoid overheating and damage to the motor.</p> <p><b>Failure to follow these instructions can result in equipment damage.</b></p>

Level of DC injection braking current activated via digital input or selected as stop mode.

This parameter can be accessed if:

- [Type of stop] *S E E* is set to [DC injection] *d C* , or
- [DC.Brake DI] *d C* , is not set to [No] *n o*.

Setting ( )	Description
0.1...1.41 In <sup>(1)</sup>	Setting range This setting is independent of the [Auto DC Injection] <i>R d C</i> - function. <b>Factory setting:</b> 0.7 In <sup>(1)</sup>
(1) In corresponds to the rated drive current indicated in the Installation Manual and on the drive nameplate.	

**[DC injection time 1]  $t_{d1}$  ★**

DC injection time 1.

**NOTICE****OVERHEATING AND DAMAGE TO THE MOTOR**

Verify that the connected motor is properly rated for the DC injection current to be applied in terms of amount and time in order to avoid overheating and damage to the motor.

**Failure to follow these instructions can result in equipment damage.**

Maximum current injection time **[DC inject. level 1]  $t_{d1}$** . After this time, the injection current becomes **[DC inject. level 2]  $i_{d2}$** .

This parameter can be accessed if:

- **[Type of stop]  $S_{tE}$**  is set to **[DC injection]  $dC1$** , or
- **[DC.Brake DI]  $dC1$**  is not set to **[No]  $n0$** .

Setting (°)	Description
0.1...30 s	Setting range This setting is independent of the <b>[Auto DC Injection] <math>A_{dC}</math></b> - function. <b>Factory setting:</b> 0.5 s

**[DC inject. level 2]  $i_{d2}$  ★**

DC injection current 2.

**NOTICE****OVERHEATING AND DAMAGE TO THE MOTOR**

Verify that the connected motor is properly rated for the DC injection current to be applied in terms of amount and time in order to avoid overheating and damage to the motor.

**Failure to follow these instructions can result in equipment damage.**

Injection current activated by digital input or selected as stop mode once period **[DC injection time 1]  $t_{d1}$**  has elapsed.

This parameter can be accessed if:

- **[Type of stop]  $S_{tE}$**  is set to **[DC injection]  $dC1$** , or
- **[DC Injection Assign]  $dC1$**  is not set to **[No]  $n0$** .

Setting (°)	Description
0.1 $I_n^{(1)}$ ... <b>[DC inject. level 1] <math>t_{d1}</math></b>	Setting range This setting is independent of the <b>[Auto DC Injection] <math>A_{dC}</math></b> - function. <b>Factory setting:</b> 0.5 $I_n^{(1)}$
<b>(1)</b> $I_n$ corresponds to the rated drive current indicated in the Installation Manual and on the drive nameplate.	

[DC Inj Time 2] *h d l* ★

2nd DC injection time.

***NOTICE***

**OVERHEATING AND DAMAGE TO THE MOTOR**

Verify that the connected motor is properly rated for the DC injection current to be applied in terms of amount and time in order to avoid overheating and damage to the motor.

**Failure to follow these instructions can result in equipment damage.**

Maximum injection time [DC inject. level 2] *h d l 2* for injection, selected as stop mode only.

This parameter can be accessed if [Type of stop] *5 h h* is set to [DC injection] *h d l 1*.

Setting ( )	Description
0.1...30 s	Setting range This setting is independent of the [Auto DC Injection] <i>h d l</i> - function. <b>Factory setting:</b> 0.5 s

## Section 6.7

### [Generic functions] - [Auto DC injection]

#### [Auto DC injection] *F d C* - Menu

##### Access

[Complete settings] → [Generic functions] → [Auto DC injection]

##### About This Menu

This menu presents the automatic injection of motor current function. This is used to hold the rotor of the motor at the end of the deceleration ramp.

#### [Auto DC Injection] *F d C*

Automatic DC Injection.

 <b>DANGER</b>	
<b>HAZARD OF ELECTRIC SHOCK, EXPLOSION, OR ARC FLASH</b>	
If the parameter [Auto DC Injection] <i>F d C</i> is set to [Continuous] <i>C E</i> , DC injection is always active, even if the motor does not run.	
<ul style="list-style-type: none"> <li>• Verify that using this setting does not result in unsafe conditions.</li> </ul>	
<b>Failure to follow these instructions will result in death or serious injury.</b>	

 <b>WARNING</b>	
<b>UNINTENDED MOVEMENT</b>	
<ul style="list-style-type: none"> <li>• Do not use DC injection to generate holding torque when the motor is at a standstill.</li> <li>• Use a holding brake to keep the motor in the standstill position.</li> </ul>	
<b>Failure to follow these instructions can result in death, serious injury, or equipment damage.</b>	

Automatic current injection on stopping (at the end of the ramp).

Setting ( )	Code / Value	Description
[No]	<i>n o</i>	No injection
[Yes]	<i>y e 5</i>	Adjustable injection time <b>Factory setting</b>
[Continuous]	<i>C E</i>	Continuous standstill injection

#### [Auto DC inj Level 1] *S d C 1* ★

Auto DC injection level 1.

<b>NOTICE</b>	
<b>OVERHEATING AND DAMAGE TO THE MOTOR</b>	
Verify that the connected motor is properly rated for the DC injection current to be applied in terms of amount and time in order to avoid overheating and damage to the motor.	
<b>Failure to follow these instructions can result in equipment damage.</b>	

Level of standstill DC injection current.

This parameter can be accessed if [Auto DC Injection] *F d C* is not set to [No] *n o*.

Setting ( )	Description
0...1.1 In <sup>(1)</sup>	Setting range <b>Factory setting:</b> 0.7 In <sup>(1)</sup>
<b>(1)</b> In corresponds to the rated drive current indicated in the Installation Manual and on the drive nameplate.	

**[Auto DC Inj Time 1] E d C 1** ★

Auto DC injection time 1.

<b>NOTICE</b>	
<b>OVERHEATING AND DAMAGE TO THE MOTOR</b>	
Verify that the connected motor is properly rated for the DC injection current to be applied in terms of amount and time in order to avoid overheating and damage to the motor.	
<b>Failure to follow these instructions can result in equipment damage.</b>	

This parameter can be accessed if **[Auto DC Injection] R d C** is not set to **[No] n a**.

Setting ( )	Description
0.1...30.0 s	Setting range <b>Factory setting:</b> 0.5 s

**[Auto DC inj Level 2] S d C 2** ★

Auto DC injection level 2.

<b>NOTICE</b>	
<b>OVERHEATING AND DAMAGE TO THE MOTOR</b>	
Verify that the connected motor is properly rated for the DC injection current to be applied in terms of amount and time in order to avoid overheating and damage to the motor.	
<b>Failure to follow these instructions can result in equipment damage.</b>	

Second level of standstill DC injection current.

This parameter can be accessed if **[Auto DC Injection] R d C** is not set to **[No] n a**.

Setting ( )	Description
0...1.1 In <sup>(1)</sup>	Setting range <b>Factory setting:</b> 0.5 In <sup>(1)</sup>
<b>(1)</b> In corresponds to the rated drive current indicated in the Installation Manual and on the drive nameplate.	

[Auto DC Inj Time 2] *U D C 2* ★

Auto DC injection time 2.

### NOTICE

**OVERHEATING AND DAMAGE TO THE MOTOR**

Verify that the connected motor is properly rated for the DC injection current to be applied in terms of amount and time in order to avoid overheating and damage to the motor.

**Failure to follow these instructions can result in equipment damage.**

Second standstill injection time.

This parameter can be accessed if [Auto DC Injection] *U D C* is set to [YES] *Y E 5*.

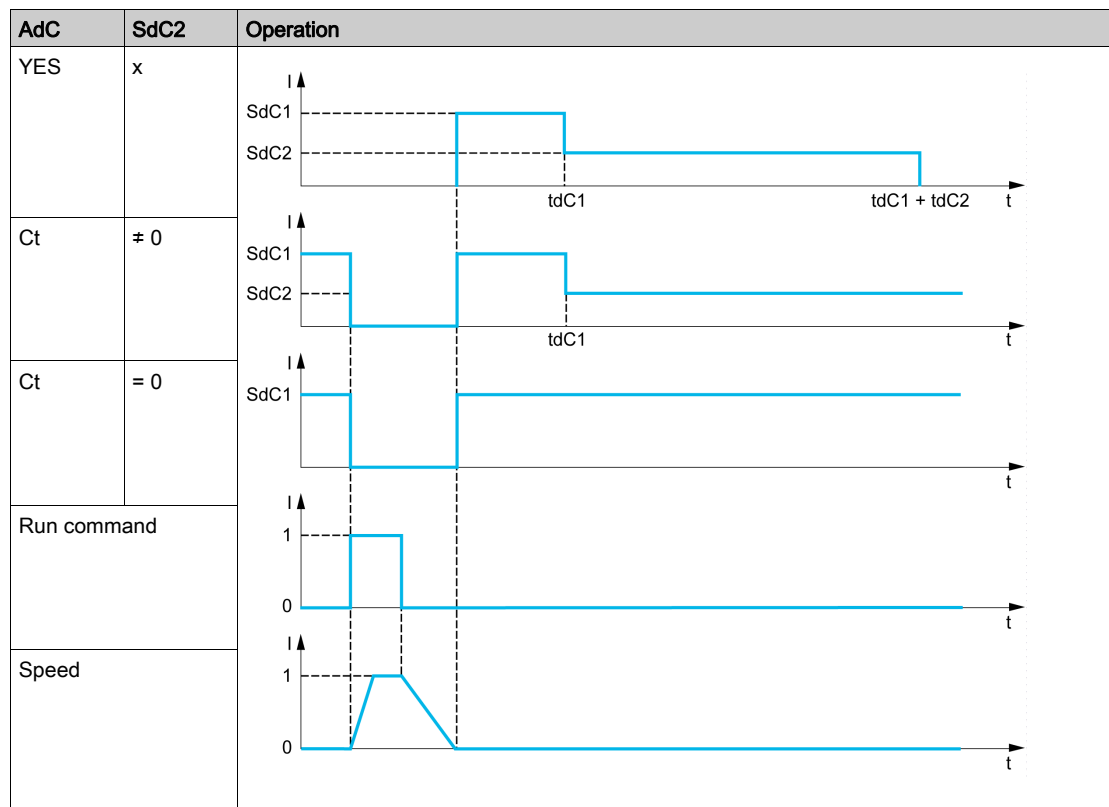

Setting ( )	Description
0.0...30.0 s	Setting range Factory setting: 0.0 s

# Section 6.8

## [Generic functions] - [Jog]

### [Jog] JOG - Menu

#### Access

[Complete settings] → [Generic functions] → [Jog]

#### [Jog Assign] JOG

Jog assignment.

The JOG function is only active if the command channel and the reference channels are on the terminals.

This function can be used if:

- [PID Feedback] PIF is set to [Not Configured] no, and
- [Ref Freq 2 Config] FR2 is not set to [Ref Frequency via DI] uPdE.

The function is active when the assigned input or bit is at 1.

Example: 2-wire control operation ([2/3-Wire Control] tLl = [2-Wire Control] zL).

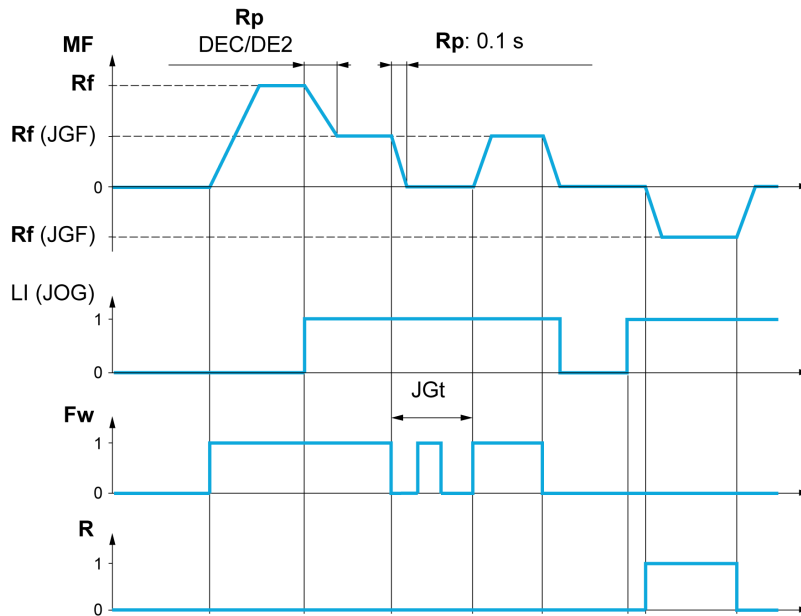

- MF Motor frequency
- Rf Reference
- Rp Ramp
- Rp: 0.1 s Ramp forced to 0.1 S
- Fw Forward
- R Reverse

Setting	Code / Value	Description
[Not Assigned]	no	Not assigned <b>Factory setting</b>
[DI1]...[DI6]	L, I...L, B	Digital input DI1...DI6
[DI11]...[DI16]	L, I I...L, IB	Digital input DI11...DI16 if VW3A3203 I/O extension module has been inserted
[CD00]...[CD10]	C d 0 0...C d 1 0	Virtual digital input CMD.0...CMD.10 in [I/O profile] , no configuration
[CD11]...[CD15]	C d 1 1...C d 1 5	Virtual digital input CMD.11...CMD.15 in [I/O profile] , no configuration
[C101]...[C110]	C 1 0 1...C 1 1 0	Virtual digital input CMD1.01...CMD1.10 with integrated Modbus Serial in [I/O profile] , no configuration



Setting	Code / Value	Description
[C111]...[C115]	C 1 1 1...C 1 1 5	Virtual digital input CMD1.11...CMD1.15 with integrated Modbus Serial in [I/O profile] , n o configuration
[C301]...[C310]	C 3 0 1...C 3 1 0	Virtual digital input CMD3.01...CMD3.10 with a fieldbus module in [I/O profile] , n o configuration
[C311]...[C315]	C 3 1 1...C 3 1 5	Virtual digital input CMD3.11...CMD3.15 with a fieldbus module in [I/O profile] , n o configuration

### [Jog frequency] J G F ★

This parameter can be accessed if [Jog Assign] J o G is not set to [No] n o.

Setting (°)	Description
0.0...10.0 Hz	Setting range Factory setting: 10.0 Hz

### [Jog Delay] J G E ★

This parameter can be accessed if [Jog Assign] ( J o G ) is not set to [No] ( n o ).

Setting (°)	Description
0.0...2.0 s	Setting range Factory setting: 0.5 s

## Section 6.9

### [Generic functions] - [Preset speeds]

#### [Preset speeds] P 5 5 - Menu

##### Access

[Complete settings] → [Generic functions] → [Preset speeds]

##### About This Menu

**NOTE:** This function cannot be used with some other functions.

##### Combination Table for Preset Speed Inputs

2, 4, 8 or 16 speeds can be preset, requiring 1, 2, 3 or 4 digital inputs respectively.

It is necessary to configure:

- 2 and 4 speeds in order to obtain 4 speeds.
- 2, 4 and 8 speeds in order to obtain 8 speeds.
- 2, 4, 8 and 16 speeds in order to obtain 16 speeds.

16 Preset Freq (PS16)	8 Preset Freq (PS8)	4 Preset Freq (PS4)	2 Preset Freq (PS2)	Speed Reference
0	0	0	0	Reference 1 <sup>(1)</sup>
0	0	0	1	SP2
0	0	1	0	SP3
0	0	1	1	SP4
0	1	0	0	SP5
0	1	0	1	SP6
0	1	1	0	SP7
0	1	1	1	SP8
1	0	0	0	SP9
1	0	0	1	SP10
1	0	1	0	SP11
1	0	1	1	SP12
1	1	0	0	SP13
1	1	0	1	SP14
1	1	1	0	SP15
1	1	1	1	SP16

(1) Reference 1 = 5 P 1, refer to diagram (see page 134)

#### [2 Preset Freq] P 5 2

2 preset freq assignment.

Setting	Code / Value	Description
[Not Assigned]	n a	Not assigned <b>Factory setting</b>
[DI1]...[DI6]	L , I ... L , 6	Digital input DI1...DI6
[DI11]...[DI16]	L , I I ... L , 16	Digital input DI11...DI16 if VW3A3203 I/O extension module has been inserted
[CD00]...[CD10]	C d 0 0 ... C d 1 0	Virtual digital input CMD.0...CMD.10 in <b>[I/O profile]</b> , a configuration
[CD11]...[CD15]	C d 1 1 ... C d 1 5	Virtual digital input CMD.11...CMD.15 in <b>[I/O profile]</b> , a configuration

Setting	Code / Value	Description
[C101]...[C110]	C 1 0 1 ... C 1 1 0	Virtual digital input CMD1.01...CMD1.10 with integrated Modbus Serial in <b>[I/O profile]</b> , <b>o</b> configuration
[C111]...[C115]	C 1 1 1 ... C 1 1 5	Virtual digital input CMD1.11...CMD1.15 with integrated Modbus Serial in <b>[I/O profile]</b> , <b>o</b> configuration
[C301]...[C310]	C 3 0 1 ... C 3 1 0	Virtual digital input CMD3.01...CMD3.10 with a fieldbus module in <b>[I/O profile]</b> , <b>o</b> configuration
[C311]...[C315]	C 3 1 1 ... C 3 1 5	Virtual digital input CMD3.11...CMD3.15 with a fieldbus module in <b>[I/O profile]</b> , <b>o</b> configuration

**[4 Preset Freq] P 5 4**

4 preset freq assignment.

Identical to **[2 Preset Freq] P 5 2**

To obtain 4 speeds, you must also configure 2 speeds.

**[8 Preset Freq] P 5 8**

8 preset freq assignment.

Identical to **[2 Preset Freq] P 5 2**

To obtain 8 speeds, you must also configure 2 and 4 speeds.

**[16 Preset Freq] P 5 16**

16 preset freq assignment.

Identical to **[2 Preset Freq] P 5 2**

To obtain 16 speeds, you must also configure 2, 4 and 8 speeds.

**[Preset speed 2] S P 2 ★**

Preset speed 2. See the combination table for preset speed inputs (*see page 162*).

Setting ( )	Description
0.0...500.0 Hz	Setting range <b>Factory setting:</b> 10.0 Hz

**[Preset speed 3] S P 3 ★**

Preset speed 3. See the combination table for preset speed inputs (*see page 162*).

Setting ( )	Description
0.0...500.0 Hz	Setting range <b>Factory setting:</b> 20.0 Hz

**[Preset speed 4] S P 4 ★**

Preset speed 4. See the combination table for preset speed inputs (*see page 162*).

Setting ( )	Description
0.0...500.0 Hz	Setting range <b>Factory setting:</b> 30.0 Hz

**[Preset speed 5] 5 P 5 ★**

Preset speed 5. See the combination table for preset speed inputs (*see page 162*).

Setting ( )	Description
0.0...500.0 Hz	Setting range <b>Factory setting:</b> 25.0 Hz

**[Preset speed 6] 5 P 6 ★**

Preset speed 6. See the combination table for preset speed inputs (*see page 162*).

Setting ( )	Description
0.0...500.0 Hz	Setting range <b>Factory setting:</b> 30.0 Hz

**[Preset speed 7] 5 P 7 ★**

Preset speed 7. See the combination table for preset speed inputs (*see page 162*).

Setting ( )	Description
0.0...500.0 Hz	Setting range <b>Factory setting:</b> 35.0 Hz

**[Preset speed 8] 5 P 8 ★**

Preset speed 8. See the combination table for preset speed inputs (*see page 162*).

Setting ( )	Description
0.0...500.0 Hz	Setting range <b>Factory setting:</b> 40.0 Hz

**[Preset speed 9] 5 P 9 ★**

Preset speed 9. See the combination table for preset speed inputs (*see page 162*).

Setting ( )	Description
0.0...500.0 Hz	Setting range <b>Factory setting:</b> 45.0 Hz

**[Preset speed 10] 5 P 10 ★**

Preset speed 10. See the combination table for preset speed inputs (*see page 162*).

Setting ( )	Description
0.0...500.0 Hz	Setting range <b>Factory setting:</b> 50.0 Hz

**[Preset speed 11] 5 P 11 ★**

Preset speed 11. See the combination table for preset speed inputs (*see page 162*).

Setting ( )	Description
0.0...500.0 Hz	Setting range <b>Factory setting:</b> 55.0 Hz

**[Preset speed 12] 5 P 12 ★**

Preset speed 12. See the combination table for preset speed inputs (*see page 162*).

Setting ( )	Description
0.0...500.0 Hz	Setting range <b>Factory setting:</b> 60.0 Hz

**[Preset speed 13] 5 P 13 ★**

Preset speed 13. See the combination table for preset speed inputs (*see page 162*).

Setting ( )	Description
0.0...500.0 Hz	Setting range <b>Factory setting:</b> 70.0 Hz

**[Preset speed 14] 5 P 14 ★**

Preset speed 14. See the combination table for preset speed inputs (*see page 162*).

Setting ( )	Description
0.0...500.0 Hz	Setting range <b>Factory setting:</b> 80.0 Hz

**[Preset speed 15] 5 P 15 ★**

Preset speed 15 See the combination table for preset speed inputs (*see page 162*).

Setting ( )	Description
0.0...500.0 Hz	Setting range <b>Factory setting:</b> 90.0 Hz

**[Preset speed 16] 5 P 16 ★**

Preset speed 16. See the combination table for preset speed inputs (*see page 162*).

Setting ( )	Description
0.0...500.0 Hz	Setting range <b>Factory setting:</b> 100.0 Hz

## Section 6.10

### [Generic functions] - [Jump frequency]

#### [Jump frequency] JLF - Menu

##### Access

[Complete settings] → [Jump frequency]

##### About This Menu

This function helps to prevent prolonged operation within an adjustable range around the regulated frequency.

This function can be used to help prevent reaching a frequency, which could cause resonance. Setting the parameter to 0 disables the function.

The following figure is an example of the jump frequency function with one skip frequency defined by [Skip Frequency] JPF:

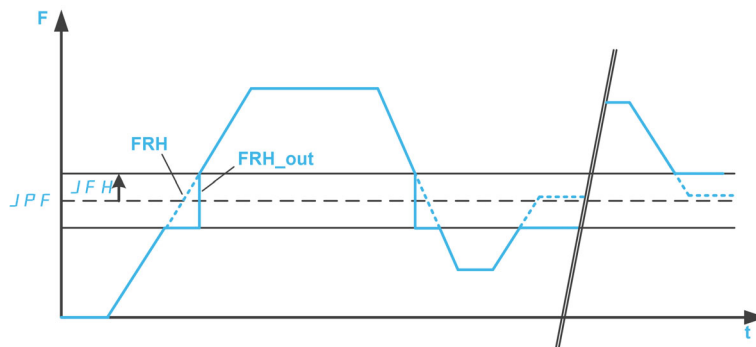

F Frequency  
 t time  
 JPF [Skip frequency]  
 JFH [Skip.Freq.Hysteresis]  
 FRH [Pre-Ramp Ref Freq]  
 FRH\_out [Pre-Ramp Ref Freq] after the jump frequency function

#### [Skip Frequency] JPF

Jump frequency.

Setting ( )	Description
0.0...500.0 Hz	Setting range <b>Factory setting:</b> 0.0 Hz

#### [Skip Frequency 2] JF2

Jump frequency 2.

Setting ( )	Description
0.0...500.0 Hz	Setting range <b>Factory setting:</b> 0.0 Hz

#### [3rd Skip Frequency] JF3

Jump frequency 3.

Setting ( )	Description
0.0...500.0 Hz	Setting range <b>Factory setting:</b> 0.0 Hz

**[Skip.Freq.Hysteresis] JFH** ★

Jump frequency bandwidth.

This parameter can be accessed if at least one skip frequency  $JPF$ ,  $JF2$ , or  $JF3$  is different from 0.

Skip frequency range: between  $JPF - JFH$  and  $JPF + JFH$  for example.

This adjustment is common to the 3 frequencies  $JPF$ ,  $JF2$ ,  $JF3$ .

Setting ( )	Description
0.1...10.0 Hz	Setting range Factory setting: 1.0 Hz

# Section 6.11

## [Generic functions] - [Define system units] 5 4 C - Menu

### [Define system units] 5 4 C - Menu

**Access**

[Complete settings] → [Generic functions] → [Define system units]

**About This Menu**

In order to be easy to configure, commission, operate, and maintain, the drive uses the application units.

The physicals that are concerned by application units are:

- Pressure values
- Flow rate values
- Temperature values
- Currency values

**NOTE:** Some other default system units are automatically deduced from configurable system units or from other parameters.

System unit applies by default to all communication parameters and HMI (Plain Text Display Terminal, Web server, DTM-based software).

When a system unit is changed, there is no rescaling of values. Numerical values are kept, but the meaning of these values is not the same:

- After a change, the behavior of the product will not change (the system stays numerically the same).
- If new values are written through communication or through HMI in new unit, then the behavior is impacted. In that case, all parameters should be reconfigured according to the new selected unit.
- In order to avoid issues due to a modification of system unit parameters, system units should be modified only during the installation of the product and before the commissioning of the functions.

The precision of the physical values is selected at the same time as the unit.

By default, values are signed.

Default range of values are:

16 bits values	32 bits values
-32,768...32,767	-2,147,483,648...2,147,483,648

### [P sensor unit] 5 4 P r

Default system application unit used for pressure.

Available pressure units:

Unit	Symbol	Conversion
Kilo Pascal	kPa	100 kPa = 1 bar
Millibar	mbar	
Bar	bar	
Pound / square inch (lb/in <sup>2</sup> )	psi psig	14.5 psi = 1 bar
Inch H2O Inch water gauge Inch water column	inH2O inWG inWC	1 inH2O 4°C = 0.0024908891 bar (0.036127292 psi)
Feet water gauge Feet water column Feet	ftWG ftWC ft	1 inH2O 4°C = 0.0298906692 bar (0.433527504 psi)
Meter water gauge Meter water column Meter	mWG mWC (mCE) m	1 mH2O(4°C) = 0.0980665 bar (1.42233433 psi)
Inch of mercury	inHg	1 inHg = 0.0338638864 bar (0.491154147 psi)



Unit	Symbol	Conversion
Percentage	%	–
w/o unit	–	–

Setting	Code / Value	Description
[1Kpa]	<i>P A</i>	1 kpa
[1mbar]	<i>1 0 b A r</i>	1 mbar
[1Bar]	<i>b A r</i>	1 bar
[0.1Bar]	<i>0. 1 b A r</i>	0.1 bar <b>Factory setting</b>
[0.01Bar]	<i>0. 0 1 b A r</i>	0.01 bar
[1 PSI]	<i>P S I</i>	1 Psi
[0.1 PSI]	<i>0. 1 P S I</i>	0.1 psi
[1 PSIG]	<i>P S I G</i>	1 Psig
[0.1 PSIG]	<i>0. 1 P S I G</i>	0.1 Psig
[1inH2O]	<i>1 i n H 2 O</i>	1 inH2O
[1inWg]	<i>1 i n W G</i>	1 inWg
[1inWC]	<i>1 i n W C</i>	1 inWc
[1 FtWg]	<i>1 F t W G</i>	1 FtWg
[1 FtWC]	<i>1 F t W C</i>	1 FtWC
[1 Ft]	<i>1 F t</i>	1 Ft
[1 MWG]	<i>1 0 W G</i>	1 mWg
[0.1 MWG]	<i>0. 1 0 W G</i>	0.1 mWg
[1 MWC]	<i>1 0 W C</i>	1 mWC
[0.1 MWC]	<i>0. 1 0 W C</i>	0.1 mWC
[1m]	<i>1 0</i>	1 m
[0.1 m]	<i>0. 1 0</i>	0.1 m
[1 inHG]	<i>1 i n H G</i>	1 inHg
[0.1%]	<i>0. 1 ?</i>	0.1%
[0.1]	<i>0. 1 W ? o</i>	0.1 w/o

### [Flow rate unit] *S u F r*

Default system application unit used for flow rate.

Available flow units:

Unit	Symbol	Conversion
Liter / second	l/s	–
Liter / minute	l/min	–
Liter / hour	l/h	–
Cubic decimeter / minute	dm <sup>3</sup> /min	–
Cubic meter / second	m <sup>3</sup> /s	–
Cubic meter / minute	m <sup>3</sup> /min	–
Cubic meter / hour	m <sup>3</sup> /h	–
Gallon per second	gal/s	1 usgal = 3,785411784 l
Gallon per minute	gal/min; GPM	–
Gallon per hour	gal/h	–
Cubic feet / second	ft <sup>3</sup> /s	1 ft <sup>3</sup> = 28.317 l
Cubic feet / minute	ft <sup>3</sup> /min; CFM, SCFM	–
Cubic feet / hour	ft <sup>3</sup> /h	–
Percentage	%	–
w/o unit	–	–

Setting	Code / Value	Description
[1 L/s]	<i>IL S</i>	L/s
[l/s]	<i>D IL S</i>	0.1 L/s
[1 L/m]	<i>IL n</i>	L/m
[1 L/h]	<i>IL h</i>	L/h
[1 dm3/mn]	<i>ld n n n</i>	d3/m
[1 m3/s]	<i>ln S S</i>	M3/s
[0.1 m3/s]	<i>D ln S S</i>	0.1 M3/s
[1m3/m]	<i>ln S n n</i>	M3/min
[0.1 m3/m]	<i>D ln S n n</i>	0.1 M3/min
[1 m3/h]	<i>ln S h</i>	1 M3/h
[0.1m3/h]	<i>D ln S h</i>	0.1 M3/h <b>Factory setting</b>
[1 gal/s]	<i>IG P S</i>	1 Gal/s
[1 GPM]	<i>IG P n</i>	1 GPM
[1 gal/h]	<i>IG P H</i>	1 Gal/h
[1 ft3/s]	<i>IC F S</i>	1 ft3/s
[1CFM]	<i>IC F n</i>	1 CFM
[1SCFM]	<i>IS C F n</i>	1 SCFM
[1 Ft3/h]	<i>IC F H</i>	1 ft3/h
[1 Kg/s]	<i>IG S</i>	1 kg/s
[1 Kg/m]	<i>IG n</i>	1 kg/m
[1 Kg/h]	<i>IG H</i>	1 kg/h
[1 Lb/s]	<i>IL b S</i>	1 lb/s
[1 Lb/m]	<i>IL b n</i>	1 lb/m
[1 Lb/h]	<i>IL b H</i>	1 lb/h
[0.1%]	<i>D IPC</i>	0.1%
[0.1]	<i>D IW o</i>	0.1 w/o

**[Temperature unit] S u t P**

Default system application unit used for temperature.

Available temperature units:

Unit	Symbol	Conversion
Celsius Degree	°C	-
Fahrenheit Degree	°F	TF = 9/5*Tc+32
Percentage	%	-
w/o unit	-	-

Setting	Code / Value	Description
[0.1°C]	<i>D IC</i>	0.1 °C <b>Factory setting</b>
[0.1°F]	<i>D IF</i>	0.1 °F
[0.1%]	<i>D IPC</i>	0.1%
[0.1]	<i>D IW o</i>	0.1 w/o

**[Currency unit list] S U C U**

Default system application unit used for currency.

Setting	Code / Value	Description
[EURO]	<i>E u r o</i>	Euro
[\$]	<i>d o L L A r</i>	Dollar
[£]	<i>P o u n d</i>	Pound
[Krone]	<i>K r</i>	Krone
[Renminbi]	<i>r n b</i>	Renminbi <b>Factory setting</b>
[Other]	<i>o t H E r</i>	Other

**[Liquid Density] r H o**

Density of the fluid to be pumped.

This parameter can be accessed if **[Access Level] L R C** is not set to **[Expert] E P r**.

Setting	Description
100...10,000 kg/m3	Setting range <b>Factory setting:</b> 1000 kg/m3

## Section 6.12

### [Generic functions] - [PID controller]

#### What Is in This Section?

This section contains the following topics:

Topic	Page
[PID controller] <i>P i d</i> - Overview	173
[PID Feedback] <i>F d b</i> - Menu	177
[PID Reference] <i>r F</i> - Menu	183
[PID preset references] <i>P r i</i> - Menu	186
[PID Reference] <i>r F</i> - Menu	188
[Settings] <i>S t</i> - Menu	189

## [PID controller] $P_{id}$ - Overview

### About This Menu

**NOTE:** This function cannot be used with some other functions.

### Block Diagram

The function is activated by assigning an analog input to the PID feedback (measurement).

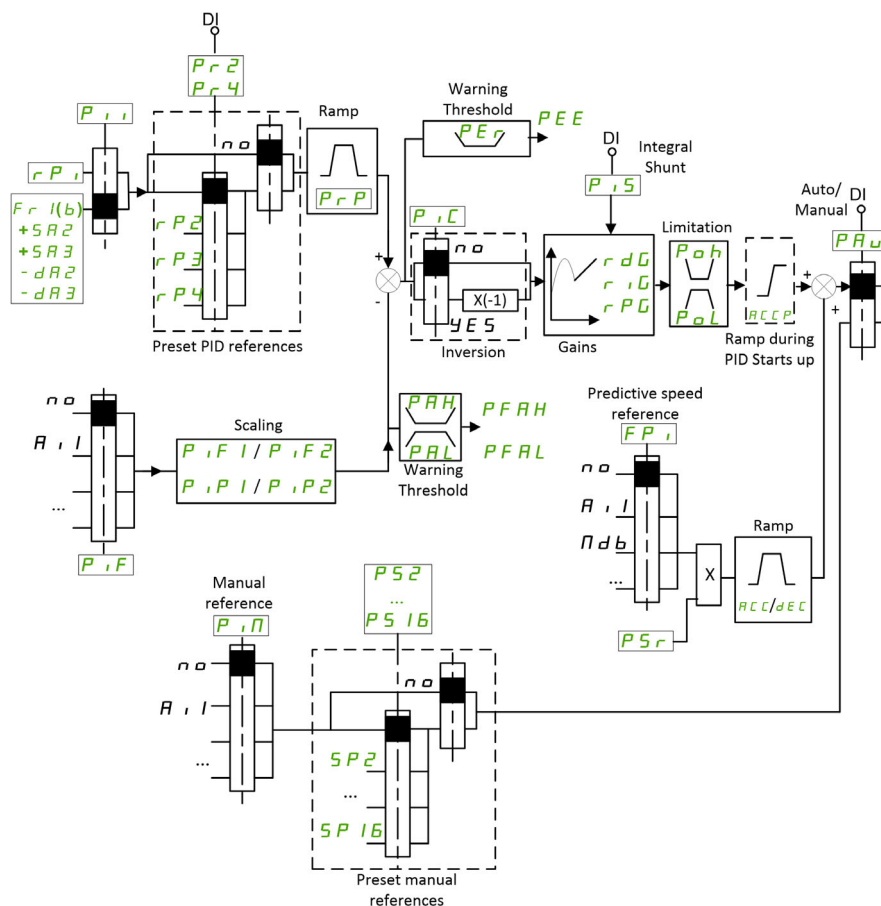

The PID feedback needs to be assigned to one of the analog inputs AI1 to AI5 or a pulse input, according to whether any I/O extension module has been inserted.

The PID reference needs to be assigned to the following parameters:

- Preset references via digital inputs ([Ref PID Preset 2]  $rP2$ , [Ref PID Preset 3]  $rP3$ , [Ref PID Preset 4]  $rP4$ ).
- In accordance with the configuration of [Intern PID Ref]  $P_{ii}$ :
  - [Internal PID ref]  $rP_i$ , or
  - Reference A [Ref Freq 1 Config]  $F_{r1}$ .

**Combination Table for Preset PID References:**

DI (Pr 4)	DI (Pr 2)	Pr 2 = no	Reference
0	0		
0	1		r P 2
1	0		r P 3
1	1		r P 4

A predictive speed reference can be used to initialize the speed on restarting the process.

Scaling of feedback and references:

- **[Min PID feedback] P , F 1, [Max PID feedback] P , F 2** parameters can be used to scale the PID feedback (sensor range). This scale must be maintained for all other parameters.
- **[Min PID Process] P , P 1, [Max PID Process] P , P 2** parameters can be used to scale the adjustment range, for example the reference. **Check that the adjustment range remains within the sensor range.**

The maximum value of the scaling parameters is 32,767. To facilitate the installation, it is recommended to use values as close as possible to this maximum level, while retaining powers of 10 in relation to the actual values. The scaling is without unit if **[Type of control] t o c t** is set to **[NA] n A**, in % if set to **[OTHER] o t H E r**, in process unit if set to **[PRESSURE] P r E S S** or **[FLOW] F L o W**.

**Example**

Adjustment of the volume in a tank, 6...15 m<sup>3</sup>.

- Probe used 4-20 mA, 4.5 m<sup>3</sup> for 4 mA and 20 m<sup>3</sup> for 20 mA, with the result that **P , F 1 = 4,500** and **P , F 2 = 20,000**.
- Adjustment range 6 to 15 m<sup>3</sup>, with the result that **P , P 1 = 6,000** (min. reference) and **P , P 2 = 15,000** (max. reference).
- Example references:
  - **r P 1** (internal reference) = 9,500
  - **r P 2** (preset reference) = 6,500
  - **r P 3** (preset reference) = 8,000
  - **r P 4** (preset reference) = 11,200

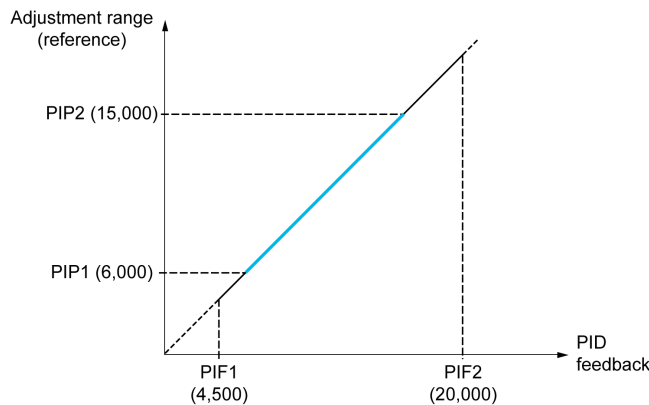

Other parameters:

- Reversal of the direction of correction **[PID Inversion] P , C**. If **[PID Inversion] P , C** is set to **[No] n o**, the speed of the motor increases when the detected error is positive (for example pressure control with a compressor). If **[PID Inversion] P , C** is set to **[Yes] Y E S**, the speed of the motor decreases when the detected error is positive (for example temperature control using a cooling fan).
- The integral gain may be short-circuited by a digital input.
- A warning on the **[PID feedback Assign] P , F** may be configured.
- A warning on the **[PID error] r P E** may be configured.

## "Manual - Automatic" Operation with PID

This function combines the PID controller, the preset speeds, and a manual reference. Depending on the state of the digital input, the speed reference is given by the preset speeds or by a manual reference input via the PID function.

Manual PID reference **[Manual PID reference]**  $P_{17}$ :

- Analog inputs AI1 to AI5
- Pulse inputs

Predictive speed reference **[Predictive Speed Ref]**  $F_{P1}$ :

- **[AI1]**  $A_{17}$ : analog input
- **[AI2]**  $A_{18}$ : analog input
- **[AI3]**  $A_{19}$ : analog input
- **[AI4]**  $A_{20}$ : analog input if VW3A3203 I/O extension module has been inserted
- **[AI5]**  $A_{21}$ : analog input if VW3A3203 I/O extension module has been inserted
- **[DI5 PulseInput Assignment]**  $P_{15}$ : pulse input
- **[DI6 PulseInput Assignment]**  $P_{16}$ : pulse input
- **[Ref.Freq-Rmt.Term]**  $L_{11}$ : Plain Text Display Terminal
- **[Modbus]**  $M_{12}$ : integrated Modbus
- **[Com. Module]**  $M_{13}$ : fieldbus option module (if inserted)

## Setting Up the PID Controller

### 1. Configuration in PID mode.

Refer to the Block Diagram ([see page 173](#)).

### 2. Perform a test in factory settings mode.

To optimize the drive, adjust **[PID Prop.Gain]**  $r_{P1}$  or **[PID Intgl.Gain]**  $r_{I1}$  gradually and independently, and observe the effect on the PID feedback in relation to the reference.

### 3. If the factory settings are unstable or the reference is incorrect.

Step	Action
1	Perform a test with a speed reference in Manual mode (without PID controller) and with the drive on load for the speed range of the system: <ul style="list-style-type: none"> <li>• In steady state, the speed must be stable and comply with the reference, and the PID feedback signal must be stable.</li> <li>• In transient state, the speed must follow the ramp and stabilize quickly, and the PID feedback must follow the speed. If not, see the settings for the drive and/or sensor signal and wiring.</li> </ul>
2	Switch to PID mode.
3	Set <b>[PID ramp]</b> $r_{rP}$ to the minimum permitted by the mechanism without triggering an <b>[DC Bus Overvoltage]</b> $o_{bF}$ .
4	Set the integral gain <b>[PID Intgl.Gain]</b> $r_{I1}$ to minimum.
5	Leave the derivative gain <b>[PID derivative gain]</b> $r_{dG}$ at 0.
6	Observe the PID feedback and the reference.
7	Switch the drive ON/OFF a number of times or vary the load or reference rapidly a number of times.
8	Set the proportional gain <b>[PID Prop.Gain]</b> $r_{P1}$ in order to ascertain the compromise between response time and stability in transient phases (slight overshoot and 1 to 2 oscillations before stabilizing).
9	If the reference varies from the preset value in steady state, gradually increase the integral gain <b>[PID Intgl.Gain]</b> $r_{I1}$ , reduce the proportional gain <b>[PID Prop.Gain]</b> $r_{P1}$ in the event of instability (pump applications), find a compromise between response time and static precision (see diagram).
10	Lastly, the derivative gain may permit the overshoot to be reduced and the response time to be improved, although this is more difficult to obtain a compromise in terms of stability, as it depends on 3 gains.
11	Perform in-production tests over the whole reference range.

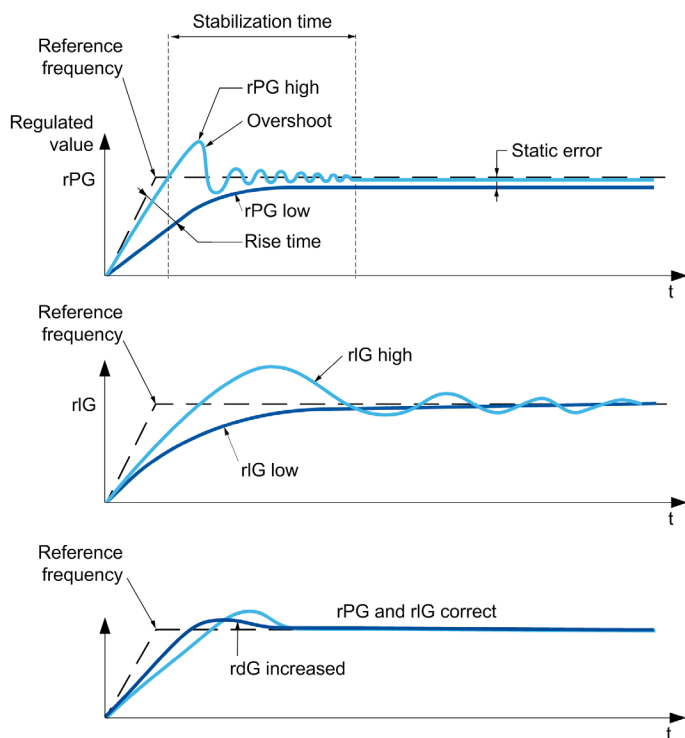

The oscillation frequency depends on the system kinematics:

Parameter	Rise time	Overshoot	Stabilization time	Static error
rPG +	- -	+	=	-
rIG +	-	+ +	+	- -
rdG +	=	-	-	=



## [PID Feedback] *F d b* - Menu

### Access

[Complete settings] → [Generic functions] → [PID controller] → [Feedback]

### About This Menu

**NOTE:** This function cannot be used with some other functions.

### [Type of Control] *t o C t*

Type of control for the PID = unit choice.

Setting	Code / Value	Description
[nA]	<i>n A</i>	No units <b>Factory setting</b>
[Pressure]	<i>P r E S S</i>	Pressure control and unit
[Flow]	<i>F L o W</i>	Flow control and unit
[Other]	<i>o t h E r</i>	Other control and unit (%)

### [PID Feedback] *P , F*

PID controller feedback.

Setting	Code / Value	Description
[No]	<i>n o</i>	Not assigned <b>Factory setting</b>
[AI1]...[AI3]	<i>A , 1...A , 3</i>	Analog input AI1...AI3
[AI4]...[AI5]	<i>A , 4...A , 5</i>	Analog input AI4...AI5 if VW3A3203 I/O extension module has been inserted
[AI Virtual 1]	<i>A , V 1</i>	Virtual analogic input 1
[PulseInput Assignment On DI5]...[PulseInput Assignment On DI6]	<i>P , 5...P , 6</i>	Digital input DI5...DI6 used as pulse input

### [AI1 Type] *A , I t* ★

Configuration of analog input AI1.

This parameter can be accessed if [PID Feedback] *P , F* is set to [AI1] *A , 1*.

Setting	Code / Value	Description
[Voltage]	<i>V o l t</i>	0-10 Vdc <b>Factory setting</b>
[Current]	<i>C u r</i>	0-20 mA

### [AI1 min value] *u , L I* ★

AI1 voltage scaling parameter of 0%.

This parameter can be accessed if:

- [PID Feedback] *P , F* is set to [AI1] *A , 1*, and
- [AI1 Type] *A , I t* is set to [Voltage] *V o l t*.

Setting	Description
0.0...10.0 Vdc	Setting range <b>Factory setting:</b> 0.0 Vdc

**[AI1 max value]  $\cup, H, I$  ★**

AI1 voltage scaling parameter of 100%.

This parameter can be accessed if:

- **[PID Feedback]  $P, F$**  is set to **[AI1]  $R, I$** , and
- **[AI1 Type]  $R, I, E$**  is set to **[Voltage]  $I, O, \cup$** .

Setting	Description
0.0...10.0 Vdc	Setting range <b>Factory setting:</b> 10.0 Vdc

**[AI1 min. value]  $\cap, R, L, I$  ★**

AI1 current scaling parameter of 0%.

This parameter can be accessed if:

- **[PID Feedback]  $P, F$**  is set to **[AI1]  $R, I$** , and
- **[AI1 Type]  $R, I, E$**  is set to **[Current]  $O, R$** .

Setting	Description
0.0...20.0 mA	Setting range <b>Factory setting:</b> 0.0 mA

**[AI1 max. value]  $\cap, R, H, I$  ★**

AI1 current scaling parameter of 100%.

This parameter can be accessed if:

- **[PID Feedback]  $P, F$**  is set to **[AI1]  $R, I$** , and
- **[AI Type]  $R, I, E$**  is set to **[Current]  $O, R$** .

Setting	Description
0.0...20.0 mA	Setting range <b>Factory setting:</b> 20.0 mA

**[AI2 Type]  $R, I, E$  ★**

Configuration of analog input AI2.

This parameter can be accessed if **[PID Feedback]  $P, F$**  is set to **[AI2]  $R, I, E$**

Setting	Code / Value	Description
<b>[Voltage]</b>	$I, O, \cup$	0-10 Vdc
<b>[Current]</b>	$O, R$	0-20 mA <b>Factory setting</b>
<b>[KTY]</b>	$K, E, Y$	1 KTY84 This selection can be accessed if <b>[Alx Th Monitoring] <math>E, H, X, S</math></b> is not set to <b>[No] <math>n, o</math></b>
<b>[PT1000]</b>	$I, P, E, 3$	1 PT1000 connected with 2 wires This selection can be accessed if <b>[Alx Th Monitoring] <math>E, H, X, S</math></b> is not set to <b>[No] <math>n, o</math></b>
<b>[PT100]</b>	$I, P, E, 2$	1 PT100 connected with 2 wires This selection can be accessed if <b>[Alx Th Monitoring] <math>E, H, X, S</math></b> is not set to <b>[No] <math>n, o</math></b>
<b>[3PT1000]</b>	$3, P, E, 3$	3 PT1000 connected with 2 wires This selection can be accessed if <b>[Alx Th Monitoring] <math>E, H, X, S</math></b> is not set to <b>[No] <math>n, o</math></b>
<b>[3PT100]</b>	$3, P, E, 2$	3 PT100 connected with 2 wires This selection can be accessed if <b>[Alx Th Monitoring] <math>E, H, X, S</math></b> is not set to <b>[No] <math>n, o</math></b>

**[AI2 min value]  $\mu, L 2$  ★**

AI2 voltage scaling parameter of 0%.

This parameter can be accessed if:

- **[PID Feedback]  $P, F$**  is set to **[AI2]  $R, 2$** , and
- **[AI2 Type]  $R, 2 E$**  is set to **[Voltage]  $10 \mu$** .

Identical to **[AI1 min value]  $\mu, L 1$**  (see page 177).

**[AI2 max value]  $\mu, H 2$  ★**

AI2 voltage scaling parameter of 100%.

This parameter can be accessed if:

- **[PID Feedback]  $P, F$**  is set to **[AI2]  $R, 2$** , and
- **[AI2 Type]  $R, 2 E$**  is set to **[Voltage]  $10 \mu$** .

Identical to **[AI1 max value]  $\mu, H 1$**  (see page 178).

**[AI2 min. value]  $C, r, L 2$  ★**

AI2 current scaling parameter of 0%.

This parameter can be accessed if:

- **[PID Feedback]  $P, F$**  is set to **[AI2]  $R, 2$** , and
- **[AI2 Type]  $R, 2 E$**  is set to **[Current]  $0 A$** .

Identical to **[AI1 min. value]  $C, r, L 1$**  (see page 178) with factory setting: 0.4 mA.

**[AI2 max. value]  $C, r, H 2$  ★**

AI2 current scaling parameter of 100%.

This parameter can be accessed if:

- **[PID Feedback]  $P, F$**  is set to **[AI2]  $R, 2$** , and
- **[AI2 Type]  $R, 2 E$**  is set to **[Current]  $0 A$** .

Identical to **[AI1 max. value]  $C, r, H 1$**  (see page 178).

**[AI3 Type]  $R, 3 E$  ★**

Configuration of analog input AI3.

This parameter can be accessed if **[PID Feedback]  $P, F$**  is set to **[AI3]  $R, 3$** .

Identical to **[AI2 Type]  $R, 2 E$** .

**[AI3 min value]  $\mu, L 3$  ★**

AI3 voltage scaling parameter of 0%.

This parameter can be accessed if:

- **[PID Feedback]  $P, F$**  is set to **[AI3]  $R, 3$** , and
- **[AI3 Type]  $R, 3 E$**  is set to **[Voltage]  $10 \mu$** .

Identical to **[AI1 min value]  $\mu, L 1$**  (see page 177).

**[AI3 max value]  $\mu, H 3$  ★**

AI3 voltage scaling parameter of 100%.

This parameter can be accessed if:

- **[PID Feedback]  $P, F$**  is set to **[AI3]  $R, 3$** , and
- **[AI3 Type]  $R, 3 E$**  is set to **[Voltage]  $10 \mu$** .

Identical to **[AI1 max value]  $\mu, H 1$**  (see page 178).

**[AI3 min. value] C r L 3 ★**

AI3 current scaling parameter of 0%.

This parameter can be accessed if:

- **[PID Feedback] P , F** is set to **[AI3] R , 3**, and
- **[AI3 Type] R , 3 E** is set to **[Current] 0 R**.

Identical to **[AI1 min. value] C r L 1** (see page 178).

**[AI3 max. value] C r H 3 ★**

AI3 current scaling parameter of 100%.

This parameter can be accessed if:

- **[PID Feedback] P , F** is set to **[AI3] R , 3**, and
- **[AI3 Type] R , 3 E** is set to **[Current] 0 R**.

Identical to **[AI1 max. value] C r H 1** (see page 178).

**[AI4 Type] R , 4 E ★**

Configuration of analog input AI4.

This parameter can be accessed if:

- VW3A3203 I/O extension module has been inserted, and
- **[PID Feedback] P , F** is set to **[AI4] R , 4**.

Setting	Code / Value	Description
<b>[Voltage]</b>	<b>1 0 u</b>	0-10 Vdc
<b>[Current]</b>	<b>0 R</b>	0-20 mA <b>Factory setting</b>
<b>[Voltage +/-]</b>	<b>n 1 0 u</b>	-10/+10 Vdc

**[AI4 min value] u , L 4 ★**

AI4 voltage scaling parameter of 0%.

This parameter can be accessed if:

- **[PID Feedback] P , F** is set to **[AI4] R , 4**, and
- **[AI4 Type] R , 4 E** is set to **[Voltage] 1 0 u**.

Identical to **[AI1 min value] u , L 1** (see page 177).

**[AI4 max value] u , H 4 ★**

AI4 voltage scaling parameter of 100%.

This parameter can be accessed if:

- **[PID Feedback] P , F** is set to **[AI4] R , 4**, and
- **[AI4 Type] R , 4 E** is set to **[Voltage] 1 0 u**.

Identical to **[AI1 max value] u , H 1** (see page 178).

**[AI4 min. value] C r L 4 ★**

AI4 current scaling parameter of 0%.

This parameter can be accessed if:

- **[PID Feedback] P , F** is set to **[AI4] R , 4**, and
- **[AI4 Type] R , 4 E** is set to **[Current] 0 R**.

Identical to **[AI1 min. value] C r L 1** (see page 178).

**[AI4 max. value] C r H 4 ★**

AI4 current scaling parameter of 100%.

This parameter can be accessed if:

- **[PID Feedback] P , F** is set to **[AI4] R , 4**, and
- **[AI4 Type] R , 4 E** is set to **[Current] D R**.

Identical to **[AI1 max. value] C r H 1** (*see page 178*).

**[AI5 Type] R , 5 E ★**

Configuration of analog input AI5.

This parameter can be accessed if:

- VW3A3203 I/O extension module has been inserted, and
- **[PID Feedback] P , F** is set to **[AI5] R , 5**.

Identical to **[AI4 Type] R , 4 E**.

**[AI5 min value] u , L 5 ★**

AI5 voltage scaling parameter of 0%.

This parameter can be accessed if:

- **[PID Feedback] P , F** is set to **[AI5] R , 5**, and
- **[AI4 Type] R , 5 E** is set to **[Voltage] I D u**.

Identical to **[AI1 min value] u , L 1** (*see page 177*).

**[AI5 max value] u , H 5 ★**

AI5 voltage scaling parameter of 100%.

This parameter can be accessed if:

- **[PID Feedback] P , F** is set to **[AI5] R , 5**, and
- **[AI4 Type] R , 5 E** is set to **[Voltage] I D u**.

Identical to **[AI1 max value] u , H 1** (*see page 178*).

**[AI5 min. value] C r L 5 ★**

AI5 current scaling parameter of 0%.

This parameter can be accessed if:

- **[PID Feedback] P , F** is set to **[AI5] R , 5**, and
- **[AI5 Type] R , 5 E** is set to **[Current] D R**.

Identical to **[AI1 min. value] C r L 1** (*see page 178*).

**[AI5 max. value] C r H 5 ★**

AI5 current scaling parameter of 100%.

This parameter can be accessed if:

- **[PID Feedback] P , F** is set to **[AI5] R , 5**, and
- **[AI5 Type] R , 5 E** is set to **[Current] D R**.

Identical to **[AI1 max. value] C r H 1** (*see page 178*).

**[Min PID feedback] P , F 1 ★**

Minimum PID feedback.

This parameter can be accessed if **[PID Feedback] P , F** is not set to **[Not Configured] n o**.

Setting ( )	Description
0... <b>[Max PID feedback] P , F 2</b>	Setting range Factory setting: 100

**[Max PID feedback] P , F 2 ★**

Maximum PID feedback.

This parameter can be accessed if **[PID Feedback] P , F** is not set to **[Not Configured] n a**.

Setting ( )	Description
<b>[Min PID feedback] P , F 1...32,767</b>	Setting range <b>Factory setting:</b> 1,000

**[PID feedback] r P F ★**

Value for PID feedback, display only.

This parameter can be accessed if **[PID Feedback] P , F** is not set to **[Not Configured] n a**.

Setting	Description
0...65,535	Setting range <b>Factory setting:</b> 0

**[Min Fbk Warning] P F L ★**

Minimum feedback level warning (for **[PID Low Fdbck Warn] P F F L** warning).

This parameter can be accessed if **[PID Feedback] P , F** is not set to **[Not Configured] n a**.

Setting ( )	Description
0...65,535	Setting range <b>Factory setting:</b> 100

**[Max Fbk Warning] P F H ★**

Maximum feedback level warning (for **[PID High Fdbck Warn] P F F H** warning).

This parameter can be accessed if **[PID Feedback] P , F** is not set to **[Not Configured] n a**.

Setting ( )	Description
0...65,535	Setting range <b>Factory setting:</b> 1,000

## [PID Reference] $r F$ - Menu

### Access

[Complete settings] → [Generic functions] → [PID controller] → [PID Reference]

### About This Menu

**NOTE:** This function cannot be used with some other functions.

### [Intern PID Ref] $P_{II}$ ★

Internal PID reference.

This parameter can be accessed if [PID Feedback]  $P_{IF}$  is not set to [Not Configured]  $n o$ .

Setting	Code / Value	Description
[No]	$n o$	The PID controller reference is given by [Ref Freq 1 Config] $F_{r1}$ . <b>Factory setting</b>
[Yes]	$y e s$	The PID controller reference is internal via [Internal PID ref] $r P_{II}$ .

### [Ref Freq 1 Config] $F_{r1}$ ★

Configuration reference frequency 1.

This parameter can be accessed if:

- [PID Feedback]  $P_{IF}$  is not set to [Not Configured]  $n o$ , and
- [Intern PID Ref]  $P_{II}$  is set to [No]  $n o$ .

Setting	Code / Value	Description
[Not Configured]	$n o$	Not assigned
[AI1]	$A_{I1}$	Analog input AI1 <b>Factory Setting</b>
[AI2]...[AI3]	$A_{I2}...A_{I3}$	Analog input AI2...AI3
[AI Virtual 1]	$A_{IV1}$	Virtual analogic input 1
[AI4]...[AI5]	$A_{I4}...A_{I5}$	Analog input AI4...AI5 if VW3A3203 I/O extension module has been inserted
[Ref.Freq-Rmt.Term]	$L C C$	Reference Frequency via remote terminal
[Ref. Freq-Modbus]	$M d b$	Reference frequency via Modbus
[Ref. Freq-Com. Module]	$n E k$	Reference frequency via fieldbus module if a fieldbus module has been inserted
[DI5 PulseInput Assignment]...[DI6 PulseInput Assignment]	$P_{I5}...P_{I6}$	Digital input DI5...DI6 used as pulse input

### [Min PID reference] $P_{IP1}$ ★

Minimum PID reference.

This parameter can be accessed if [PID Feedback]  $P_{IF}$  is not set to [Not Configured]  $n o$ .

Setting ( )	Description
[Min PID feedback] $P_{IF1}$ ...[Max PID reference] $P_{IP2}$	Setting range <b>Factory setting:</b> 150

**[Max PID reference] P, P2 ★**

Maximum PID reference.

This parameter can be accessed if **[PID Feedback] P, F** is not set to **[Not Configured] n o**.

Setting ( )	Description
<b>[Min PID reference] P, P 1...[Max PID feedback] P, F 2</b>	Setting range <b>Factory setting:</b> 900

**[Internal PID ref] r P, ★**

Internal PID reference.

This parameter can be accessed if:

- **[PID Feedback] P, F** is not set to **[Not Configured] n o**, and
- **[Intern PID Ref] P, r** is set to **[Yes] Y E 5**.

Setting ( )	Description
<b>[Min PID reference] P, P 1...[Max PID reference] P, P 2</b>	Setting range <b>Factory setting:</b> 150

**[Auto/Manual assign.] P R u ★**

Auto/Manual select input.

This parameter can be accessed if **[PID Feedback] P, F** is not set to **[Not Configured] n o**.

Setting	Code / Value	Description
<b>[Not Assigned]</b>	<b>n o</b>	Not assigned <b>Factory setting</b>
<b>[DI1]...[DI6]</b>	<b>L, I...L, 6</b>	Digital input DI1...DI6
<b>[DI11]...[DI16]</b>	<b>L, I I I...L, 16</b>	Digital input DI11...DI16 if VW3A3203 I/O extension module has been inserted
<b>[CD00]...[CD10]</b>	<b>C d 0 0...C d 1 0</b>	Virtual digital input CMD.0...CMD.10 in <b>[I/O profile] , o</b> configuration
<b>[CD11]...[CD15]</b>	<b>C d 1 1...C d 1 5</b>	Virtual digital input CMD.11...CMD.15 in <b>[I/O profile] , o</b> configuration
<b>[C101]...[C110]</b>	<b>C 1 0 1...C 1 1 0</b>	Virtual digital input CMD1.01...CMD1.10 with integrated Modbus Serial in <b>[I/O profile] , o</b> configuration
<b>[C111]...[C115]</b>	<b>C 1 1 1...C 1 1 5</b>	Virtual digital input CMD1.11...CMD1.15 with integrated Modbus Serial in <b>[I/O profile] , o</b> configuration
<b>[C301]...[C310]</b>	<b>C 3 0 1...C 3 1 0</b>	Virtual digital input CMD3.01...CMD3.10 with a fieldbus module in <b>[I/O profile] , o</b> configuration
<b>[C311]...[C315]</b>	<b>C 3 1 1...C 3 1 5</b>	Virtual digital input CMD3.11...CMD3.15 with a fieldbus module in <b>[I/O profile] , o</b> configuration



**[Manual PID Reference] P, 7 ★**

Manual PID reference.

Reference input in manual mode.

This parameter can be accessed if:

- **[PID Feedback] P, F** is not set to **[Not Configured] n o**, and
- **[Auto/Manual assign.] P A u** is not set to **[No] n o**.

The preset speeds are active on the manual reference if they have been configured.

Setting	Code / Value	Description
[No]	n o	Not assigned <b>Factory setting</b>
[AI1]...[AI3]	A , 1...A , 3	Analog input AI1...AI3
[AI4]...[AI5]	A , 4...A , 5	Analog input AI4...AI5 if VW3A3203 I/O extension module has been inserted
[PulseInput Assignment On DI5]...[PulseInput Assignment On DI6]	P , 5...P , 6	Digital input DI5...DI6 used as pulse input

## [PID preset references] P r , - Menu

### Access

[Complete settings] → [Generic functions] → [PID controller] → [Reference frequency] → [PID preset references]

### About This Menu

The function can be accessed if [PID feedback Assign] P , F is assigned.

### [2 PID Preset Assign] P r 2

2 PID Preset assignment.

If the assigned input or bit is at 0, the function is inactive.

If the assigned input or bit is at 1, the function is active.

Setting	Code / Value	Description
[Not Assigned]	n o	Not assigned <b>Factory setting</b>
[DI1]...[DI6]	L , I...L , 6	Digital input DI1...DI6
[DI11]...[DI16]	L , I I...L , 16	Digital input DI11...DI16 if VW3A3203 I/O extension module has been inserted
[CD00]...[CD10]	C d 0 0...C d 1 0	Virtual digital input CMD.0...CMD.10 in [I/O profile] , o configuration
[CD11]...[CD15]	C d 1 1...C d 1 5	Virtual digital input CMD.11...CMD.15 in [I/O profile] , o configuration
[C101]...[C110]	C 1 0 1...C 1 1 0	Virtual digital input CMD1.01...CMD1.10 with integrated Modbus Serial in [I/O profile] , o configuration
[C111]...[C115]	C 1 1 1...C 1 1 5	Virtual digital input CMD1.11...CMD1.15 with integrated Modbus Serial in [I/O profile] , o configuration
[C301]...[C310]	C 3 0 1...C 3 1 0	Virtual digital input CMD3.01...CMD3.10 with a fieldbus module in [I/O profile] , o configuration
[C311]...[C315]	C 3 1 1...C 3 1 5	Virtual digital input CMD3.11...CMD3.15 with a fieldbus module in [I/O profile] , o configuration

### [4 PID Preset Assign] P r 4

4 PID Preset assignment.

Identical to [2 PID Preset Assign] P r 2 (see page 186).

Verify that [2 PID Preset Assign] P r 2 has been assigned before assigning this function.

### [Ref PID Preset 2] r P 2 ★

Second PID preset reference.

This parameter can be accessed only if [2 PID Preset Assign] P r 2 is assigned.

Setting ( )	Description
[Min PID reference] P , P 1...[Max PID reference] P , P 2	Setting range <b>Factory setting:</b> 300

### [Ref PID Preset 3] r P 3 ★

Third PID preset reference.

This parameter can be accessed only if [4 PID Preset Assign] P r 4 is assigned.

Setting ( )	Description
[Min PID reference] P , P 1...[Max PID reference] P , P 2	Setting range <b>Factory setting:</b> 600

**[Ref PID Preset 4]  $r_{P4}$  ★**

Fourth PID preset reference.

This parameter can be accessed only if **[4 PID Preset Assign]  $P_r 4$**  and **[2 PID Preset Assign]  $P_r 2$**  are assigned.

Setting ( )	Description
<b>[Min PID reference] <math>P_{r1}</math>...[Max PID reference] <math>P_{r2}</math></b>	Setting range Factory setting: 900

**[PID Reference]  $r F$  - Menu****Access**

[Complete settings] → [Generic functions] → [PID controller] → [PID Reference]

**[Predictive Speed Ref]  $F P$  , ★**

Predictive speed reference.

This parameter can be accessed if [Access Level]  $L R C$  is set to [Expert]  $E P r$ .

Setting	Code / Value	Description
[No]	$n o$	Not assigned <b>Factory setting</b>
[AI1]...[AI3]	$R , 1 \dots R , 3$	Analog input AI1...AI3
[AI4]...[AI5]	$R , 4 \dots R , 5$	Analog input AI4...AI5 if VW3A3203 I/O extension module has been inserted
[Ref.Freq-Rmt.Term]	$L C C$	Reference frequency via remote terminal
[Ref. Freq-Modbus]	$M d b$	Reference frequency via Modbus
[Ref. Freq-Com. Module]	$n E t$	Reference frequency via communication module
[PulseInput Assignment On DI5]...[PulseInput Assignment On DI6]	$P , 5 \dots P , 6$	Digital input DI5...DI6 used as pulse input

**[Speed Input %]  $P S r$  ★**

PID speed input % reference.

This parameter can be accessed if [Access Level]  $L R C$  is set to [Expert]  $E P r$ .

Setting ( )	Description
1...100%	Setting range <b>Factory setting:</b> 100%

## [Settings] 5 L - Menu

### Access

[Complete settings] → [Generic functions] → [PID controller] → [Settings]

### About This Menu

Following parameters can be accessed if [PID Feedback]  $P_i F$  is not set to [Not Configured]  $n o$ .

**NOTE:** This function cannot be used with some other functions.

### [PID Prop.Gain] $P_G$ ★

PID proportional gain.

Setting ( )	Description
0.01...100.00	Setting range <b>Factory setting:</b> 1.00

### [PI Intgl.Gain] $I_G$ ★

Integral gain.

Setting ( )	Description
0.01...100.00	Setting range <b>Factory setting:</b> 1.00

### [PID derivative gain] $D_G$ ★

Derivative gain.

Setting ( )	Description
0.00...100.00	Setting range <b>Factory setting:</b> 0.00

### [PID ramp] $P_r P$ ★

PID acceleration/deceleration ramp, defined to go from [Min PID reference]  $P_i P_1$  to [Max PID reference]  $P_i P_2$  and conversely.

Setting ( )	Description
0.0...99.9 s	Setting range <b>Factory setting:</b> 0.0 s

### [PID Inversion] $P_i I$ ★

PID inversion.

Setting	Code / Value	Description
[No]	$n o$	No <b>Factory setting</b>
[Yes]	$Y E S$	Yes

### [PID Min Output] $P_o L$ ★

PID controller minimum output in Hz.

Setting ( )	Description
-500.0...500.0 Hz	Setting range <b>Factory setting:</b> 0.0 Hz

**[PID Max Output] P<sub>o</sub>H** ★

PID controller maximum output in Hz.

Setting ( )	Description
0.0...500.0 Hz	Setting range <b>Factory setting:</b> 60.0 Hz

**[PID Error Warning] PEr** ★

PID error warning.

Setting ( )	Description
0...65,535	Setting range <b>Factory setting:</b> 100

**[PID Integral OFF] P<sub>i</sub>S** ★

Integral shunt.

If the assigned input or bit is at 0, the function is inactive (the PID integral is enabled).

If the assigned input or bit is at 1, the function is active (the PID integral is disabled).

Setting	Code / Value	Description
[Not Assigned]	n a	Not assigned <b>Factory setting</b>
[DI1]...[DI6]	L , I...L , 6	Digital input DI1...DI6
[DI11]...[DI16]	L , I I...L , 16	Digital input DI11...DI16 if VW3A3203 I/O extension module has been inserted
[CD00]...[CD10]	C d 0 0...C d 1 0	Virtual digital input CMD.0...CMD.10 in <b>[I/O profile]</b> , a configuration
[CD11]...[CD15]	C d 1 1...C d 1 5	Virtual digital input CMD.11...CMD.15 in <b>[I/O profile]</b> , a configuration
[C101]...[C110]	C 1 0 1...C 1 1 0	Virtual digital input CMD1.01...CMD1.10 with integrated Modbus Serial in <b>[I/O profile]</b> , a configuration
[C111]...[C115]	C 1 1 1...C 1 1 5	Virtual digital input CMD1.11...CMD1.15 with integrated Modbus Serial in <b>[I/O profile]</b> , a configuration
[C301]...[C310]	C 3 0 1...C 3 1 0	Virtual digital input CMD3.01...CMD3.10 with a fieldbus module in <b>[I/O profile]</b> , a configuration
[C311]...[C315]	C 3 1 1...C 3 1 5	Virtual digital input CMD3.11...CMD3.15 with a fieldbus module in <b>[I/O profile]</b> , a configuration

**[PID acceleration time] ACCP ★**

PID: acceleration during start-up.

PID start ramp can be applied before starting the PID controller to allow reaching quickly the PID reference without increasing PID gains.

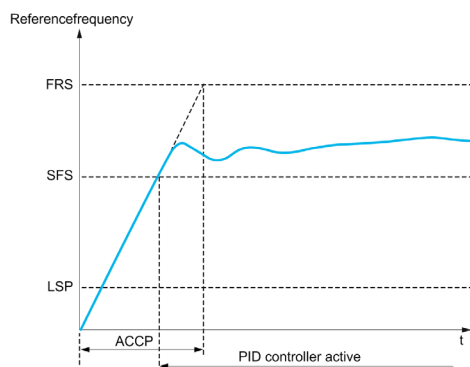

Setting ( )	Description
0.01...99,99 s	Setting range Factory setting: 5.00 s
(1) Range 0.01 to 99.99 s or 0.1 to 999.9 s or 1 to 6,000 according to [Ramp increment] <i>inc</i>	

**[PID Start Ref Freq] SF5 ★**

PID start reference frequency.

Setting ( )	Description
0.0...500.0 Hz	Setting range If [PID Start Ref Freq] SF5 is lower than [Low speed] LSP, this function has no effect. Factory setting: 0.0 Hz

## Section 6.13

### [Generic functions] - [Sleep/wakeup] *5 Pw* - Menu

#### What Is in This Section?

This section contains the following topics:

Topic	Page
[Sleep/Wakeup] <i>5 Pw</i> - Overview	193
[Sleep menu] <i>5 L P</i> - Menu	197
[AI1 Sensor config.] <i>5 , F 1</i> - Menu	199
[AI2 Sensor config.] <i>5 , F 2</i> - Menu	201
[AI3 Sensor config.] <i>5 , F 3</i> - Menu	203
[AI4 Sensor config.] <i>5 , F 4</i> - Menu	204
[AI5 Sensor config.] <i>5 , F 5</i> - Menu	205
[DI5 Sensor Configuration] <i>5 , F B</i> - Menu	206
[DI6 Sensor Configuration] <i>5 , F 9</i> - Menu	207
[AIV1 Sensor config.] <i>5 , V 1</i> - Menu	208
[Sleep menu] <i>5 L P</i> - Menu	209
[Boost] <i>5 b t</i> - Menu	211
[Advanced sleep check] <i>R d 5</i> - Menu	212
[Wake up menu] <i>wk P</i> - Menu	215



## [Sleep/Wakeup] *S P W* - Overview

### About This Menu

Following parameters can be accessed if [PID feedback Assign] *P I F* is not set to [Not Configured] *n o*.

### WARNING

#### UNANTICIPATED EQUIPMENT OPERATION

Verify that activating this function does not result in unsafe conditions.

**Failure to follow these instructions can result in death, serious injury, or equipment damage.**

The purpose of the "Sleep / Wake-Up" function is to stop the motor in process standstill situations.

It allows you to save energy and helps to prevent premature aging of some equipment that cannot run for a long time at low speed because the greasing or cooling depends on the machine speed.

In a pressure-controlled pumping application:

- The purpose of the Sleep / Wake-Up function is to manage periods of the application where the water demand is low and where it is not needed to keep the main pumps running.
- It allows you to save energy in low demand periods. Then, when the demand is increasing, the application needs to wake up in order to meet the demand.
- Optionally, during a sleep period, a Jockey pump can be started to maintain an emergency service pressure or meet a low water demand.

Depending on user-defined wakeup conditions, the motor is restarted automatically.

### Sleep/Wake-Up in PID Control Mode

When the drive is used in PID control, one of the following conditions is used to switch the application to the sleep state:

- Sleep on low speed (when all fixed pumps are Off in case of a multi-pump application).
- Sleep on low sleep sensor value (using flow sensor for monitoring).
- Sleep on low motor power (when all fixed pumps are Off in case of a multi-pump application).
- Sleep on external condition (using drive input).

The drive is in "PID control mode" when PID is active. Typically when:

- PID is configured, and
- Channel 1 is selected, and
- PID is in automatic mode.

When the drive is in a sleep state, a wake-up condition is used to restart the application:

- Wake-up on PID Feedback level
- Wake-up on PID Error level
- Wake-up on low-pressure condition

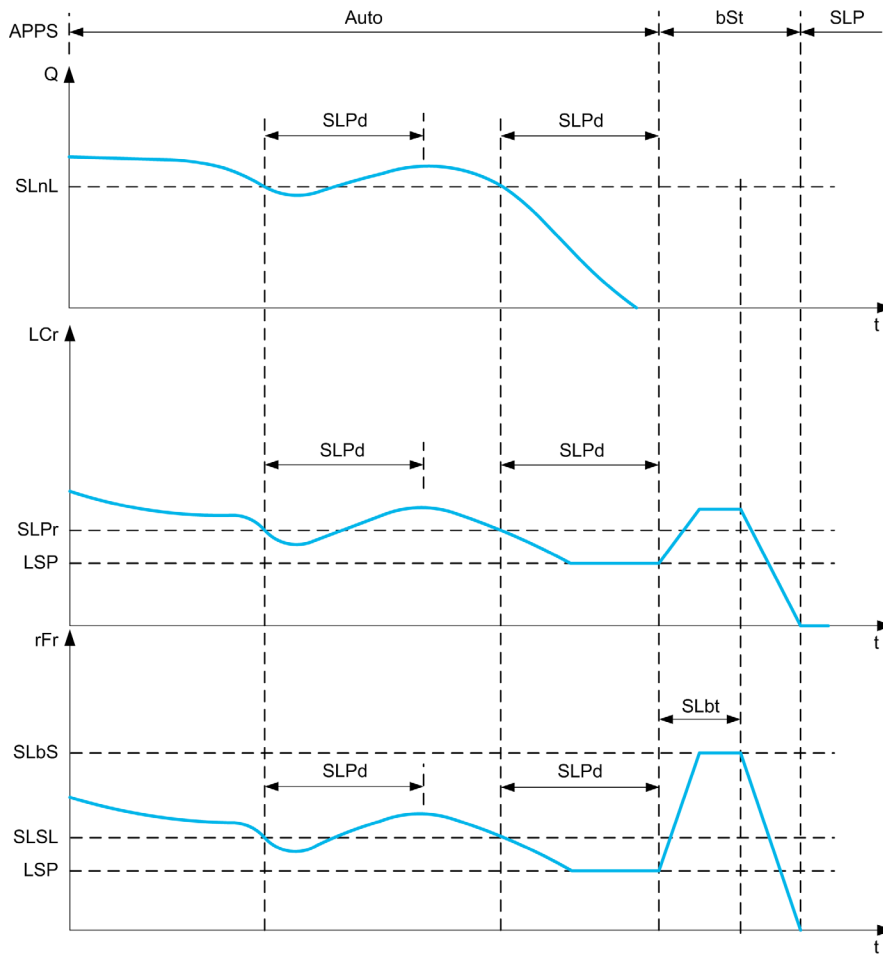

### Sleep Conditions in PID Control Mode

If there is no valid wake-up condition, then the system switches to the sleep mode after one of the configured sleep conditions remains longer than **[Sleep Delay] 5 L P d**.

The sleep detection mode is selected by configuring **[Sleep Detect Mode] 5 L P n**. Then the system switches to sleep mode if the selected condition is met:

Configuration	Condition
<b>L F</b> sleep on flow sensor value	Sensor value is below the sleep level
<b>5 W</b> sleep on switch or external condition	The switch input becomes active
<b>5 P d</b> sleep on speed	The output frequency is below the sleep speed
<b>P W r</b> sleep on power level	The output power is below the sleep power
<b>H P</b> sleep on pressure sensor value	Sensor value is higher than the sleep level
<b>a r</b> multiple conditions	At least 1 of the configured condition to enter in sleep mode is met

### Wake-Up Conditions in PID Control Mode

The system wakes up according to **[Wake Up Mode] W u P n** configuration:

- On PID Feedback level
- On PID Error level.
- On low-pressure condition.

The system wakes up if the wake up conditions are valid for a time longer than the **[Wake Up Delay] W u P d**.

If **[Feedback] F b k** is selected, then the system wakes up and goes back in PID control mode:

- When PID feedback drops below configured **[Wake Up Process Level] W u P F** if PID is configured in Direct mode, (**[PID Inversion] P i C** is set to **n a**).
- When PID feedback raises above configured **[Wake Up Process Level] W u P F**, if PID is configured in Reverse mode (**[PID Inversion] P i C** is set to **Y E S**).

If **[Error] E r r** is selected, then the system wakes up and goes back in PID control mode:

- When PID feedback drops below (**[PID reference] r P C** - **[Wake Up Process Error] W u P E**), if PID is configured in Direct mode (**[PID Inversion] P i C** is set to **n a**).
- When PID feedback raises above (**[PID reference] r P C** + **[Wake Up Process Error] W u P E**), if PID is configured in Reverse mode (**[PID Inversion] P i C** is set to **Y E S**).

If **[Pressure] L P** is selected, then the system wakes up and goes back in PID control mode when the pressure feedback drops below **[Wake Up Process Level] W u P F**.

### Boosting Phase in PID Control Mode

When entering the sleep mode, the motor accelerates to **[Sleep Boost Speed] 5 L b S** during **[Sleep Boost Time] 5 L b t** and then stops.

If **[Sleep Boost Time] 5 L b t** is set to 0, then the boost phase is ignored.

### Initial State in PID Control Mode

Just after the system starts in automatic mode (a run order appears while in automatic mode - channel 1 already selected and PID auto):

- If a wake-up condition is met, the drive goes in PID control mode (PID started).
- If a wake-up condition is not met, the drive goes in sleep mode (PID stays stopped and motor is kept halted), and Boosting phase is ignored.

When the control is switched to automatic mode while the motor is running (switch to channel 1 or switch to PID auto mode for example), the drive stays in running state and switches to PID automatic mode.

### Configuration of Sleep External Condition (Usage of a No Flow Switch for Example)

Sleep switch allows you to select the source of sleep external condition:

- **n a**: no input selected for the sleep external condition.
- **d i X**: the sleep external condition (switch for example) is connected to DIx (the assignment is also possible on a control bit in I/O profile).

### Configuration of Sleep Sensor (Flow or Pressure Sensor)

The assignment of a sleep sensor, the configuration of the selected physical input and the configuration of scaling to process value are performed.

A sleep sensor source is selected by **[Inst. Flow Assign.] F 5 I R** and **[OutletPres Assign] P 5 Z R** which allows to select the analog or pulse input on which the sensor is connected:

- **n a**: no input selected for sleep sensor value.
- **R , X**: sleep sensor is connected to AIx.
- **R , v X**: sleep sensor is connected to virtual AIUx.
- **P , X**: sleep sensor is connected to pulse input PIx.

The configuration of an analog input is performed.

The configuration of a pulse input is performed.

Depending on the selected source, the process range of the sensor is configured by:

- **[AIx Lowest Process] R , X J**, **[AIx Highest Process] R , X K** (without unit), when connected on an analog input.
- **[AIv1 Lowest Process] R V , J**, **[AIv1 Highest Process] R V , K** (without unit), when using the virtual analog input.
- **[DIx PulseInput Low Freq] P , L X**, **[DIx PulseInput High Freq] P , H X** (without unit), when connected on a pulse input configured in frequency.

## [Sleep menu] *S L P* - Menu

### Access

[Complete settings] → [Generic functions] → [Sleep/Wakeup] → [Sleep menu]

### About This Menu

#### [Sleep Detect Mode] *S L P Π*

Sleep detection mode.

Setting	Code / Value	Description
[No]	<i>n o</i>	Not configured <b>Factory setting</b>
[Switch]	<i>S W</i>	System enters in sleep mode on switch condition
[Flow]	<i>L F</i>	System enters in sleep mode on low flow condition
[Speed]	<i>S P d</i>	System enters in sleep mode on speed condition
[Power]	<i>P W r</i>	System enters in sleep mode on power condition
[Pressure]	<i>H P</i>	System enters in sleep mode on high-pressure condition
[Multiple]	<i>o r</i>	System enters in sleep mode on multiple-OR condition

#### [Sleep Switch Assign] *S L P W*

Sleep switch assignment.

This parameter can be accessed if [Sleep Detect Mode] *S L P Π* is set to [Switch] *S W* or [Multiple] *o r*.

Select an external condition to enter in sleep mode (for example, flow switch).

Setting	Code / Value	Description
[Not Assigned]	<i>n o</i>	Not assigned <b>Factory setting</b>
[DI1]...[DI6]	<i>L , I ... L , 6</i>	Digital input DI1...DI6
[DI11]...[DI16]	<i>L , I I ... L , 16</i>	Digital input DI11...DI16 if VW3A3203 I/O extension module has been inserted
[CD00]...[CD10]	<i>C d 0 0 ... C d 1 0</i>	Virtual digital input CMD.0...CMD.10 in [I/O profile] , <i>o</i> configuration
[CD11]...[CD15]	<i>C d 1 1 ... C d 1 5</i>	Virtual digital input CMD.11...CMD.15 regardless of configuration
[C101]...[C110]	<i>C 1 0 1 ... C 1 1 0</i>	Virtual digital input CMD1.01...CMD1.10 with integrated Modbus Serial in [I/O profile] , <i>o</i> configuration
[C111]...[C115]	<i>C 1 1 1 ... C 1 1 5</i>	Virtual digital input CMD1.11...CMD1.15 with integrated Modbus Serial regardless of configuration
[C301]...[C310]	<i>C 3 0 1 ... C 3 1 0</i>	Virtual digital input CMD3.01...CMD3.10 with a fieldbus module in [I/O profile] , <i>o</i> configuration
[C311]...[C315]	<i>C 3 1 1 ... C 3 1 5</i>	Virtual digital input CMD3.11...CMD3.15 with a fieldbus module regardless of configuration
[DI1 (Low level)]...[DI6 (Low level)]	<i>L , I L ... L , 6 L</i>	Digital input DI1...DI6 used at low level

**[Inst. Flow Assign.] F 5 I R** ★

Installation flow sensor assignment.

This parameter can be accessed if **[Sleep Detect Mode] S L P Π** is set to **[Flow] L F**, or **[Multiple] α r**.

Setting	Code / Value	Description
<b>[Not Configured]</b>	<i>n o</i>	Not assigned <b>Factory setting</b>
<b>[AI1]...[AI3]</b>	<i>R , 1...R , 3</i>	Analog input AI1...AI3
<b>[AI4]...[AI5]</b>	<i>R , 4...R , 5</i>	Analog input AI4...AI5 if VW3A3203 I/O extension module has been inserted
<b>[AI Virtual 1]</b>	<i>R , V 1</i>	Virtual analogic input 1
<b>[DI5 PulseInput Assignment]...[DI6 PulseInput Assignment]</b>	<i>P , 5...P , 6</i>	Digital input DI5...DI6 used as pulse input

## [AI1 Sensor config.] 5 , F I - Menu

### Access

[Complete settings] → [Generic functions] → [Sleep/wakeup] → [Sleep menu] → [AI1 Sensor config.]

### About This Menu

This menu can be accessed if:

- [Inst. Flow Assign.] F 5 I R is set to [AI1] R , I , and
- [Sleep Detect Mode] 5 L P N is set to
  - [Flow] L F , or
  - [Multiple] a r .

### [AI1 Type] R , I E

Configuration of analog input AI1.

Setting	Code / Value	Description
[Voltage]	I 0 u	0-10 Vdc Factory setting
[Current]	a R	0-20 mA

### [AI1 min value] u , L I ★

AI1 voltage scaling parameter of 0%.

This parameter can be accessed if [AI1 Type] R , I E is set to [Voltage] I 0 u.

Setting	Description
0.0...10.0 Vdc	Setting range Factory setting: 0.0 Vdc

### [AI1 max value] u , H I ★

AI1 voltage scaling parameter of 100%.

This parameter can be accessed if [AI1 Type] R , I E is set to [Voltage] I 0 u.

Setting	Description
0.0...10.0 Vdc	Setting range Factory setting: 10.0 Vdc

### [AI1 min. value] C r L I ★

AI1 current scaling parameter of 0%.

This parameter can be accessed if [AI1 Type] R , I E is set to [Current] a R.

Setting	Description
0.0...20.0 mA	Setting range Factory setting: 0.0 mA

### [AI1 max. value] C r H I ★

AI1 current scaling parameter of 100%.

This parameter can be accessed if [AI1 Type] R , I E is set to [Current] a R.

Setting	Description
0.0...20.0 mA	Setting range Factory setting: 20.0 mA

**[AI1 Lowest Process] # , I J**

AI1 lowest process.

Setting	Description
-32,768...32,767	Setting range. Value in application customer unit. <b>Factory setting:</b> 0

**[AI1 Highest Process] # , I K**

AI1 highest process.

Setting	Description
-32,768...32,767	Setting range. Value in application customer unit. <b>Factory setting:</b> 0



## [AI2 Sensor config.] 5 , F 2 - Menu

### Access

[Complete settings] → [Generic functions] → [Sleep/wakeup] → [Sleep menu] → [AI2 Sensor config.]

### About This Menu

This menu can be accessed if:

- [Inst. Flow Assign.] F 5 I R is set to [AI2] R , 2 , and
- [Sleep Detect Mode] 5 L P N is set to
  - [Flow] L F , or
  - [Multiple] o r .

### [AI2 Type] R , 2 E

Configuration of analog input AI2.

Setting	Code / Value	Description
[Voltage]	1 0 u	0-10 Vdc
[Current]	0 R	0-20 mA Factory setting
[KTY]	K E Y	1 KTY84 This selection can be accessed if [Alx Th Monitoring] E H X 5 is not set to [No] n o
[PT1000]	1 P E 3	1 PT1000 connected with 2 wires This selection can be accessed if [Alx Th Monitoring] E H X 5 is not set to [No] n o
[PT100]	1 P E 2	1 PT100 connected with 2 wires This selection can be accessed if [Alx Th Monitoring] E H X 5 is not set to [No] n o
[3PT1000]	3 P E 3	3 PT1000 connected with 2 wires This selection can be accessed if [Alx Th Monitoring] E H X 5 is not set to [No] n o
[3PT100]	3 P E 2	3 PT100 connected with 2 wires This selection can be accessed if [Alx Th Monitoring] E H X 5 is not set to [No] n o

### [AI2 min value] u , L 2 ★

AI2 voltage scaling parameter of 0%.

This parameter can be accessed if [AI2 Type] R , 2 E is set to [Voltage] 1 0 u.

Identical to [AI1 min value] u , L 1 (see page 199).

### [AI2 max value] u , H 2 ★

AI2 voltage scaling parameter of 100%.

This parameter can be accessed if [AI2 Type] R , 2 E is set to [Voltage] 1 0 u.

Identical to [AI1 max value] u , H 1 (see page 199).

### [AI2 min. value] C r L 2 ★

AI2 current scaling parameter of 0%.

This parameter can be accessed if [AI2 Type] R , 2 E is set to [Current] o R.

Identical to [AI1 min. value] C r L 1 (see page 199) with factory setting: 0.4 mA.

### [AI2 max. value] C r H 2 ★

AI2 current scaling parameter of 100%.

This parameter can be accessed if [AI2 Type] R , 2 E is set to [Current] o R.

Identical to [AI1 max. value] C r H 1 (see page 199).

**[AI2 Lowest Process] # , 2 J**

AI2 lowest process.

Identical to **[AI1 Lowest Process] # , 1 J** (*see page 200*).

**[AI2 Highest Process] # , 2 K**

AI2 highest process.

Identical to **[AI1 Highest Process] # , 1 K** (*see page 200*).

## [AI3 Sensor config.] 5 , F 3 - Menu

### Access

[Complete settings] → [Generic functions] → [Sleep/wakeup] → [Sleep menu] → [AI3 Sensor config.]

### About this menu

This menu can be accessed if:

- [Inst. Flow Assign.] F 5 I A is set to [AI3] A , 3 , and
- [Sleep Detect Mode] 5 L P N is set to
  - [Flow] L F , or
  - [Multiple] a r .

### [AI3 Type] A , 3 E

Configuration of analog input AI3.

Identical to [AI2 Type] A , 2 E (see page 201).

### [AI3 min value] u , L 3 ★

AI3 voltage scaling parameter of 0%.

This parameter can be accessed if A , 3 E is set to [Voltage] I 0 u .

Identical to [AI1 min value] u , L I (see page 199).

### [AI3 max value] u , H 3 ★

AI3 voltage scaling parameter of 100%.

This parameter can be accessed if A , 3 E is set to [Voltage] I 0 u .

Identical to [AI1 max value] u , H I (see page 199).

### [AI3 min. value] C r L 3 ★

AI3 current scaling parameter of 0%.

This parameter can be accessed if A , 3 E is set to [Current] a A .

Identical to [AI1 min. value] C r L I (see page 199).

### [AI3 max. value] C r H 3 ★

AI3 current scaling parameter of 100%.

This parameter can be accessed if A , 3 E is set to [Current] a A .

Identical to [AI1 max. value] C r H I (see page 199).

### [AI3 Lowest Process] A , 3 J

AI3 lowest process.

Identical to [AI1 Lowest Process] A , I J (see page 200).

### [AI3 Highest Process] A , 3 K

AI3 highest process.

Identical to [AI1 Highest Process] A , I K (see page 200).

## [AI4 Sensor config.] 5 , F 4 - Menu

### Access

[Complete settings] → [Pump functions] → [Sleep/wakeup] → [Sleep menu] → [AI4 Sensor config.]

### About This Menu

This menu can be accessed if:

- [Inst. Flow Assign.] F 5 I R is set to [AI4] R , 4, and
- [Sleep Detect Mode] 5 L P Π is set to
  - [Flow] L F, or
  - [Multiple] α r .

### [AI4 Type] R , 4 E ★

Configuration of analog input AI4.

This parameter can be accessed if VW3A3203 I/O extension module has been inserted.

Setting	Code / Value	Description
[Voltage]	1 0 μ	0-10 Vdc
[Current]	0 R	0-20 mA <b>Factory setting</b>
[Voltage +/-]	n 1 0 μ	-10/+10 Vdc

### [AI4 min value] μ , L 4 ★

AI4 voltage scaling parameter of 0%.

Identical to [AI1 min value] μ , L 1 (see page 199).

### [AI4 max value] μ , H 4 ★

AI4 voltage scaling parameter of 100%.

Identical to [AI1 max value] μ , H 1 (see page 199).

### [AI4 min. value] C r L 4 ★

AI4 current scaling parameter of 0%.

Identical to [AI1 min. value] C r L 1 (see page 199).

### [AI4 max. value] C r H 4 ★

AI4 current scaling parameter of 100%.

Identical to [AI1 max. value] C r H 1 (see page 199).

### [AI4 Lowest Process] R , 4 J

AI4 lowest process.

Identical to [AI1 Lowest Process] R , 1 J (see page 200).

### [AI4 Highest Process] R , 4 K

AI4 highest process.

Identical to [AI1 Highest Process] R , 1 K (see page 200).

## [AI5 Sensor config.] 5 , F 5 - Menu

### Access

[Complete settings] → [Generic functions] → [Sleep/wakeup] → [Sleep menu] → [AI5 Sensor config.]

### About This Menu

This menu can be accessed if:

- [Inst. Flow Assign.] F 5 I R is set to [AI5] R , 5 , and
- [Sleep Detect Mode] 5 L P Π is set to
  - [Flow] L F , or
  - [Multiple] □ r .

### [AI5 Type] R , 5 E ★

Configuration of analog input AI5.

This parameter can be accessed if VW3A3203 I/O extension module has been inserted.

Identical to [AI4 Type] R , 4 E (see page 204).

### [AI5 min value] □ , L 5 ★

AI5 voltage scaling parameter of 0%.

Identical to [AI1 min value] □ , L I (see page 199).

### [AI5 max value] □ , H 5 ★

AI5 voltage scaling parameter of 100%.

Identical to [AI1 max value] □ , H I (see page 199).

### [AI5 min. value] □ r L 5 ★

AI5 current scaling parameter of 0%.

Identical to [AI1 min. value] □ r L I (see page 199).

### [AI5 max. value] □ r H 5 ★

AI5 current scaling parameter of 100%.

Identical to [AI1 max. value] □ r H I (see page 199).

### [AI5 Lowest Process] R , 5 J

AI5 lowest process.

Identical to [AI1 Lowest Process] R , I J (see page 200).

### [AI5 Highest Process] R , 5 K

AI5 highest process.

Identical to [AI1 Highest Process] R , I K (see page 200).

## [DI5 Sensor Configuration] *S* , *F B* - Menu

### Access

[Complete settings] → [Generic functions] → [Sleep/wakeup] → [Sleep menu] → [DI5 Sensor Configuration]

### About This Menu

This menu can be accessed if:

- [Inst. Flow Assign.] *F 5 I A* is set to [DI5 PulseInput Assignment] *P* , *S* , and
- [Sleep Detect Mode] *S L P Π* is set to
  - [Flow] *L F* , or
  - [Multiple] *α r* .

### [DI5 PulseInput Low Freq] *P* , *L 5*

DI5 pulse input low frequency.

Setting	Description
0.00...30,000.00 Hz	Setting range <b>Factory setting:</b> 0.00 Hz

### [DI5 PulseInput High Freq] *P* , *H 5*

DI5 pulse input high frequency.

Setting	Description
0.00...30.00 kHz	Setting range <b>Factory setting:</b> 30.00 kHz

### [DI5 Min Process] *P* , *S J*

Minimum process value for selected input.

Setting	Description
-32,767...32,767	Setting range <b>Factory setting:</b> 0

### [DI5 Max Process] *P* , *S K*

Maximum process value for selected input.

Setting	Description
-32,767...32,767	Setting range <b>Factory setting:</b> 0

## [DI6 Sensor Configuration] 5 , F 9 - Menu

### Access

[Complete settings] → [Generic functions] → [Sleep/wakeup] → [Sleep menu] → [DI6 Sensor Configuration]

### About This Menu

Identical to [DI5 Sensor Configuration] 5 , F 8 - Menu (*see page 206*).

This menu can be accessed if:

- [Inst. Flow Assign.] F 5 I A is set to [DI6 PulseInput Assignment] P , E , and
- [Sleep Detect Mode] 5 L P N is set to
  - [Flow] L F , or
  - [Multiple] o r .

### [DI6 PulseInput Low Freq] P , L E

DI6 pulse input low frequency.

### [DI6 PulseInput High Freq] P , H E

DI6 pulse input high frequency.

### [DI6 Min Process] P , E J

Minimum process value for selected input.

### [DI6 Max Process] P , E K

Maximum process value for selected input.

## [AIV1 Sensor config.] 5 , V / - Menu

### Access

[Complete settings] → [Pump functions] → [Sleep/wakeup] → [Sleep menu] → [AIV1 Sensor config.]

### About This Menu

This menu can be accessed if:

- [Inst. Flow Assign.] F 5 / A is set to [AI Virtual 1] A , U / , and
- [Sleep Detect Mode] S L P N is set to
  - [Flow] L F , or
  - [Multiple] a r .

### [AIV1 Channel Assignment] A , C /

Channel assignment for virtual analog input AIV1.

Setting	Code / Value	Description
[Not Configured]	n a	Not assigned <b>Factory setting</b>
[Ref. Freq-Modbus]	n d b	Reference frequency via Modbus
[Ref. Freq-Com. Module]	n E t	Reference frequency via fieldbus module if a fieldbus module has been inserted

### [AIV1 Lowest Process] A , U / J

AI virtual x: minimum process value.

Setting	Description
-32,767...32,767	Setting range <b>Factory setting:</b> 0

### [AIV1 Highest Process] A , U / K

AI virtual x: maximum process value.

Setting	Description
-32,767...32,767	Setting range <b>Factory setting:</b> 0



**[Sleep menu] *S L P* - Menu****Access**

[Complete settings] → [Generic functions] → [Sleep/wakeup] → [Sleep menu]

**[Sleep Flow Level] *S L n L* ★**

Sleep flow level.

Sensor level under which the system should enter the sleep mode (Zero value to deactivate).

This parameter can be accessed if:

- [Inst. Flow Assign.] *F S I A* is not set to [Not Configured] *n o*, and
- [Sleep Detect Mode] *S L P n* is set to
  - [Flow] *L F*, or
  - [Multiple] *a r*.

Setting ( )	Description
[No] <i>n o</i> to 32,767	Setting range Unit: [Flow rate unit] <i>S u F r</i> (for example, %, l/s; m3/h) Factory setting: [No] <i>n o</i>

**[OutletPres Assign] *P S P A* ★**

Outlet pressure sensor assignment.

This parameter can be accessed if:

- [Sleep Detect Mode] *S L P n* is set to [Pressure] *H P*, or
- [Sleep Detect Mode] *S L P n* is set to [Multiple] *a r*.

This parameter is forced to [Not Configured] *n o*.

Setting	Code / Value	Description
[Not Configured]	<i>n o</i>	Not assigned Factory setting

**[Sleep Min Speed] *S L S L* ★**

Sleep flow level.

Speed level under which the system should enter the sleep mode.

This parameter can be accessed if:

- [Sleep Detect Mode] *S L P n* is set to [Speed] *S P d*, or
- [Sleep Detect Mode] *S L P n* is set to [Multiple] *a r*.

Setting ( )	Description
0...500.0 Hz	Setting range Factory setting: [No] <i>n o</i>

**[Sleep Power Level] *S L P r* ★**

Sleep power level.

Power level under which the system should enter the sleep mode.

This parameter can be accessed if:

- [Sleep Detect Mode] *S L P n* is set to [Power] *P W r*, or
- [Sleep Detect Mode] *S L P n* is set to [Multiple] *a r*.

Setting ( )	Description
0...[Nominal Motor Power] <i>n P r</i>	Setting range Factory setting: [No] <i>n o</i>

**[Sleep Delay] *S L P d* ★**

Sleep delay.

This parameter can be accessed if **[Sleep Detect Mode] *S L P n*** is not set to **[Not Configured] *n o***.

Setting ( )	Description
0...3,600 s	Setting range <b>Factory setting:</b> 20 s

**[Boost] 5 b t - Menu****Access**

[Complete settings] → [Generic functions] → [Sleep/wakeup] → [Sleep menu] → [Boost]

**About This Menu**

Following parameters can be accessed if [Sleep Detect Mode] 5 L P  $\Pi$  is not set to [No] n o .

**[Sleep Boost Speed] 5 L b 5 ★**

Sleep boost speed.

Setting ( )	Description
0...599.0 Hz	Setting range Factory setting: n o

**[Sleep Boost Time] 5 L b t ★**

Sleep boost time.

Setting ( )	Description
0...3,600 s	Setting range Factory setting: n o

## [Advanced sleep check] *P r E S - Menu*

### Access

[Complete settings] → [Generic functions] → [Sleep/wakeup] → [Sleep menu] → [Advanced sleep check]

### About This Menu

This function can be activated if:

- [Type of control] *E o C E* is set to [Pressure] *P r E S S* and,
- [Sleep Detect Mode] *S L P M* is not set to [No] *n o*.

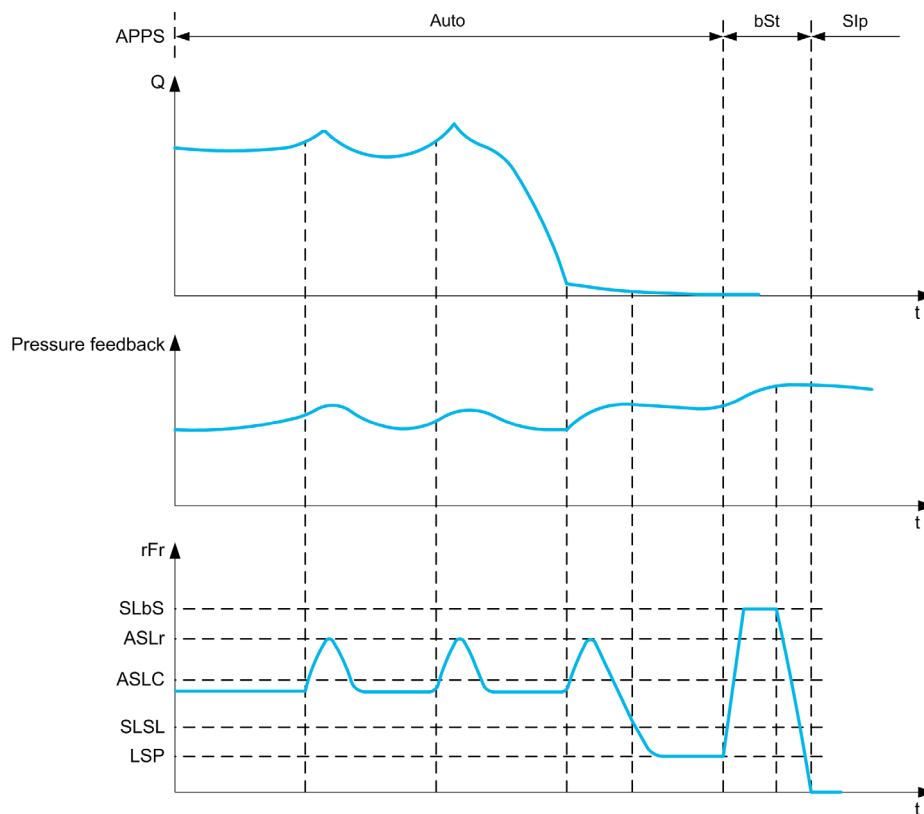

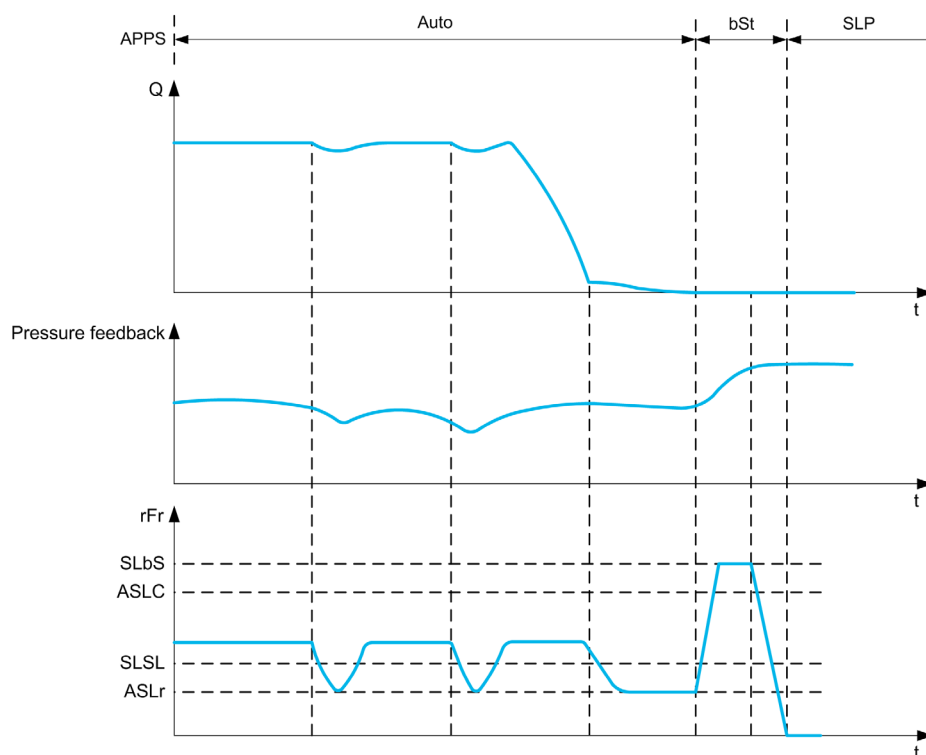

### [Sleep Mode] #5LΠ

Advanced sleep mode.

Setting ( )	Code / Value	Description
[No]	n o	No Factory setting
[YES]	y e s	Yes

### [Sleep Condition] #5LC★

Advanced sleep verifies speed condition.

This parameter can be accessed if [Sleep Mode] #5LΠ is not set to [No] n o.

Setting ( )	Description
0...[High Speed] #5P	Setting range Factory setting: 0.0 Hz

### [Sleep Delay] #5LD★

Advanced sleep verifies delay.

This parameter can be accessed if [Sleep Mode] #5LΠ is not set to [No] n o.

Setting ( )	Description
0...9,999 s	Setting range Factory setting: 20 s

**[Check Sleep Ref Spd]** *H 5 L r* ★

Advanced sleep verifies speed reference.

This parameter can be accessed if **[Sleep Mode]** *H 5 L Π* is not set to **[No]** *r a*.

Setting ( )	Description
0... <b>[High Speed]</b> <i>H 5 P</i>	Setting range <b>Factory setting:</b> 0.0 Hz

## [Wake up menu] WK P - Menu

### Access

[Complete settings] → [Generic functions] → [Sleep/wakeup] → [Wake up menu]

### About This Menu

This menu can be accessed if [Sleep Detect Mode] SL P Π is not set to [Not Configured] n o.

### [Wake Up Mode] W U P Π ★

Wake-up mode.

Setting	Code / Value	Description
[Feedback]	F b K	Wake-up on PID feedback level <b>Factory setting</b>
[Error]	E r r	Wake-up on PID error level
[Pressure]	L P	Wake-up on low-pressure condition

### [Wake Up Process Level] W U P F ★

Wake-up process value level.

This parameter can be accessed if [Wake Up Mode] W U P Π is set to [Feedback] F b K.

Setting ( )	Description
[Min PID feedback] P , F 1...[Max PID feedback] P , F 2	Setting range <b>Factory setting:</b> 0

### [Wake Up Process Error] W U P E ★

Wake-up process value error level.

This parameter can be accessed if [Wake Up Mode] W U P Π is set to [Error] E r r.

Setting ( )	Description
0...[Max PID feedback] P , F 2	Setting range <b>Factory setting:</b> 0,0 Hz

### [OutletPres Assign] P S 2 A ★

Outlet pressure sensor assignment.

This parameter can be accessed if [Wake Up Mode] W U P Π is set to [Pressure] L P.

This parameter is forced to [Not Configured] n o.

Setting	Code / Value	Description
[Not Configured]	n o	Not assigned <b>Factory setting</b>

### [Wake Up Press Level] W U P L ★

Wake-up pressure level.

Pressure level over which the system should leave the sleep mode.

This parameter can be accessed if [Wake Up Mode] W U P Π is set to [Pressure] L P.

Setting ( )	Description
[No] n o to 32,767	Setting range Unit: [P sensor unit] S U P r (for example, Pa, Bar, PSI, %) <b>Factory setting:</b> [No] n o

[Wake Up Delay] W u P d ★

Wake-up delay.

Setting ( )	Description
0...3,600 s	Setting range <b>Factory setting:</b> 0 s



## Section 6.14

### [Generic functions] - [Threshold reached]

#### [Threshold reached] *L H r E* - Menu

##### Access

[Complete settings] → [Generic functions] → [Threshold reached]

##### [Low I Threshold] *L L d L*

Current low threshold value (for [Low Current Reached] *L L R L* warning).

Setting (◀)	Description
0...1.5 in	Setting range Factory setting: 0.2 A

##### [High Current Thd] *L L d*

Current high threshold value (for [Current Thd Reached] *L L R* warning).

Setting (◀)	Description
0...1.5 in	Setting range Factory setting: Drive nominal current

##### [Low Freq. Threshold] *F L d L*

Motor low frequency threshold (for [Mot Freq Low Thd] *F L R L* warning).

Setting (◀)	Description
0.0...500.0 Hz	Setting range Factory setting: 0.0 Hz

##### [Motor Freq Thd] *F L d*

Motor frequency threshold (for [Mot Freq High Thd] *F L R* warning).

Setting (◀)	Description
0.0...500.0 Hz	Setting range Factory setting: 50.0 Hz

##### [2 Freq. Threshold] *F 2 d L*

Motor low frequency second threshold (for [Mot Freq Low Thd 2] *F 2 R L* warning).

Setting (◀)	Description
0.0...500.0 Hz	Setting range Factory setting: 0.0 Hz

##### [Freq. threshold 2] *F 2 d*

Motor frequency threshold 2 (for [Mot Freq High Thd 2] *F 2 R* warning).

Setting (◀)	Description
0.0...500.0 Hz	Setting range Factory setting: 50.0 Hz

**[Motor Thermal Thd] *r t d***

Motor thermal state threshold (for **[Motor Therm Thd reached] *r t H*** warning).

Setting (°)	Description
0...118%	Setting range Factory setting: 100%

**[Reference high Thd] *r t d***

Reference frequency high threshold (for **[Ref Freq High Thd reached] *r t H H*** warning).

Setting (°)	Description
0.0...500.0 Hz	Setting range Factory setting: 0.0 Hz

**[Reference low Thd] *r t d L***

Reference frequency low threshold (for **[Ref Freq Low Thd reached] *r t H L*** warning).

Setting (°)	Description
0.0...500.0 Hz	Setting range Factory setting: 0.0 Hz

## Section 6.15

### [Generic functions] - [Mains contactor command]

#### [Mains contactor command] L L C - Menu

##### Access

[Complete settings] → [Generic functions] → [Mains contactor command]

##### About This Menu

The line contactor closes every time a run command (forward or reverse) is sent and opens after every stop, as soon as the drive is locked. For example, if the stop mode is stop on ramp, the contactor opens when the motor reaches zero speed.

**NOTE:** The drive control power supply must be provided via an external 24 Vdc source.

### NOTICE

#### DAMAGE TO THE DRIVE

Do not use this function at intervals of less than 60 s.

**Failure to follow these instructions can result in equipment damage.**

Example circuit (24 Vdc power supply):

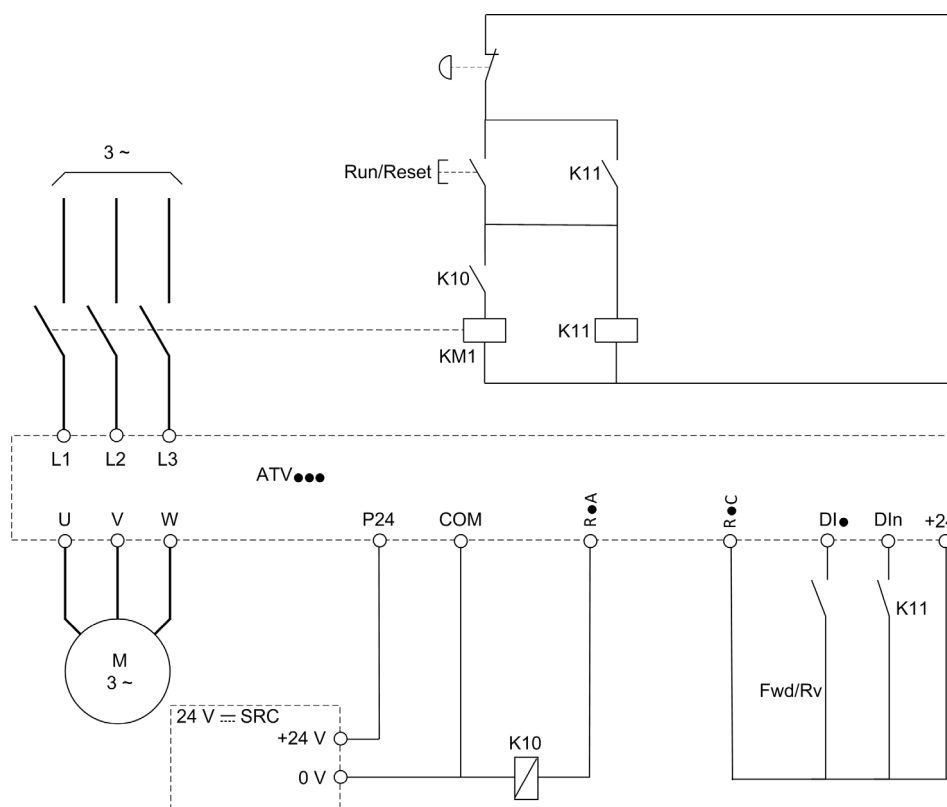

DI• = Run command [Forward] *F r d* or [Reverse] *r r 5*

R•A/R•C = [Mains Contactor] *L L C*

DIin = [Drive Lock] *L E 5*

**NOTE:** The Run/Reset key must be pressed once the emergency stop key has been released.

**[Mains Contactor] L L C**

Mains contactor control.

Setting	Code / Value	Description
[No]	n 0	Not assigned <b>Factory setting</b>
[R1]...[R3]	r 1...r 3	Relay output R1...R3
[R4]...[R6]	r 4...r 6	Relay output R4...R6 if VW3A3204 relay output option module has been inserted
[DQ11 Digital Output]...[DQ12 Digital Output]	d 0 1 1...d 0 1 2	Digital output DQ11...DQ12 if VW3A3203 I/O extension module has been inserted

**[Drive Lock] L E 5 ★**

Drive lock assignment.

This parameter can be accessed if **[Mains Contactor] L L C** is not set to **[No] n 0**.

The drive locks when the assigned input or bit changes to 0.

Setting	Code / Value	Description
[Not Assigned]	n 0	Not assigned <b>Factory setting</b>
[CD00]...[CD10]	C d 0 0...C d 1 0	Virtual digital input CMD.0...CMD.10 in <b>[I/O profile]</b> , 0 configuration
[CD11]...[CD15]	C d 1 1...C d 1 5	Virtual digital input CMD.11...CMD.15 in <b>[I/O profile]</b> , 0 configuration
[C101]...[C110]	C 1 0 1...C 1 1 0	Virtual digital input CMD1.01...CMD1.10 with integrated Modbus Serial in <b>[I/O profile]</b> , 0 configuration
[C111]...[C115]	C 1 1 1...C 1 1 5	Virtual digital input CMD1.11...CMD1.15 with integrated Modbus Serial in <b>[I/O profile]</b> , 0 configuration
[C301]...[C310]	C 3 0 1...C 3 1 0	Virtual digital input CMD3.01...CMD3.10 with a fieldbus module in <b>[I/O profile]</b> , 0 configuration
[C311]...[C315]	C 3 1 1...C 3 1 5	Virtual digital input CMD3.11...CMD3.15 with a fieldbus module in <b>[I/O profile]</b> , 0 configuration
[DI1 (Low level)]...[DI6 (Low level)]	L 1 L...L 6 L	Digital input DI1...DI6 used at low level
[DI11 (Low level)]...[DI16 (Low level)]	L 1 1 L...L 1 6 L	Digital input DI11...DI16 used at low level if VW3A3203 I/O extension module has been inserted

**[Mains V. time out] L C E**

Monitoring time for closing of line contactor.

Setting	Description
1...999 s	Setting range <b>Factory setting:</b> 5 s

---

## Section 6.16

### [Generic functions] - [Parameters switching]

---

#### What Is in This Section?

This section contains the following topics:

Topic	Page
[Parameters switching] <i>Π L P</i> - Menu	222
[Set 1] <i>P 5 1</i> - Menu	224
[Set 2] <i>P 5 2</i> - Menu	224
[Set 3] <i>P 5 3</i> - Menu	224

**[Parameters switching] П L P - Menu**

**Access**

[Complete settings] → [Generic functions] → [Parameters switching]

**About This Menu**

A set of 1 to 15 parameters from the [Parameter Selection] 5 P 5 list (see page 223) can be selected and 2 or 3 different values assigned. These 2 or 3 sets of values can then be switched using 1 or 2 digital inputs or control word bits. This switching can be performed during operation (motor running). It can also be controlled based on 1 or 2 frequency thresholds, whereby each threshold acts as a digital input (0 = threshold not reached, 1 = threshold reached).

	Values 1	Values 2	Values 3
Parameter 1 ... Parameter 15	Parameter 1 ... Parameter 15	Parameter 1 ... Parameter 15	Parameter 1 ... Parameter 15
Input DI or bit or frequency threshold 2 values	0	1	0 or 1
Input DI or bit or frequency threshold 3 values	0	0	1

**NOTE:** Do not modify the parameters in [Parameter Selection] 5 P 5 (see page 223), because any modifications made in this menu will be lost on the next power-up. The parameters can be adjusted during operation in the [Parameters switching] П L P - menu, on the active configuration.

**[2 Parameter sets] C H A 1**

Parameter switching assignment 1.  
Switching 2 parameter sets.

Setting	Code / Value	Description
[Not Assigned]	n o	Not assigned <b>Factory setting</b>
[Mot Freq High Thd]	F L A	Motor frequency high threshold reached
[2nd Freq Thd Reached]	F 2 A	Second frequency threshold reached
[DI1]...[DI6]	L , 1...L , 6	Digital input DI1...DI6
[DI11]...[DI16]	L , 11...L , 16	Digital input DI11...DI16 if VW3A3203 I/O extension module has been inserted
[CD00]...[CD10]	C d 0 0...C d 1 0	Virtual digital input CMD.0...CMD.10 in [I/O profile] , o configuration
[CD11]...[CD15]	C d 1 1...C d 1 5	Virtual digital input CMD.11...CMD.15 regardless of configuration
[C101]...[C110]	C 1 0 1...C 1 1 0	Virtual digital input CMD1.01...CMD1.10 with integrated Modbus Serial in [I/O profile] , o configuration
[C111]...[C115]	C 1 1 1...C 1 1 5	Virtual digital input CMD1.11...CMD1.15 with integrated Modbus Serial regardless of configuration
[C301]...[C310]	C 3 0 1...C 3 1 0	Virtual digital input CMD3.01...CMD3.10 with a fieldbus module in [I/O profile] , o configuration
[C311]...[C315]	C 3 1 1...C 3 1 5	Virtual digital input CMD3.11...CMD3.15 with a fieldbus module regardless of configuration

**[3 Parameter sets] C H A 2**

Parameter switching assignment 2.  
Identical to [2 Parameter sets] C H A 1.  
Switching 3 parameter sets.

**NOTE:** In order to obtain 3 parameter sets, it is necessary to configure first [2 Parameter sets] C H A 1.

**[Parameter Selection] 5 P 5**

This parameter can be accessed if **[2 Parameter sets] C H R 1** is not set to **[No] n o**.

Making an entry in this parameter opens a window containing all the adjustment parameters that can be accessed. Select 1 to 15 parameters using **OK** key. Parameter(s) can also be deselected using **OK** key.

Available parameters for parameters switching function are:

Parameter	Code
[Ramp increment]	<i>i n r</i>
[Acceleration]	<i>A C C</i>
[Deceleration]	<i>d E C</i>
[Acceleration 2]	<i>A C 2</i>
[Deceleration 2]	<i>d E 2</i>
[Begin Acc round]	<i>t R 1</i>
[End Acc round]	<i>t R 2</i>
[Begin Dec round]	<i>t R 3</i>
[End Dec round]	<i>t R 4</i>
[Low Speed]	<i>L S P</i>
[High Speed]	<i>H S P</i>
[Motor Th Current]	<i>i t H</i>
[IR compensation]	<i>u F r</i>
[Ramp Divider]	<i>d C F</i>
[DC Inj Level 1]	<i>i d C</i>
[DC Inj Time 1]	<i>t d 1</i>
[DC Inj Level 2]	<i>i d C 2</i>
[DC Inj Time 2]	<i>t d C</i>
[Auto DC inj Level 1]	<i>S d C 1</i>
[Auto DC Inj Time 1]	<i>t d C 1</i>
[Auto DC inj Level 2]	<i>S d C 2</i>
[Auto DC Inj Time 2]	<i>t d C 2</i>
[Switching frequency]	<i>S F r</i>
[Current Limitation]	<i>C L 1</i>
[Low Speed Timeout]	<i>t L S</i>
[Preset speed 2]...[Preset speed 16]	<i>S P 2... S P 16</i>
[Ref PID Preset 2]	<i>r P 2</i>
[Ref PID Preset 3]	<i>r P 3</i>
[Freq. threshold 2]	<i>F 2 d</i>
[2 Freq. Threshold]	<i>F 2 d L</i>
[Skip Frequency]	<i>J P F</i>
[Skip Frequency 2]	<i>J F 2</i>
[3rd Skip Frequency]	<i>J F 3</i>
[Skip Freq.Hysteresis]	<i>J F H</i>

## [Set 1] P 5 1 - Menu

### Access

[Complete settings] → [Generic functions] → [Parameters switching] → [Set 1]

### About This Menu

Making an entry in this menu opens a settings window containing the selected parameters in the order in which they were selected.

## [Set 2] P 5 2 - Menu

### Access

[Complete settings] → [Generic functions] → [Parameters switching] → [Set 2]

### About This Menu

Identical to [Set 1] P 5 1 - (*see page 224*).

## [Set 3] P 5 3 - Menu

### Access

[Complete settings] → [Generic functions] → [Parameters switching] → [Set 3]

### About This Menu

Identical to [Set 1] P 5 1 - (*see page 224*).



## Section 6.17

### [Generic functions] - [Stop after speed timeout]

#### [Stop after speed timeout] $P r 5 P$ - Menu

##### Access

[Complete settings] → [Generic functions] → [Stop after speed timeout]

##### Sleep/Wake-Up in Speed Control Mode

The drive is in Speed control mode, when PID is not active, typically when:

- PID is not configured (the motor speed setpoint is controlled by an external PLC, for example).
- PID is in manual mode (manual application mode, for example).
- PID is not active because Channel 1 is not selected (forced local mode enabled, for example).

When the drive is used in Speed Control (PID not used or not active), a speed condition is used to switch the application to the sleep state. When the drive is in sleep state, the motor is restarted if the sleep condition disappears.

This function avoids prolonged operation at low speeds when neither useful nor compliant with the system constraints. It stops the motor after a period of operation at reduced speed. This time and speed can be adjusted.

In Speed control mode, Sleep/Wake-up is managed according to the following rules:

- The motor is stopped when [Pre-Ramp Ref Freq]  $F r H$  and [Output frequency]  $r F r$  become and stay lower than [Low speed]  $L 5 P$  + [Sleep Offset Thres.]  $5 L E$  during [Low Speed Timeout]  $t L 5$ .
- The motor is restarted when [Pre-Ramp Ref Freq]  $F r H >$  [Low speed]  $L 5 P$  + [Sleep Offset Thres.]  $5 L E$ .

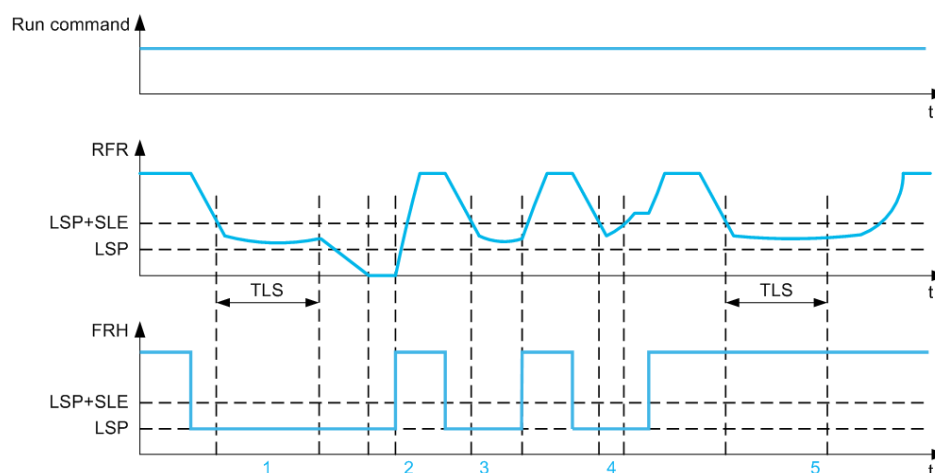

- 1 Nominal [Low Speed Timeout]  $t L 5$  function action: after [Low Speed Timeout]  $t L 5$  time, the motor is stopped according to the current deceleration ramp
- 2 [Pre-Ramp Ref Freq]  $F r H$  becomes greater than [Low speed]  $L 5 P$  + [Sleep Offset Thres.]  $5 L E$  and run order still present [Low Speed Timeout]  $t L 5$  function is deactivated
- 3 [Low Speed Timeout]  $t L 5$  function is not activated because [Pre-Ramp Ref Freq]  $F r H$  becomes greater than [Low speed]  $L 5 P$  + [Sleep Offset Thres.]  $5 L E$  before [Low Speed Timeout]  $t L 5$  has expired
- 4 [Low Speed Timeout]  $t L 5$  function is not activated because [Output frequency]  $r F r$  becomes greater than [Low speed]  $L 5 P$  + [Sleep Offset Thres.]  $5 L E$  before [Low Speed Timeout]  $t L 5$  has expired
- 5 [Low Speed Timeout]  $t L 5$  function is not activated because [Pre-Ramp Ref Freq]  $F r H$  stays greater than [Low speed]  $L 5 P$  + [Sleep Offset Thres.]  $5 L E$

**[Low Speed Timeout] L L 5**

Low speed timeout

Setting ( )	Description
0.0...999.9 s	Setting range <b>Factory setting:</b> 0.0 s

**[Sleep Offset Thres.] S L E ★**

Sleep offset threshold.

This parameter can be accessed if **[Low Speed Timeout] L L 5** is not set to 0.Adjustable restart threshold (offset) following a stop after prolonged operation at **[Low speed] L S P + [Sleep Offset Thres.] S L E**, in Hz. The motor restarts if the reference rises above (LSP + SLE) and if a run command is still present.

Setting ( )	Description
1.0... <b>[Max Frequency] L F r</b>	Setting range <b>Factory setting:</b> 1.0 Hz

## Section 6.18

### [Generic functions] - [Advanced sleep check] *A d S* - Menu

#### [Advanced sleep check] *A d S* - Menu

##### Access

[Complete settings] → [Generic functions] → [Advanced sleep check]

##### About This Menu

This function can be activated if:

- [Type of control] *E o C E* is set to [Pressure] *P r E S S* and,
- [Sleep Detect Mode] *S L P M* is not set to [No] *n o*.

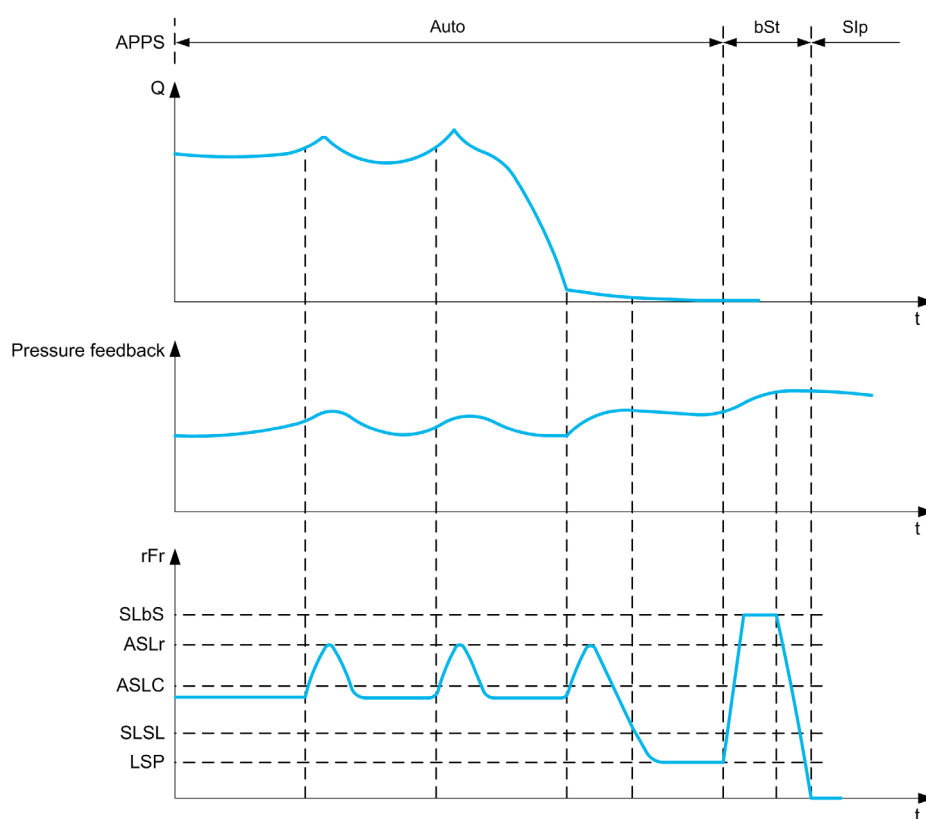

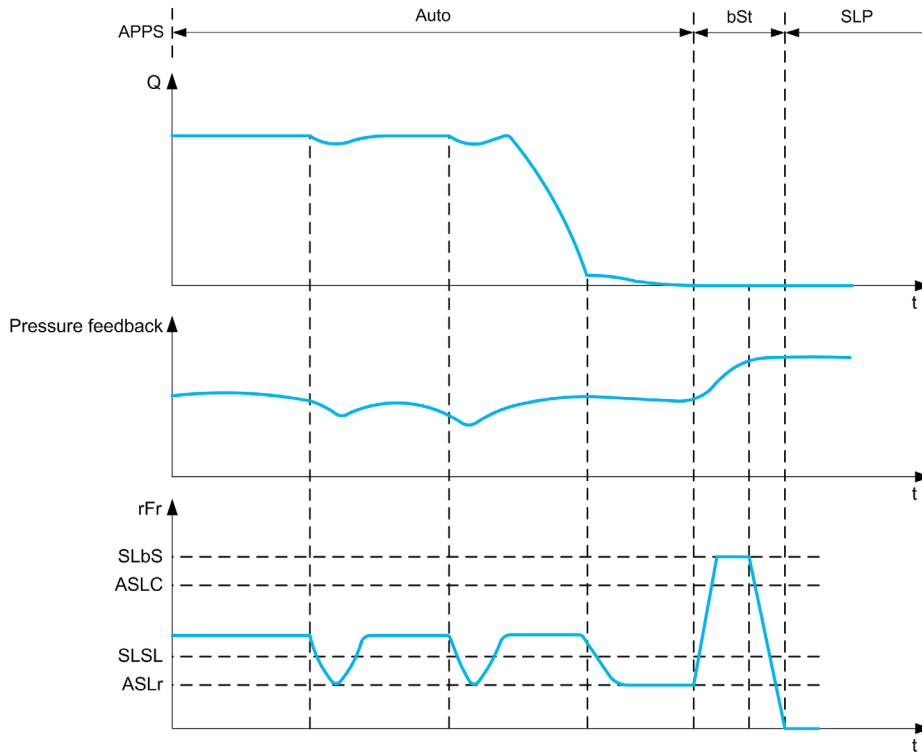

**[Sleep Mode] # 5 L 7**

Advanced sleep mode.

Setting ( )	Code / Value	Description
[No]	n o	No Factory setting
[YES]	y e s	Yes

**[Sleep Condition] # 5 L C ★**

Advanced sleep verifies speed condition.

This parameter can be accessed if **[Sleep Mode] # 5 L 7** is not set to **[No] n o**.

Setting ( )	Description
0...[High Speed] # 5 P	Setting range Factory setting: 0.0 Hz

**[Sleep Delay] # 5 L d ★**

Advanced sleep verifies delay.

This parameter can be accessed if **[Sleep Mode] # 5 L 7** is not set to **[No] n o**.

Setting ( )	Description
0...9,999 s	Setting range Factory setting: 20 s

**[Check Sleep Ref Spd] # 5 L r ★**

Advanced sleep verifies speed reference.

This parameter can be accessed if **[Sleep Mode] # 5 L 11** is not set to **[No] n o**.

Setting ( )	Description
0...599.0 Hz	Setting range <b>Factory setting:</b> 0.0 Hz

## Section 6.19

### [Generic functions] - [Booster control]

#### Introduction

The aim of the booster control function is to maintain the desired pressure or flow at the outlet of the pumps according to the demand by:

- Managing the velocity of the variable speed pump connected to the drive.
- Staging/De-staging the auxiliary fixed speed pumps.

#### What Is in This Section?

This section contains the following topics:

Topic	Page
[System Architecture] П P 9 - Menu	231
[Pumps configuration] P u П P - Menu	235
[System Architecture] П P 9 - Menu	238
[Booster control] б 5 C - Menu	239
[Stage/Destage condition] 5 d C П - Menu	240
[Booster control] б 5 C - Menu	241

## [System Architecture] ПРЧ - Menu

### Access

[Complete settings] → [Generic functions] → [Booster control] → [System architecture]

### About This Menu

This menu is used to define the equipment architecture.

The architecture is chosen by setting [Pump System Arch] ПPSA to [Single Drive] UNDBL: one variable speed pump and up to five fixed speed pumps.

In single drive architecture, the total number of pumps is set with [Nb Of Pumps] ПPN:

- With lead pump alternation, using interlocked switching relays for all pumps to connect them on mains or on the drive.
- Without lead pump alternation, using digital outputs to command the auxiliary pumps (with soft starters for example). The lead pump is always connected to the drive.

In multiple drives architecture, the number of pumps is set with [Nb of Devices] ПGN. Lead pump alternation is not possible in this case.

### Pump Cycling Mode

This functionality allows changing the start order of all available pumps in order to manage their wear.

There are several ways to perform the pump cycling strategy by setting [Pump Cycling Mode] ПPC:

- Cycling based on pump order:
  - [FIFO] F, F mode: pumps are started and stopped in ascending order
  - [LIFO] L, F mode: pumps are started in ascending order while they are stopped in descending order
- Cycling based on running time:
  - [Runtime] R, PE: the available pump with the lowest running time is started first and the running pump with the highest running time is stopped first.

### Lead Pump Alternation

The lead pump alternation function allows permuting the available pumps in order that each pump can become the lead pump (variable speed pump) instead of an auxiliary pump (fixed speed pump).

The lead pump is the first pump to be started and the last pump to be stopped. It is always associated to the variable speed drive.

The function can be activated by setting [Lead Pump Alternation] ПPLA:

- [No] NO: no lead pump alternation, the pump 1 is always the lead pump. The pump cycling is applied only on auxiliary pumps.
- [Stage] STEGE: The lead pump is permuted between all available pumps at each stage. In this mode a pump cycling strategy is followed to stage or destage a pump.
  - When the needed pressure exceeds the already running pumps capability, the next pump is staged as lead pump and previous pumps becomes fixed speed pumps.
  - The time delay needed to switch between pumps can be adjust using [Altern Wait Time] ПPRL.
  - When the needed pressure becomes lower than the lead pump capability, the fixed speed pumps are destaged following the [Pump Cycling Mode] ПPC

When lead pump alternation is activated, catch on fly function should be configured to reduce over current when a pump is started as the lead pump while it was running as auxiliary pump before. It is also possible to set [Pump Ready Delay] ПPRD to delay the availability of an auxiliary pump for a new start after it has been stopped.

### Automatic Period Cycling

This function is used to balance the duty sharing of all the pumps of the MultiPump architecture.

It forces the pump alternation based on the time defined by [Pump Auto Cycling] ПPCP. The goal is to extend the life time of each pump.

**Display Parameters**

A set of parameters to display the system is available in [Application Parameters] *APP* -, [Variable Speed Pump] *VSP* - :

- The quantity of pumps available [Available Pumps] *APN* and the quantity of pump already staged [Nb of Staged Pumps] *NSN*.
- The number of the pump selected to be the lead pump [Lead Pump] *PLD*.
- The number of the next pump to be staged [Next Staged Pump] *PNS* and de-staged [Next Destaged Pump] *PND*.
- For each pump (pump 1 in the example):
  - The state [Pump 1 State] *P1S*
  - The type [Pump 1 Type] *P1T*
  - The cumulated run time [Pump 1 Runtime] *P1RT*
  - The cumulated number of starts [Pump 1 Nb Starts] *P1NS*

**Example of Architecture Without Lead Pump Alternation and Two Fixed Speed Pumps**

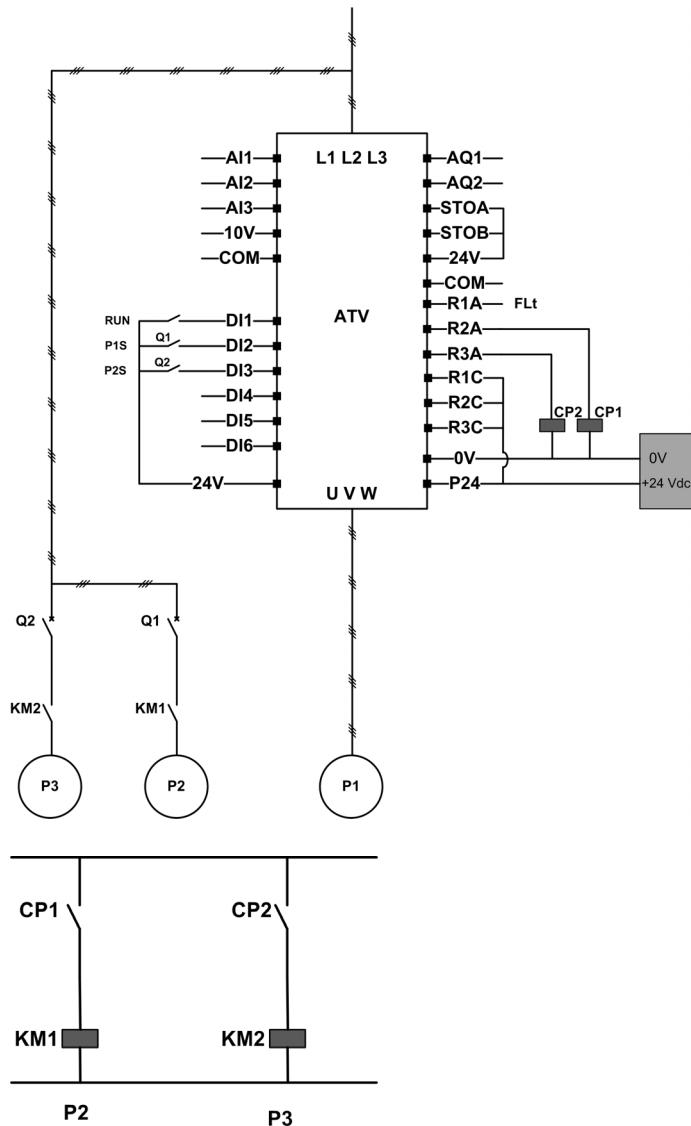

Pump 2 and pump 3 are controlled by relay outputs R2 and R3.

The state of each pump is provided to the drive via digital inputs DI2 and DI3:

- 1 = the pump is ready to operate.
- 0 = the pump is not available.

KM1 is switched ON when CP1 is activated. CP1 is controlled via the relay output R2.

KM2 is switched ON when CP2 is activated. CP2 is controlled via the relay output R3.

Q1 and Q2 must be switched ON to have both pump 2 and pump 3 ready to operate.



## Example of Architecture with Lead Pump Alternation on Three Pumps

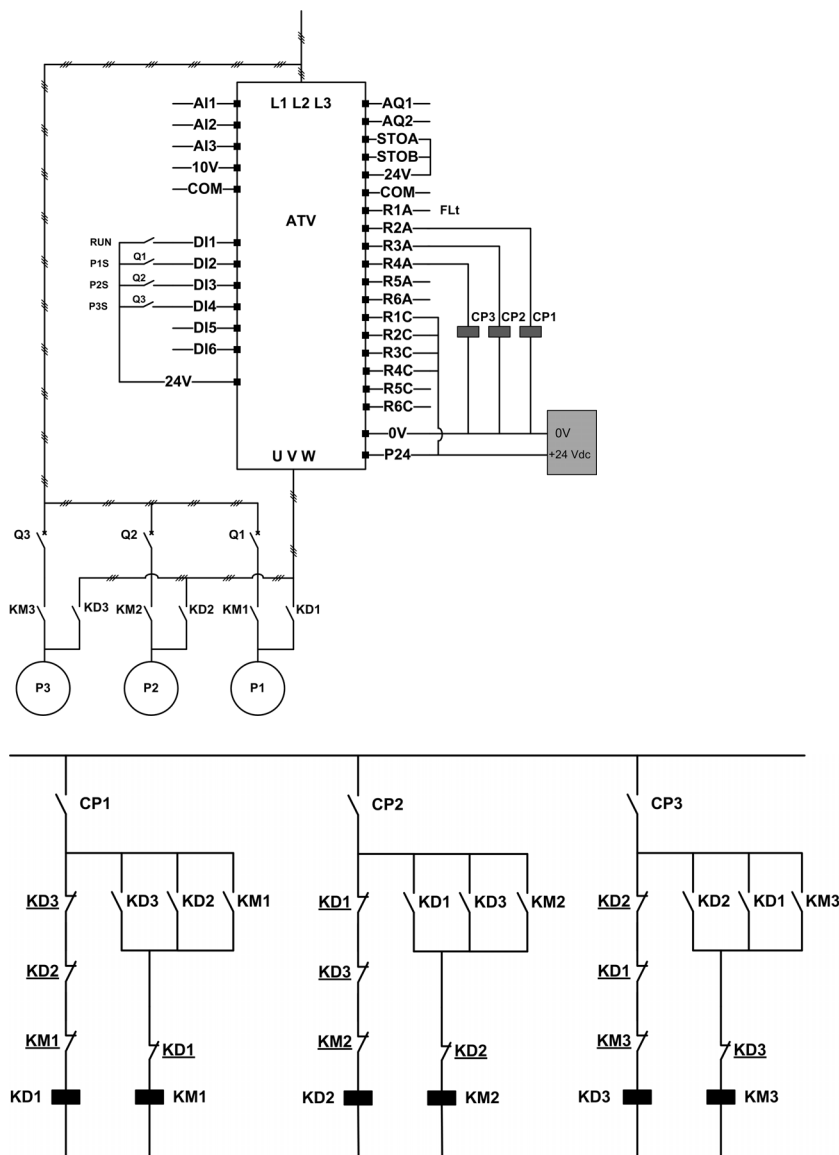

Each pump is controlled by a relay output:

- Pump 1 control via relay output R2.
- Pump 2 control via relay output R3.
- Pump 3 control via relay output R4.

The state of each pump is provided to the drive via digital inputs DI2, DI3, and DI4:

- 1 = the pump is ready to operate.
- 0 = the pump is not available.

If the relay output R2 is the first activated, the pump 1 becomes the lead pump. CP1 is switched ON via relay output R2, KD1 is switched ON and the pump 1 is connected to the drive.

The other pumps cannot be connected to the drive thanks to KD1 (switched OFF) which prevent KD2 and KD3 to be activated when CP2 and CP3 are switched ON. The other pumps become auxiliary pumps and they are connected to the supply mains through KM2 and KM3 which are activated when, respectively, CP2 and CP3 are switched ON, that is, when R3 and R4 are activated.

When relay output R3 is the first activated, the pump 2 becomes the lead pump. The other pumps become auxiliary pumps which are connected to the supply mains via KM1 and KM3.

When relay output R4 is the first activated, the pump 3 becomes the lead pump. The other pumps become auxiliary pumps which are connected to the supply mains via KM1 and KM2.

Q1, Q2, and Q3 must be switched ON to have all pumps ready to operate.

To change the lead pump, it is necessary to deactivate all relay outputs which means that all pumps must be already stopped. It is then possible to decide which relay output to be activated first and so defining the new lead pump.

**[Pump System Archi] П P S A**

Pump system architecture selection.

Setting	Code / Value	Description
[Mono-Pump]	<i>n o</i>	Multi-pump control deactivated <b>Factory setting</b>
[Single Drive]	<i>V n d o L</i>	Single drive with or without auxiliary pumps

**[Nb Of Pumps] П P P n ★**

Number of pumps.

This parameter can be accessed if [Pump System Archi] П P S A is set to [Single Drive] *V n d o L*.

Setting	Description
1...6	Setting range <b>Factory setting:</b> 1

## [Pumps configuration] $P \cup \Pi P$ - Menu

### Access

[Complete settings] → [Generic functions] → [Booster control] → [System architecture] → [Pumps configuration]

### Input and Output Configuration for Each Pump

For each pump (pump 1 in the example), it is possible to set:

- The drive digital output for the command: **[Pump 1 Cmd Assign]  $\Pi P \alpha I$**  if **[Lead Pump Alternation]  $\Pi P L R$**  is not set to **[No]  $n \alpha$** .
- The drive digital input for the pump availability information: **[Pump 1 Ready Assign]  $\Pi P , I$** . If not configured, the pump is considered as always available.

An internal configurable delay **[Pump Ready Delay]  $\Pi P , d$**  is available. When the digital input assigned to **[Pump 1 Ready Assign]  $\Pi P , I$**  switches to the active state or after de-staging, the related pump is considered as not available during **[Pump Ready Delay]  $\Pi P , d$** .

This is used to wait that the auxiliary pumps are stopped and that all contactors between the drive and the motor (if existing) are closed before staging.

### Warnings and Errors Handling

If the available capacity of the system is exceeded:

- **[MultiPump Capacity Warn]  $\Pi P C R$**  warning is active if the number of pumps to be started is higher than the number of available pumps.

**NOTE:** If the number of available pump is equal to 0, the warning is active.

If the selected lead pump is not available:

- A **[Lead Pump Warn]  $\Pi P L R$**  warning is active if the lead pump becomes not available while in run or if there is no lead pump available at run command.
- A **[Lead Pump Error]  $\Pi P L F$**  error is active if the lead pump becomes not available while in run. If configured, the delay **[Pump Ready Delay]  $\Pi P , d$**  is applied on the error triggering if there is no lead pump available at run command.  
This error is handled whatever the active command channel if booster control or level control function is configured.

The drive response to a **[Lead Pump Error]  $\Pi P L F$**  is set with **[MultiPump ErrorResp]  $\Pi P F b$**  parameter.

### [Pump 1 Cmd Assign] $\Pi P \alpha I$ ★

Command assignment for pump 1.

This parameter can be accessed if:

- **[Pump System Archi]  $\Pi P S R$**  is set to **[Multi Drives]  $n V S d$**  or **[Multi Masters]  $n V S d r$**  or,
- **[Pump System Archi]  $\Pi P S R$**  is set to **[Single Drive]  $V n d \alpha L$**  and **[Nb Of Pumps]  $\Pi P P n$**  is set to **[1]  $I$**  or above.

This parameter can be accessed if **[Nb Of Pumps]  $\Pi P P n$**  is set to **[1]  $I$**  or above.

Setting	Code / Value	Description
<b>[No]</b>	$n \alpha$	Not assigned <b>Factory setting</b>
<b>[R1]...[R3]</b>	$r 1 \dots r 3$	Relay output R1...R3
<b>[R4]...[R6]</b>	$r 4 \dots r 6$	Relay output R4...R6 if VW3A3204 relay output option module has been inserted
<b>[DQ11 Digital Output]...[DQ12 Digital Output]</b>	$d \alpha 1 1 \dots d \alpha 1 2$	Digital output DQ11...DQ12 if VW3A3203 I/O extension module has been inserted

**[Pump 1 Ready Assign]  $\Pi P , 1$  ★**

Pump 1 ready to operate assignment.

This parameter can be accessed if **[Nb Of Pumps]  $\Pi P P n$**  is set to **[1] 1** or above.

Setting	Code / Value	Description
[Not Assigned]	$n 0$	Not assigned <b>Factory setting</b>
[DI1]...[DI6]	$L , 1 \dots L , 6$	Digital input DI1...DI6
[DI11]...[DI16]	$L , 11 \dots L , 16$	Digital input DI11...DI16 if VW3A3203 I/O extension module has been inserted
[CD00]...[CD10]	$C d 00 \dots C d 10$	Virtual digital input CMD.0...CMD.10 in <b>[I/O profile] , 0</b> configuration
[CD11]...[CD15]	$C d 11 \dots C d 15$	Virtual digital input CMD.11...CMD.15 regardless of configuration
[C101]...[C110]	$C 101 \dots C 110$	Virtual digital input CMD1.01...CMD1.10 with integrated Modbus Serial in <b>[I/O profile] , 0</b> configuration
[C111]...[C115]	$C 111 \dots C 115$	Virtual digital input CMD1.11...CMD1.15 with integrated Modbus Serial regardless of configuration
[C301]...[C310]	$C 301 \dots C 310$	Virtual digital input CMD3.01...CMD3.10 with a fieldbus module in <b>[I/O profile] , 0</b> configuration
[C311]...[C315]	$C 311 \dots C 315$	Virtual digital input CMD3.11...CMD3.15 with a fieldbus module regardless of configuration
[DI1 (Low level)]...[DI6 (Low level)]	$L 1L \dots L 6L$	Digital input DI1...DI6 used at low level

**[Pump 2 Cmd Assign]  $\Pi P 0 2$  ★**

Command assignment for pump 2.

This parameter can be accessed if **[Nb Of Pumps]  $\Pi P P n$**  is set to **[2] 2** or above.

Identical to **[Pump 1 Cmd Assign]  $\Pi P 0 1$**  (*see page 235*).

**[Pump 2 Ready Assign]  $\Pi P , 2$  ★**

Pump 2 ready to operate assignment.

This parameter can be accessed if **[Nb Of Pumps]  $\Pi P P n$**  is set to **[2] 2** or above.

Identical to **[Pump 1 Ready Assign]  $\Pi P , 1$**  (*see page 236*).

**[Pump 3 Cmd Assign]  $\Pi P 0 3$  ★**

Command assignment for pump 3.

This parameter can be accessed if **[Nb Of Pumps]  $\Pi P P n$**  is set to **[3] 3** or above.

Identical to **[Pump 1 Cmd Assign]  $\Pi P 0 1$**  (*see page 235*).

**[Pump 3 Ready Assign]  $\Pi P , 3$  ★**

Pump 3 ready to operate assignment.

This parameter can be accessed if **[Nb Of Pumps]  $\Pi P P n$**  is set to **[3] 3** or above.

Identical to **[Pump 1 Ready Assign]  $\Pi P , 1$**  (*see page 236*).

**[Pump 4 Cmd Assign]  $\Pi P 0 4$  ★**

Command assignment for pump 4.

This parameter can be accessed if **[Nb Of Pumps]  $\Pi P P n$**  is set to **[4] 4** or above.

Identical to **[Pump 1 Cmd Assign]  $\Pi P 0 1$**  (*see page 235*).

**[Pump 4 Ready Assign]  $\Pi P , 4$  ★**

Pump 4 ready to operate assignment.

This parameter can be accessed if **[Nb Of Pumps]  $\Pi P P n$**  is set to **[4] 4** or above.

Identical to **[Pump 1 Ready Assign]  $\Pi P , 1$**  (*see page 236*).

**[Pump 5 Cmd Assign]  $\Pi P \square 5$  ★**

Command assignment for pump 5.

This parameter can be accessed if **[Nb Of Pumps]  $\Pi P P n$**  is set to **[5] 5** or above.

Identical to **[Pump 1 Cmd Assign]  $\Pi P \square 1$**  (*see page 235*).

**[Pump 5 Ready Assign]  $\Pi P , 5$  ★**

Pump 5 ready to operate assignment.

This parameter can be accessed if **[Nb Of Pumps]  $\Pi P P n$**  is set to **[5] 5** or above.

Identical to **[Pump 1 Ready Assign]  $\Pi P , 1$**  (*see page 236*).

**[Pump 6 Cmd Assign]  $\Pi P \square 6$  ★**

Command assignment for pump 6.

This parameter can be accessed if **[Nb Of Pumps]  $\Pi P P n$**  is set to **[6] 6** or above.

Identical to **[Pump 1 Cmd Assign]  $\Pi P \square 1$**  (*see page 235*).

**[Pump 6 Ready Assign]  $\Pi P , 6$  ★**

Pump 6 ready to operate assignment.

This parameter can be accessed if **[Nb Of Pumps]  $\Pi P P n$**  is set to **[6] 6** or above.

Identical to **[Pump 1 Ready Assign]  $\Pi P , 1$**  (*see page 236*).

**[System Architecture] ПР9 - Menu**

**Access**

[Complete settings] → [Generic functions] → [Booster control] → [System architecture]

**[Pump Cycling Mode] ПРРС**

Pump cycling mode.

Setting	Code / Value	Description
[FIFO]	F , F 0	First in first out
[LIFO]	L , F 0	Last in first out <b>Factory setting</b>
[Runtime]	r t , П E	Pump runtime

**[Lead Pump Alternation] ПРЛН**

Lead pump alternation.

This parameter can be accessed if [Pump System Archi] ПР5Н is set to [Single Drive] V n d o L

**NOTE:** If [Lead Pump Alternation] ПРЛН is not set to [No] n o , the [Pump 1 Cmd Assign] ПР0 I and [Pump 1 Ready Assign] ПР , I have to be configured.

Setting	Code / Value	Description
[No]	n o	Deactivated <b>Factory setting</b>
[Stage]	S t A G E	Lead pump permutation at each stage

**[Altern Wait Time] ПРНt**

Alternation wait time.

Setting	Description
0...999 ms	Setting range <b>Factory setting:</b> 500 ms

**[Pump Auto Cycling] ПРСП**

Pump auto cycling.

This parameter can be accessed if [Pump System Architecture] ПР5Н is set to [Single Drive] V n d o L .

Setting	Description
0.0...24.0 h	Setting range <b>Factory setting:</b> 0.0 h

**[Pump Ready Delay] ПР , d**

Pump ready delay.

It corresponds to the stop time of the pumps. The pumps are considered as in running state and can not be staged during this delay, whatever the active command channel.

Setting	Description
0...3600 s	Setting range <b>Factory setting:</b> 0 s

**[MultiPump ErrorResp] П P F б**

Response to multipump error.

This parameter can be accessed if **[Pump System Archi] П P S A** is set to **[Single Drive] V n d o L**

Setting	Code / Value	Description
<b>[Ignore]</b>	<i>n o</i>	Detected error ignored
<b>[Freewheel Stop]</b>	<i>Y E S</i>	Freewheel stop <b>Factory setting</b>
<b>[Per STT]</b>	<i>S t t</i>	Stop according to <b>[Type of stop] S t t</b> parameter but without an error triggered after stop
<b>[Ramp stop]</b>	<i>r P P</i>	Stop on ramp

**[Booster control] б S C - Menu****Access**

**[Complete settings] → [Generic functions] → [Booster control] → [Booster control]**

**About This Menu**

This menu is used to set the booster control parameters.

**[Booster Control] б C П**

Booster control activation.

Setting	Code / Value	Description
<b>[No]</b>	<i>n o</i>	Booster control function disabled <b>Factory setting</b>
<b>[Yes]</b>	<i>Y E S</i>	Booster control function enabled

[Stage/Destage condition] *5 d C Π* - Menu

Access

[Complete settings] → [Generic functions] → [Booster control] → [Booster control] → [Stage/Destage condition]

Staging/Destaging on Pressure Feedback Condition

- The working area [Booster Working Range] *b C W R* is expressed in a % of the reference value for the pressure.
- Staging occurs if PID error (taking into account [PID Inversion] *P i C*) stays below the working area while PID controller is at high limit speed for longer than [Booster Stg Delay] *b S d*. High limit speed corresponds to limitation speed of PID (minimum between [High Speed] *H S P* & [PID Max Output] *P o H*).
- De-staging occurs if PID error (taking into account [PID Inversion] *P i C*) stays above working area while PID controller is at low limit speed, for longer than [Booster Dstg Delay] *b d d*. Low limit speed corresponds to speed at which PID controller has no effect (maximum between [Low Speed] *L S P* & [PID Min Output] *P o L*).

Staging/Destaging on Override

The override area is used whatever the configuration of the system and the strategy used. If the pressure feedback is out of the [Booster Override Range] *b C o R* range, expressed in % of the reference value for the pressure, a staging/de-staging is immediate. This increases the reactivity of the system in case of an important and rapid variation of the demand. It allows suppressing the staging/de-staging delay.

[Booster Working Range] *b C W R* ★

Booster working area in % of the reference value for the pressure.

Setting ( )	Description
1.0...100.0%	Setting range in % of the reference value for the pressure Factory setting: 2.0%

[Booster Stg Delay] *b S d*

Booster stage delay.

Setting ( )	Description
0.0...999.9 s	Setting range Factory setting: 10.0 s

[Booster Dstg Delay] *b d d*

Booster de-stage delay.

Setting ( )	Description
0.0...999.9 s	Setting range Factory setting: 10.0 s

[Booster Override Range] *b C o R*

Booster override range.

Setting ( )	Code / Value	Description
[No]	<i>n o</i>	Booster override range disabled Factory setting
0.1...100.0%		Setting range



**[Booster control] b 5 C - Menu****Access**

[Complete settings] → [Generic functions] → [Booster control] → [Booster control]

**[Booster S/D Interval] b 5 d t**

Booster stage/de-stage time interval.

Setting ( )	Description
0.0...999.9 s	Setting range <b>Factory setting:</b> 15.0 s

## Section 6.20

### [Generic monitoring]

---

#### What Is in This Section?

This section contains the following topics:

Topic	Page
[Stall monitoring] <i>SP</i> - Menu	243
[Therm sensor monit] <i>SP</i> - Menu	244

## [Stall monitoring] 5 Ƨ P Ʀ - Menu

### Access

[Complete settings] → [Generic monitoring] → [Stall monitoring]

### About This Menu

This function helps to prevent a motor overload by monitoring the motor current and the speed rise time.

A stalling condition is when:

- An output frequency is smaller than the stalling frequency [Stall Frequency] 5 Ƨ P Ƴ
- And an output current is higher than the stalling current [Stall Current] 5 Ƨ P Ƴ
- During a time longer than the stalling time [Stall Max Time] 5 Ƨ P 1

When a stalling condition occurs, a [Motor Stall Error] 5 Ƨ F error is triggered.

### [Stall Monitoring] 5 Ƨ P Ƨ

Stall monitoring activation.

Setting	Code / Value	Description
[No]	n 0	Function disabled <b>Factory setting</b>
[Yes]	y E 5	Function enabled

### [Stall Max Time] 5 Ƨ P 1★

Motor stall maximum time.

This parameter can be accessed if [Stall Monitoring] 5 Ƨ P Ƨ is not set to [No] n 0.

Setting ( )	Description
0.0...200 s	Setting range <b>Factory setting:</b> 60.0 s

### [Stall Current] 5 Ƨ P Ƴ★

Stall monitoring current level, as a % of the rated motor current [Nom Motor Current] n Ƨ r .

This parameter can be accessed if [Stall Monitoring] 5 Ƨ P Ƨ is not set to [No] n 0.

The factory setting changes to 150.0 % if [Dual rating] d r Ƨ is set to [Heavy Duty] H i Ƨ h .

The setting range changes to 0.0...150.0 % if [Dual rating] d r Ƨ is set to [Heavy Duty] H i Ƨ h .

Setting ( )	Description
0.0...120.0%	Setting range <b>Factory setting:</b> 110.0%

### [Stall Frequency] 5 Ƨ P Ƴ★

Stall monitoring frequency level.

This parameter can be accessed if [Stall Monitoring] 5 Ƨ P Ƨ is not set to [No] n 0.

Setting ( )	Description
0.0...20.0 Hz	Setting range <b>Factory setting:</b> 0.0 Hz

## [Therm sensor monit] П E S P - Menu

### Access

[Complete settings] → [Generic monitoring] → [Therm sensor monit]

### About This Menu

The thermal monitoring function helps to prevent against high temperature by monitoring the real temperature by the drive.

PTC, PT100, PT1000, and KTY84 thermal probes are supported by this function.

The function gives the possibility to manage 2 levels of monitoring:

- A Warning level: the drive triggers an event without stopping the application.
- An Error level: the drive triggers an event and stops the application.

The thermal probe is monitored for the following detected error:

- Overheating
- Probe break (loss of signal)
- Probe short-circuit

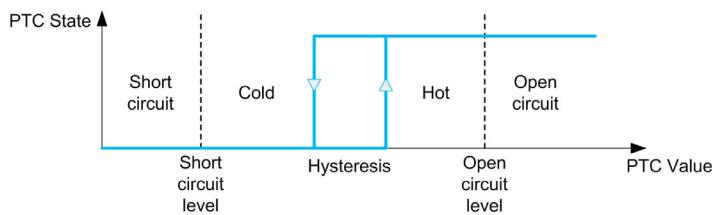

### Activation

[Alx Th Monitoring] E H X S allows you to activate the thermal monitoring on the related analog input:

- [No] n o: the function is disabled
- [Yes] Y E S: the thermal monitoring is enabled on the related Alx.

### Type of Thermal Probe Selection

[Alx Type] A , X E allows you to select the type of thermal sensor(s) connected on the related analog input:

- [No] n o: no sensor
- [PTC Management] P E e: one to six PTC (in serial) is used
- [KTY] K E y: 1 KTY84 is used
- [PT100] I P E e: 1 PT100 connected with two wires is used
- [PT1000] I P E e: 1 PT1000 connected with two wires is used
- [PT100 in 3 wires] I P E e e: 1 PT100 connected with three wires is used (AI4 & AI5 only)
- [PT1000 in 3 wires] I P E e e: 1 PT1000 connected with three wires is used (AI4 & AI5 only)
- [3 PT100] e P E e: 3 PT100 connected with two wires is used
- [3 PT1000] e P E e: 3 PT1000 connected with two wires is used
- [3 PT100 in 3 wires] e P E e e: 3 PT100 connected with three wires is used (AI4 & AI5 only)
- [3 PT1000 in 3 wires] e P E e e: 3 PT1000 connected with three wires is used (AI4 & AI5 only)

2-wire thermal probes are supported on analog input 2 to analog input 5.

3-wire thermal probes are supported on analog input 4 and analog input 5. These inputs are available with the I/O extension option module.

If the probe is far from the drive, the 3-wire connection is recommended as compared to a 2-wire connection.

**NOTE:** In case of 3 serial probes, the drive monitors the average probe values.

### Wiring for PT100 and PT1000 Probes

For 2-wire probes, the following wirings are possible:

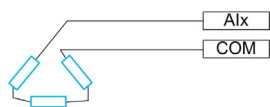

For 3-wire probes, the following wirings are possible:

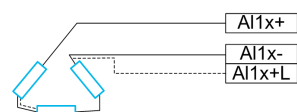
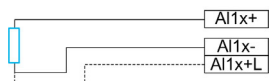

### [AI2 Th Monitoring] Ɛ H 2 5

Activation of the thermal monitoring on AI2.

Setting	Code / Value	Description
[No]	n o	No Factory setting
[YES]	Y E 5	Yes

### [AI2 Type] R , 2 Ɛ ★

AI2 assignment.

This parameter can be accessed if [AI2 Th Monitoring] Ɛ H 2 5 is not set to [No] n o.

Setting	Code / Value	Description
[Voltage]	1 0 v	0-10 Vdc
[Current]	0 R	0-20 mA Factory setting
[KTY]	K Ɛ Ƴ	1 KTY84 This selection can be accessed if [AIx Th Monitoring] Ɛ H X 5 is not set to [No] n o
[PT1000]	1 P Ɛ 3	1 PT1000 connected with 2 wires This selection can be accessed if [AIx Th Monitoring] Ɛ H X 5 is not set to [No] n o
[PT100]	1 P Ɛ 2	1 PT100 connected with 2 wires This selection can be accessed if [AIx Th Monitoring] Ɛ H X 5 is not set to [No] n o
[3PT1000]	3 P Ɛ 3	3 PT1000 connected with 2 wires This selection can be accessed if [AIx Th Monitoring] Ɛ H X 5 is not set to [No] n o
[3PT100]	3 P Ɛ 2	3 PT100 connected with 2 wires This selection can be accessed if [AIx Th Monitoring] Ɛ H X 5 is not set to [No] n o

**[AI2 Th Error Resp] E H 2 B ★**

Thermal monitoring response to a detected error for AI2.

This parameter can be accessed if [AI2 Type] R , 2 E is not set to

- [Voltage] I D u , or
- [Current] D R .

Setting	Code / Value	Description
[Ignore]	n o	Detected error ignored
[Freewheel Stop]	4 E 5	Freewheel stop
[Per STT]	5 E E	Stop according to [Type of stop] 5 E E parameter but without an error triggered after stop
[Fallback Speed]	L F F	Change to fallback speed, maintained as long as the detected error persists and the command has not been removed <sup>(1)</sup>
[Ramp stop]	r P P	Stop on ramp <b>Factory setting</b>
<p><b>1</b> Because, in this case, the detected error does not trigger a stop, it is recommended to assign a relay or logic output to its indication.</p>		

**[AI2 Th Error Level] E H 2 F ★**

Error detection level for AI2.

This parameter can be accessed if [AI2 Type] R , 2 E is not set to:

- [Voltage] I D u , or
- [Current] D R , or
- [PTC Management] P E C .

Setting ( )	Description
-15.0...200.0°C	Setting range <b>Factory setting:</b> 110.0°C

**[AI2 Th Warn Level] E H 2 A ★**

Warning level for AI2.

This parameter can be accessed if [AI2 Type] R , 2 E is not set to:

- [Voltage] I D u , or
- [Current] D R , or
- [PTC Management] P E C .

Setting ( )	Description
-15.0...200.0°C	Setting range <b>Factory setting:</b> 90.0°C

**[AI2 Th Value] E H 2 V ★**

AI2 thermal value.

This parameter can be accessed if [AI2 Type] R , 2 E is not set to:

- [Voltage] I D u , or
- [Current] D R , or
- [PTC Management] P E C .

Setting	Description
-15.0...200.0°C	Setting range <b>Factory setting:</b> _

**[AI3 Th Monitoring] E H 3 5**

Activation of the thermal monitoring on AI3.

Setting	Code / Value	Description
[No]	n o	No <b>Factory setting</b>
[YES]	Y E 5	Yes

**[AI3 Type] R , 3 E ★**

AI3 assignment.

This parameter can be accessed if **[AI3 Th Monitoring] E H 3 5** is not set to **[No] n o**.

Identical to **[AI2 Type] R , 2 E** (*see page 245*).

**[AI3 Th Error Resp] E H 3 6 ★**

Thermal monitoring response to a detected error for AI3.

This parameter can be accessed if **[AI3 Type] R , 3 E** is not set to:

- **[Voltage] I D u**, or
- **[Current] D R**, or

Setting	Code / Value	Description
[Ignore]	n o	Detected error ignored
[Freewheel Stop]	Y E 5	Freewheel stop
[Per STT]	S E E	Stop according to <b>[Type of stop] S E E</b> parameter but without an error triggered after stop
[Fallback Speed]	L F F	Change to fallback speed, maintained as long as the detected error persists and the command has not been removed <sup>(1)</sup>
[Ramp stop]	r P P	Stop on ramp <b>Factory setting</b>
<b>1</b> Because, in this case, the detected error does not trigger a stop, it is recommended to assign a relay or logic output to its indication.		

**[AI3 Th Error Level] E H 3 F ★**

Error detection level for AI3.

This parameter can be accessed if **[AI3 Type] R , 3 E** is not set to:

- **[Voltage] I D u**, or
- **[Current] D R**, or
- **[PTC Management] P E C**.

Setting (°)	Description
-15.0...200.0°C	Setting range <b>Factory setting:</b> 110.0°C

**[AI3 Th Warn Level] E H 3 R ★**

Warning level for AI3.

This parameter can be accessed if **[AI3 Type] R , 3 E** is not set to:

- **[Voltage] I D u**, or
- **[Current] D R**, or
- **[PTC Management] P E C**.

Setting (°)	Description
-15.0...200.0°C	Setting range <b>Factory setting:</b> 90.0°C

**[AI3 Th Value] E H 3 V ★**

AI3 thermal value.

This parameter can be accessed if **[AI3 Type] R , 3 E** is not set to:

- **[Voltage] I D U**, or
- **[Current] D R**, or
- **[PTC Management] P E C**.

Setting	Description
-15.0...200.0°C	Setting range <b>Factory setting:</b> _

**[AI4 Th Monitoring] E H 4 5 ★**

Activation of the thermal monitoring on AI4.

This parameter can be accessed if VW3A3203 I/O extension module has been inserted.

Setting	Code / Value	Description
<b>[No]</b>	n o	No <b>Factory setting</b>
<b>[YES]</b>	Y E 5	Yes

**[AI4 Th Error Resp] E H 4 6 ★**

Thermal monitoring response to a detected error for AI4.

This parameter can be accessed if **[AI4 Type] R , 4 E** is not set to

- **[Voltage] I D U**, or
- **[Current] D R**.

Setting	Code / Value	Description
<b>[Ignore]</b>	n o	Detected error ignored
<b>[Freewheel Stop]</b>	Y E 5	Freewheel stop
<b>[Per STT]</b>	S E E	Stop according to <b>[Type of stop] S E E</b> parameter but without an error triggered after stop
<b>[Fallback Speed]</b>	L F F	Change to fallback speed, maintained as long as the detected error persists and the command has not been removed <sup>(1)</sup>
<b>[Ramp stop]</b>	r P P	Stop on ramp <b>Factory setting</b>
<b>1</b> Because, in this case, the detected error does not trigger a stop, it is recommended to assign a relay or logic output to its indication.		

**[AI4 Th Error Level] E H 4 F ★**

Error detection level for AI4.

This parameter can be accessed if **[AI4 Type] R , 4 E** is not set to:

- **[Voltage] I D U**, or
- **[Current] D R**, or
- **[PTC Management] P E C**.

Setting (°)	Description
-15.0...200.0°C	Setting range <b>Factory setting:</b> 110.0°C



**[AI4 Th Warn Level] E H 4 R ★**

Warning level for AI4.

This parameter can be accessed if **[AI4 Type] R , 4 E** is not set to:

- **[Voltage] I D U**, or
- **[Current] D R**, or
- **[PTC Management] P E L**.

Setting ( )	Description
-15.0...200.0°C	Setting range <b>Factory setting:</b> 90.0°C

**[AI4 Th Value] E H 4 V ★**

AI4 thermal value.

This parameter can be accessed if **[AI4 Type] R , 4 E** is not set to:

- **[Voltage] I D U**, or
- **[Current] D R**, or
- **[PTC Management] P E L**.

Setting	Description
-15.0...200.0°C	Setting range <b>Factory setting:</b> _

**[AI5 Th Monitoring] E H 5 S ★**

Activation of the thermal monitoring on AI5.

This parameter can be accessed if VW3A3203 I/O extension module has been inserted.

Setting	Code / Value	Description
<b>[No]</b>	n o	No <b>Factory setting</b>
<b>[YES]</b>	y e s	Yes

**[AI5 Th Error Resp] E H 5 b ★**

Thermal monitoring response to a detected error for AI5.

This parameter can be accessed if **[AI5 Type] R , 5 E** is not set to

- **[Voltage] I D U**, or
- **[Current] D R**.

Setting	Code / Value	Description
<b>[Ignore]</b>	n o	Detected error ignored
<b>[Freewheel Stop]</b>	y e s	Freewheel stop
<b>[Per STT]</b>	s e t	Stop according to <b>[Type of stop] S E E</b> parameter but without an error triggered after stop
<b>[Fallback Speed]</b>	l f f	Change to fallback speed, maintained as long as the detected error persists and the command has not been removed <sup>(1)</sup>
<b>[Ramp stop]</b>	r a m p	Stop on ramp <b>Factory setting</b>

**1** Because, in this case, the detected error does not trigger a stop, it is recommended to assign a relay or logic output to its indication.

**[AI5 Th Error Level] E H S F ★**

Error detection level for AI5.

This parameter can be accessed if **[AI5 Type] R , S E** is not set to:

- **[Voltage] I D U**, or
- **[Current] D R**, or
- **[PTC Management] P E L**.

Setting (°)	Description
-15.0...200.0°C	Setting range <b>Factory setting:</b> 110.0°C

**[AI5 Th Warn Level] E H S R ★**

Warning level for AI5.

This parameter can be accessed if **[AI5 Type] R , S E** is not set to:

- **[Voltage] I D U**, or
- **[Current] D R**, or
- **[PTC Management] P E L**.

Setting (°)	Description
-15.0...200.0°C	Setting range <b>Factory setting:</b> 90.0°C

**[AI5 Th Value] E H S V ★**

AI5 thermal value.

This parameter can be accessed if **[AI5 Type] R , S E** is not set to:

- **[Voltage] I D U**, or
- **[Current] D R**, or
- **[PTC Management] P E L**.

Setting	Description
-15.0...200.0°C	Setting range <b>Factory setting:</b> _

## Section 6.21

### [Error/Warning handling]

#### What Is in This Section?

This section contains the following topics:

Topic	Page
[Fault reset] <i>r 5 t</i> - Menu	252
[Auto fault reset] <i>R t r</i> - Menu	254
[Catch on the fly] <i>F L r</i> - Menu	255
[Motor thermal monit] <i>t H t</i> - Menu	256
[Output phase loss] <i>o P L</i> - Menu	258
[Input phase loss] <i>i P L</i> - Menu	258
[External error] <i>E t F</i> - Menu	259
[Undervoltage handling] <i>u 5 b</i> - Menu	260
[Ground Fault] <i>G r F L</i> - Menu	262
[4-20mA loss] <i>L F L</i> - Menu	263
[Fallback Speed] <i>L F F</i> - Menu	264
[Error detection disable] <i>i n H</i> - Menu	265
[Fieldbus monitoring] <i>C L L</i> - Menu	266
[Communication module] <i>C o m o</i> - Menu	267
[Error/Warning handling] <i>C S w n</i> - Menu	268
[Process underload] <i>u L d</i> - Menu	269
[Process overload] <i>o L d</i> - Menu	271
[Warn grp 1 definition] <i>R 1 C</i> - Menu	273
[Warn grp 2 definition] <i>R 2 C</i> - Menu	273
[Warn grp 3 definition] <i>R 3 C</i> - Menu	273
[Warn grp 4 definition] <i>R 4 C</i> - Menu	273
[Warn grp 5 definition] <i>R 5 C</i> - Menu	273

**[Fault reset] r 5 E - Menu**

**Access**

[Complete settings] → [Error/Warning handling] → [Fault reset]

**[Fault Reset Assign] r 5 F**

Fault reset input assignment.

Detected errors are cleared manually when the assigned input or bit changes to 1 if the cause of the detected error has been removed.

All errors cannot be cleared via a Fault Reset. Refer to the table in the part Diagnostics and Troubleshooting to have the full list (see page 307).

The STOP/RESET key on the Plain Text Display Terminal performs the same function.

Setting	Code / Value	Description
[Not Assigned]	n 0	Not assigned
[DI1]...[DI6]	L , 1 1...L , 1 6	Digital input DI1...DI6 <b>Factory setting:</b> [DI4] L , 4. The setting of this parameter may be modified depending on [Macro Config] C F G (see page 38)
[DI11]...[DI16]	L , 1 1 1...L , 1 1 6	Digital input DI11...DI16 if VW3A3203 I/O extension module has been inserted
[CD00]...[CD10]	C d 0 0...C d 1 0	Virtual digital input CMD.0...CMD.10 in [I/O profile] , 0 configuration
[CD11]...[CD15]	C d 1 1...C d 1 5	Virtual digital input CMD.11...CMD.15 regardless of configuration
[C101]...[C110]	C 1 0 1...C 1 1 0	Virtual digital input CMD1.01...CMD1.10 with integrated Modbus Serial in [I/O profile] , 0 configuration
[C111]...[C115]	C 1 1 1...C 1 1 5	Virtual digital input CMD1.11...CMD1.15 with integrated Modbus Serial regardless of configuration
[C301]...[C310]	C 3 0 1...C 3 1 0	Virtual digital input CMD3.01...CMD3.10 with a fieldbus module in [I/O profile] , 0 configuration
[C311]...[C315]	C 3 1 1...C 3 1 5	Virtual digital input CMD3.11...CMD3.15 with a fieldbus module regardless of configuration
[C501]...[C510]	C 5 0 1...C 5 1 0	Virtual digital input CMD5.01...CMD5.10 with integrated Ethernet in [I/O profile] , 0 configuration
[C511]...[C515]	C 5 1 1...C 5 1 5	Virtual digital input CMD5.11...CMD5.15 with integrated Ethernet regardless of configuration

**[Prod Restart Assign]** *r P R* ★ ⏳

Product restart assignment.

The Restart function performs a Fault Reset and then restarts the drive. During this Restart procedure, the drive goes through the same steps as if it had been switched off and on again. Depending on the wiring and the configuration of the drive, this may result in immediate and unanticipated operation. The Restart function can be assigned to a digital input

**⚠ WARNING****UNANTICIPATED EQUIPMENT OPERATION**

The Restart function performs a Fault Reset and restarts the drive

- Verify that activating this function does not result in unsafe conditions.

**Failure to follow these instructions can result in death, serious injury, or equipment damage.**

This parameter can be accessed if **[Access Level]** *L A C* is set to **[Expert]** *E P r* mode.

Setting	Code / Value	Description
<b>[Not Assigned]</b>	<i>n o</i>	Not assigned <b>Factory setting</b>
<b>[DI1]...[DI6]</b>	<i>L , 1...L , 6</i>	Digital input DI1...DI6
<b>[DI11]...[DI16]</b>	<i>L , 11...L , 16</i>	Digital input DI11...DI16 if VW3A3203 I/O extension module has been inserted

**[Product Restart]** *r P* ★

The Restart function performs a Fault Reset and then restarts the drive. During this Restart procedure, the drive goes through the same steps as if it had been switched off and on again. Depending on the wiring and the configuration of the drive, this may result in immediate and unanticipated operation.

**⚠ WARNING****UNANTICIPATED EQUIPMENT OPERATION**

The Restart function performs a Fault Reset and restarts the drive

- Verify that activating this function does not result in unsafe conditions.

**Failure to follow these instructions can result in death, serious injury, or equipment damage.**

Product restart.

This parameter can be accessed if **[Access Level]** *L A C* is set to **[Expert]** *E P r* mode.

This parameter can be used to reset all detected errors without having to disconnect the drive from the supply mains.

Setting	Code / Value	Description
<b>[No]</b>	<i>n o</i>	Function inactive <b>Factory setting</b>
<b>[Yes]</b>	<i>Y E 5</i>	Reinitialization. Press and hold down the OK key for 2 s. The parameter changes back to <b>[No]</b> <i>n o</i> automatically as soon as the operation is complete. The drive can only be reinitialized when locked.

[Auto fault reset] *F E r* - Menu

Access

[Complete settings] → [Error/Warning handling] → [Auto fault reset]

[Auto Fault Reset] *F E r* 

Automatic fault reset.

This function can be used to automatically perform individual or multiple Fault Resets. If the cause of the error that has triggered the transition to the operating state Fault disappears while this function is active, the drive resumes normal operation. While the Fault Reset attempts are performed automatically, the output signal [Operating state Fault] is not available. If the attempts to perform the Fault Reset are not successful, the drive remains in the operating state Fault and the output signal [Operating state Fault] becomes active.

<b> WARNING</b>
<b>UNANTICIPATED EQUIPMENT OPERATION</b>
<ul style="list-style-type: none"> <li>• Verify that activating this function does not result in unsafe conditions.</li> <li>• Verify that the fact that the output signal "Operating state Fault" is not available while this function is active does not result in unsafe conditions.</li> </ul>
<b>Failure to follow these instructions can result in death, serious injury, or equipment damage.</b>

The drive fault relay remains activated if this function is active. The speed reference and the operating direction must be maintained.

It is recommended to use 2-wire control ([2/3-wire control] *E C C* is set to [2 wire] *2 C* and [2-wire type] *E C E* is set to [Level] *L E L*, refer to [2/3-wire control] *E C C*.

If the restart has not taken place once the configurable time [Fault Reset Time] *E F r* has elapsed, the procedure is aborted and the response to external error. remains locked until it is turned off and then on again.

The detected error codes, which permit this function, are listed in the Diagnostics part of the manual.

Setting	Code / Value	Description
[No]	<i>n 0</i>	Function inactive <b>Factory setting</b>
[Yes]	<i>Y E 5</i>	Automatic restart, after locking in error state, if the detected error has disappeared and the other operating conditions permit the restart. The restart is performed by a series of automatic attempts separated by increasingly longer waiting periods: 1 s, 5 s, 10 s, then 1 minute for the following attempts.

[Fault Reset Time] *E F r* ★

Maximum time for automatic restart function.

This parameter appears if [Auto Fault Reset] *F E r* is set to [Yes] *Y E 5*. It can be used to limit the number of consecutive restarts on a recurrent detected error.

Setting	Code / Value	Description
[5 minutes]	<i>5</i>	5 minutes <b>Factory setting</b>
[10 minutes]	<i>1 0</i>	10 minutes
[30 minutes]	<i>3 0</i>	30 minutes
[1 hour]	<i>1 h</i>	1 hour
[2 hours]	<i>2 h</i>	2 hours
[3 hours]	<i>3 h</i>	3 hours
[Unlimited]	<i>C E</i>	Continuous

## [Catch on the fly] $F L r$ - Menu

### Access

[Complete settings] → [Error/Warning handling] → [Catch on the fly]

### [Catch On Fly] $F L r$

Catch on the fly.

Used to enable a smooth restart if the run command is maintained after the following events:

- Loss of line supply or disconnection.
- Clearing clearance of current detected error or automatic restart.
- Freewheel stop.

The speed given by the drive resumes from the estimated or measured speed of the motor at the time of the restart, then follows the ramp to the reference speed.

This function requires 2-wire level control.

When the function is operational, it activates at each run command, resulting in a slight delay of the current (0.5 s max).

[Catch On Fly]  $F L r$  is forced to [No]  $n o$  if [Auto DC Injection]  $R d C$  is set to [Continuous]  $C E$ .

Setting	Code / Value	Description
[Not Configured]	$n o$	Function inactive. <b>Factory setting</b>
[Yes On Freewheel]	$Y E S$	Function active only after freewheel stop.

### [Catch on Fly Sensitivity] $V L b$ ★

Catch on fly sensitivity.

Setting the value of parameter [Catch on Fly Sensitivity]  $V L b$  too low may cause a wrong estimation of the speed of the motor.

## ⚠ WARNING

### LOSS OF CONTROL

- Only reduce gradually the value of parameter [Catch on Fly Sensitivity]  $V L b$ .
- During commissioning, verify that the drive and the system operate as intended by performing tests and simulations in a controlled environment under controlled conditions

**Failure to follow these instructions can result in death, serious injury, or equipment damage.**

Setting	Description
0.10...100.00 V	Setting range <b>Factory setting:</b> 0.20 V

## [Motor thermal monit] E H E - Menu

### Access

[Complete settings] → [Error/Warning handling] → [Motor thermal monit]

### About this Menu

Motor thermal protection by calculating the  $I^2t$ .

**NOTE:** The motor thermal state is memorized when the drive is switched off. The power-off time is used to calculate the motor thermal state at the next startup.

- Self-cooled motors: The trigger curves depend on the motor frequency.
- Forced-cooled motors: Only the 50 Hz trigger curves needs to be considered, regardless of the motor frequency.

Below a curve for 50Hz motor.

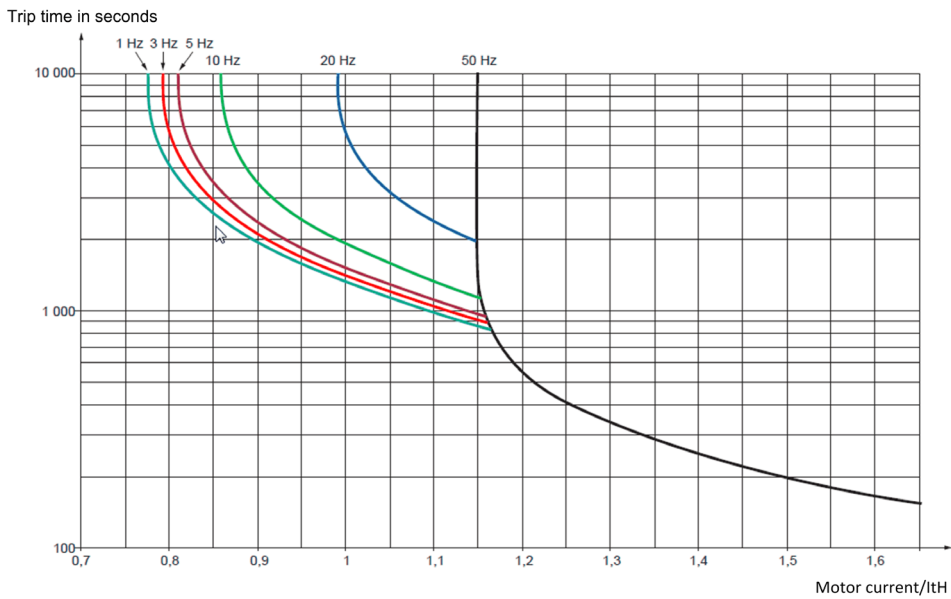

Below a curve for 60Hz motor.

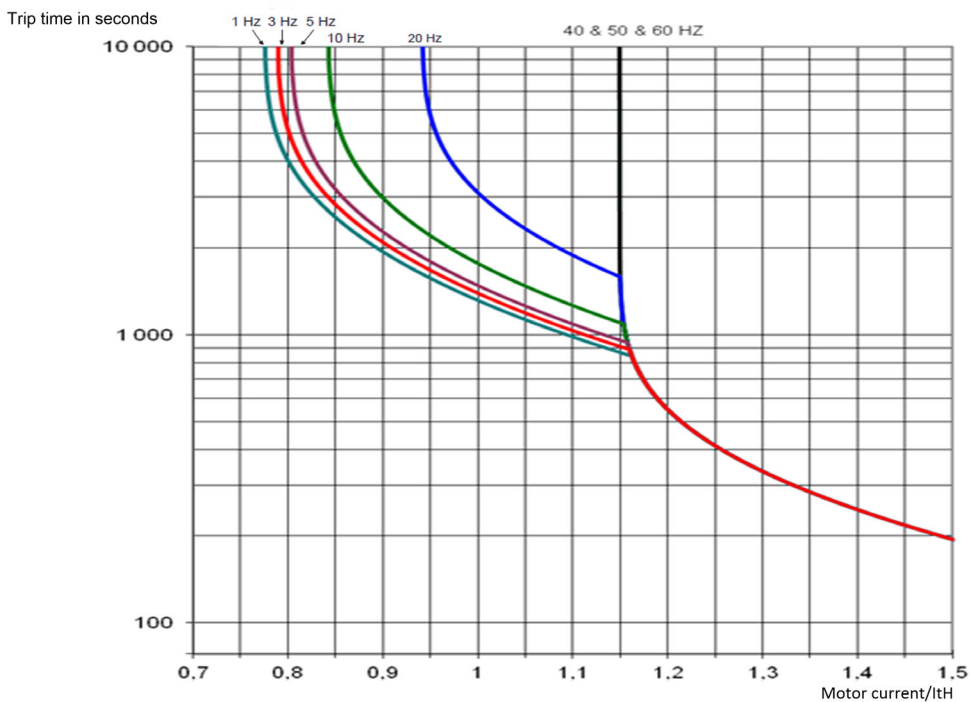



**[Motor Thermal Mode] E H E**

Motor thermal monitoring mode.

**NOTE:** An error is detected when the thermal state reaches 118% of the rated state and reactivation occurs when the state falls back below 100%.

Setting	Code / Value	Description
[No]	n o	No thermal protection
[Self cooled]	A C L	Self ventilated motor <b>Factory setting</b>
[Force-cool]	F C L	Fan-cooled motor

**[Motor Thermal Thd] E E d**

Motor thermal state threshold.

Setting (°)	Description
0...118%	Setting range <b>Factory setting:</b> 100%

**[MotorTemp ErrorResp] o L L**

Overload error response.

Setting	Code / Value	Description
[Ignore]	n o	Detected error ignored
[Freewheel Stop]	Y E S	Free wheel <b>Factory setting</b>



**[Output phase loss]  $\square$  PL - Menu**

**Access**

[Complete settings] → [Error/Warning handling] → [Output phase loss]

**[OutPhaseLoss Assign]  $\square$  PL **

Output phase loss assignment.

  <b>DANGER</b>		
<b>HAZARD OF ELECTRIC SHOCK, EXPLOSION OR ARC FLASH</b>		
If output phase monitoring is disabled, phase loss and, by implication, accidental disconnection of cables, are not detected.		
<ul style="list-style-type: none"> <li>Verify that the setting of this parameter does not result in unsafe conditions.</li> </ul>		
<b>Failure to follow these instructions will result in death or serious injury.</b>		

Setting	Code / Value	Description
[Function Inactive]	$n \square$	Function inactive
[OPF Error Triggered]	$\mathcal{Y} E 5$	Tripping on [OutPhaseLoss Assign] $\square$ PL with freewheel stop <b>Factory setting</b>
[No Error Triggered]	$\square P L$	No detected error triggered, but management of the output voltage in order to avoid an overcurrent when the link with the motor is re-established and catch on the fly performed (even if this function has not been configured). The drive switches to [Output cut] $\square$ SC state after [OutPhL Time] $\square$ dt time. Catch on fly is possible as soon as the drive is in stand by output cut [Output cut] $\square$ SC state.

**[OutPhaseLoss Delay]  $\square$  dt**

Output (motor) phase loss detection time.

Time delay for taking the [OutPhaseLoss Assign]  $\square$  PL detected error into account.

Setting ( )	Description
0.5...10 s	Setting range <b>Factory setting:</b> 0.5 s

**[Input phase loss]  $\square$  PL - Menu**

**Access**

[Complete settings] → [Error/Warning handling] → [Input phase loss]

**[InPhaseLoss Assign]  $\square$  PL  **

Loss of input phase error response.

Setting	Code / Value	Description
[Ignore]	$n \square$	Detected error ignored
[Freewheel Stop]	$\mathcal{Y} E 5$	Freewheel stop <b>Factory setting</b>

**[External error] E E F - Menu****Access**

[Complete settings] → [Error/Warning handling] → [External error]

**[Ext Error Assign] E E F**

External error assignment.

If the assigned bit state is:

- 0: there is no external error.
- 1: there is an external error

Setting	Code / Value	Description
[Not Assigned]	n a	Not assigned <b>Factory setting</b>
[DI1]...[DI6]	L , I ... L , 6	Digital input DI1...DI6
[DI11]...[DI16]	L , I I ... L , 16	Digital input DI11...DI16 if VW3A3203 I/O extension module has been inserted
[CD00]...[CD10]	C d 0 0 ... C d 1 0	Virtual digital input CMD.0...CMD.10 in <b>[I/O profile]</b> , a configuration
[CD11]...[CD15]	C d 1 1 ... C d 1 5	Virtual digital input CMD.11...CMD.15 regardless of configuration
[C101]...[C110]	C 1 0 1 ... C 1 1 0	Virtual digital input CMD1.01...CMD1.10 with integrated Modbus Serial in <b>[I/O profile]</b> , a configuration
[C111]...[C115]	C 1 1 1 ... C 1 1 5	Virtual digital input CMD1.11...CMD1.15 with integrated Modbus Serial regardless of configuration
[C301]...[C310]	C 3 0 1 ... C 3 1 0	Virtual digital input CMD3.01...CMD3.10 with a fieldbus module in <b>[I/O profile]</b> , a configuration
[C311]...[C315]	C 3 1 1 ... C 3 1 5	Virtual digital input CMD3.11...CMD3.15 with a fieldbus module regardless of configuration
[DI1 (Low level)]...[DI6 (Low level)]	L I L ... L 6 L	Digital input DI1...DI6 used at low level

**[Ext Error Resp] E P L**

Drive response to external error.

Type of stop in the event of an external detected error.

Setting	Code / Value	Description
[Ignore]	n a	External detected error ignored
[Freewheel Stop]	Y E 5	Freewheel stop <b>Factory setting</b>
[Per STT]	5 E E	Stop according to configuration of <b>[Type of stop] 5 E E</b> ( <i>see page 152</i> ), without tripping. In this case, the detected error relay does not open and the drive is ready to restart as soon as the detected error disappears, according to the restart conditions of the active command channel (for example, according to <b>[2/3-wire control] E C C</b> and <b>[2-wire type] E C E</b> if control is via the terminals). Configuring a warning for this detected error is recommended (assigned to a digital output, for example) in order to indicate the cause of the stop.
[Fallback speed]	L F F	Change to fallback speed, maintained as long as the detected error persists and the run command has not been removed <sup>(1)</sup>
[Speed maintained]	r L 5	The drive maintains the speed being applied when the detected error occurred, as long as the detected error is active and the run command has not been removed <sup>(1)</sup>
[Ramp stop]	r n P	Stop on ramp
[Fast stop]	F 5 E	Fast stop
[DC Injection]	d C ,	DC injection stop. This type of stop cannot be used with some other functions.

(1) Because, in this case, the detected error does not trigger a stop, it is advisable to assign a relay or digital output to its indication.

**[Undervoltage handling] u 5 b - Menu****Access**

[Complete settings] → [Error/Warning handling] → [Undervoltage handling]

**[Undervoltage Resp] u 5 b**

Response to undervoltage.

Setting	Code / Value	Description
[Error Triggered]	0	The drive triggers an error (the detected error relay assigned to [Operating State Fault] F L E will be opened) <b>Factory setting</b>
[Error Triggered w/o Relay]	1	The drive triggers an error (the detected error relay assigned to [Operating State Fault] F L E remains closed)
[Warning Triggered]	2	The warning and detected error relay remain closed. The warning can be assigned to a digital output or a relay

**[Mains Voltage] u r E 5**

Rated voltage of the mains supply in Vac.

The factory setting value of this parameter depends of drive rating.

Settings	Code / Value	Description
[380 Vac]	3 8 0	380 Vac
[400 Vac]	4 0 0	400 Vac
[415 Vac]	4 1 5	415 Vac <b>Factory setting</b>

**[Undervoltage Level] u 5 L**

Undervoltage level.

The factory setting is determined by the drive voltage rating.

Setting	Description
190...212 Vac	Setting range, according to drive rating <b>Factory setting:</b> According to drive rating

**[UnderVolt Timeout] u 5 t**

Undervoltage timeout.

Setting	Description
0.2...999.9 s	Setting range <b>Factory setting:</b> 0.2 s

**[Stop Type PLoss] 5 t P**

Controlled stop on power loss.

Behavior in the event of the undervoltage prevention level being reached.

Setting	Code / Value	Description
[No]	n 0	No action <b>Factory setting</b>
[DC Maintain]	n n 5	This stop mode uses the inertia of the application to maintain the control block powered, and thus to keep operational I/O state and fieldbus link as long as possible.
[Ramp stop]	r n P	Stop following an adjustable deceleration ramp [Max stop time] 5 t n in order to help to prevent from uncontrolled stop of the application.
[Freewheel Stop]	L n F	Lock (freewheel stop) without triggering an error

**[UnderV. Restart Tm] 5 5 P ★**

Undervoltage restart time.

This parameter can be accessed if **[CtrlStopPLoss] 5 5 P** is set to **[Ramp stop] r P P**.

The time delay before authorizing the restart after a complete stop for **[CtrlStopPLoss] 5 5 P** is set to **[Ramp stop] r P P** if the voltage has returned to normal.

Setting ( )	Description
1.0...999.9 s	Setting range Factory setting: 1.0 s

**[Prevention Level] u P L ★**

Undervoltage prevention level.

This parameter can be accessed if **[CtrlStopPLoss] 5 5 P** is set to **[No] n o**.

The adjustment range and factory setting are determined by the drive voltage rating and the **[Mains Voltage] u r E 5** value.

Setting	Description
212...254 V	Setting range Factory setting: According to drive rating

**[Max Stop Time] 5 5 P ★**

Maximum stop time.

This parameter can be accessed if **[CtrlStopPLoss] 5 5 P** is set to **[Ramp stop] r P P**.

This parameter defines the deceleration ramp time in case of mains loss. During this controlled stop, the drive is powered thanks to the inertia of the application, the motor is in generator mode. It is recommended to verify that the deceleration set is compatible with the application inertia.

Setting ( )	Description
0.01...60.00 s	Setting range Factory setting: 1.00 s

**[DC Bus Maintain Time] 5 5 S ★**

DC bus maintain time.

This parameter can be accessed if **[CtrlStopPLoss] 5 5 P** is set to **[DC Maintain] P P 5**.

Setting ( )	Description
1...9999 s	Setting range Factory setting: 9999 s

## [Ground Fault] *G r F L* - Menu

### Access

[Complete settings] → [Error/Warning handling] → [Ground Fault]

### About This Menu

This menu can be accessed if [Access Level] is set to [Expert] *E P r*

If the internal ground fault detection [Ground Fault] *G r F L* causes unwanted results in your application, it is possible to substitute the internal ground fault detection by an appropriate external ground fault monitoring system. Setting the parameter [Ground Fault] *G r F L* to [ErrorDetect Disable] *i n H* or to a percentage value of the nominal current of the drive disables the internal ground fault detection of the drive or reduces its effectiveness. Therefore, you must install an external ground fault detection system that is able to reliably detect ground faults.

**⚠ DANGER**

**GROUND FAULT MONITORING DISABLED**

- Only set the parameter [Ground Fault] *G r F L* to [ErrorDetect Disable] *i n H* or to a percentage value of the nominal current of the drive after a thorough risk assessment in compliance with all regulations and standards that apply to the device and to the application.
- Implement an alternative, external ground fault monitoring function that allows for an adequate, equivalent response to a ground fault of the drive in compliance with all applicable regulations and standards as well as the risk assessment.
- Commission and test the system with all monitoring functions enabled.
- During commissioning, verify that the alternative, external ground fault detection system properly detects any type of ground faults by performing tests and simulations in a controlled environment under controlled conditions.

**Failure to follow these instructions will result in death or serious injury.**

### [Ground Fault Activation] *G r F L*

Ground fault error response.

**NOTE:** The setting of this parameter is taken into account after a product restart.

Setting	Code / Value	Description
[ErrorDetect Disable]	<i>i n H</i>	Disables error detection
[Yes]	<i>Y E S</i>	Use product internal value. <b>Factory setting</b>
0.0...100.0%	–	Setting range, in % of the drive nominal current

**[4-20mA loss] L F L - Menu****Access**

[Complete settings] → [Error/Warning handling] → [4-20mA loss]

**[AI1 4-20mA Loss] L F L 1**

Response to 4-20mA loss on AI1.

Drive behavior on AI1 4-20 event.

Setting	Code / Value	Description
[Ignore]	<i>n o</i>	Detected error ignored. This is the only possible configuration if <b>[AI1 min. value] C r L 1</b> is not greater than 3 mA <b>Factory setting</b>
[Freewheel]	<i>y e 5</i>	Freewheel stop
[Per STT]	<i>5 t t</i>	Stop according to configuration of <b>[Type of stop] 5 t t</b> , without tripping. In this case, the error relay does not open and the drive is ready to restart as soon as the detected error disappears, according to the restart conditions of the active command channel (for example, according to <b>[2/3-wire control] t c c</b> and <b>[2-wire type] t c t</b> if control is via the terminals). Configuring a warning for this detected error is recommended (assigned to a digital output, for example) in order to indicate the cause of the stop
[fallback spd]	<i>L F F</i>	Change to fallback speed, maintained as long as the detected error persists and the run command has not been removed <sup>(1)</sup>
[Spd maint.]	<i>r L 5</i>	The drive maintains the speed being applied when the detected error occurred, as long as the detected error is active and the run command has not been removed <sup>(1)</sup>
[Ramp stop]	<i>r n P</i>	Stop on ramp
[Fast stop]	<i>F 5 t</i>	Fast stop
[DC injection]	<i>d C i</i>	DC injection stop. This type of stop cannot be used with some other functions

(1) Because, in this case, the detected error does not trigger a stop, it is advisable to assign a relay or digital output to its indication.

**[AI2 4-20mA loss] L F L 2**

Response to 4-20mA loss on AI2.

Drive behavior on AI2 4-20 event.

Identical to **[AI1 4-20mA Loss] L F L 1**

**[AI3 4-20mA loss] L F L 3**

Response to 4-20mA loss on AI3.

Drive behavior on AI3 4-20 event.

Identical to **[AI1 4-20mA Loss] L F L 1**

**[AI4 4-20mA loss] L F L 4 ★**

Response to 4-20mA loss on AI4.

Drive behavior on AI4 4-20 event.

Identical to **[AI1 4-20mA Loss] L F L 1**

This parameter can be accessed if VW3A3203 I/O extension module has been inserted.

**[AI5 4-20mA loss] L F L 5 ★**

Response to 4-20mA loss on AI5.

Drive behavior on AI5 4-20 event.

Identical to **[AI1 4-20mA Loss] L F L 1**

This parameter can be accessed if VW3A3203 I/O extension module has been inserted.

## [Fallback Speed] L F F - Menu

### Access

[Complete settings] → [Error/Warning handling] → [Fallback Speed]

### About This Menu

This menu allows you to set the fallback speed.

Depending on the configuration, the fallback speed is used as:

- A response to a thermal detected error on analog input (*see page 244*)
- A response to 4-20mA loss on Aix (*see page 263*)
- A response to an external detected error (*see page 259*)
- A response to a modbus interruption (*see page 266*)
- A response to a fieldbus module interruption (*see page 267*)

### [Fallback Speed] L F F ★

Fall back speed.

Setting	Description
0.0...500.0 Hz	Setting range <b>Factory setting:</b> 0.0 Hz



**[Error detection disable] , n H - Menu****Access**

[Complete settings] → [Error/Warning handling] → [Error detection disable]

**[ErrorDetect Disabled] , n H ★**

Disable error detection.

In rare cases, the monitoring functions of the drive may be unwanted because they impede the purpose of the application. A typical example is a smoke extractor fan operating as a part of a fire protection system. If a fire occurs, the smoke extractor fan should operate as long as possible, even if, for example, the permissible ambient temperature of the drive is exceeded. In such applications, damage to or destruction of the device may be acceptable as collateral damage, for example, to keep other damage from occurring whose hazard potential is assessed to be more severe.

A parameter is provided to disable certain monitoring functions in such applications so that automatic error detection and automatic error responses of the device are no longer active. You must implement alternative monitoring functions for disabled monitoring functions that allow operators and/or master control systems to adequately respond to conditions which correspond to detected errors. For example, if overtemperature monitoring of the drive is disabled, the drive of a smoke extractor fan may itself cause a fire if errors go undetected. An overtemperature condition can be, for example, signaled in a control room without the drive being stopped immediately and automatically by its internal monitoring functions.

**⚠ DANGER****MONITORING FUNCTIONS DISABLED, NO ERROR DETECTION**

- Only use this parameter after a thorough risk assessment in compliance with all regulations and standards that apply to the device and to the application.
- Implement alternative monitoring functions for disabled monitoring functions that do not trigger automatic error responses of the drive, but allow for adequate, equivalent responses by other means in compliance with all applicable regulations and standards as well as the risk assessment.
- Commission and test the system with the monitoring functions enabled.
- During commissioning, verify that the drive and the system operate as intended by performing tests and simulations in a controlled environment under controlled conditions.

**Failure to follow these instructions will result in death or serious injury.**This parameter can be accessed if [Access Level] *L A C* is set to [Expert] *E P r*.

If the assigned input or bit state is:

- 0: error detection is enabled.
- 1: error detection is disabled.

Current errors are cleared on a rising edge from 0 to 1 of the assigned input or bit.

Detection of following errors can be disabled: CNF, EPF1, EPF2, FWER, INFB, INFD, INFK, INFP, INFR, INFU, LFF1, LFF2, LFF3, LFF4, LFF5, MPLF, OBF, OHF, OLC, OLF, OPF1, OPF2, OSF, PFMF, PGLF, PHF, SLF1, SLF3, SOF, STF, T2CF, T3CF, T4CF, T5CF, TH2F, TH3F, TH4F, TH5F, TJF, TNF, ULF, USF.

Setting	Code / Value	Description
[Not Assigned]	<i>n a</i>	Not assigned <b>Factory setting</b>
[DI1]...[DI6]	<i>L , l ... L , l 6</i>	Digital input DI1...DI6
[DI11]...[DI16]	<i>L , l l ... L , l 6</i>	Digital input DI11...DI16 if VW3A3203 I/O extension module has been inserted
[CD00]...[CD10]	<i>C d 0 0 ... C d 1 0</i>	Virtual digital input CMD.0...CMD.10 in [I/O profile] , a configuration
[CD11]...[CD15]	<i>C d 1 1 ... C d 1 5</i>	Virtual digital input CMD.11...CMD.15 in [I/O profile] , a configuration
[C101]...[C110]	<i>C 1 0 1 ... C 1 1 0</i>	Virtual digital input CMD1.01...CMD1.10 with integrated Modbus Serial in [I/O profile] , a configuration
[C111]...[C115]	<i>C 1 1 1 ... C 1 1 5</i>	Virtual digital input CMD1.11...CMD1.15 with integrated Modbus Serial in [I/O profile] , a configuration
[C301]...[C310]	<i>C 3 0 1 ... C 3 1 0</i>	Virtual digital input CMD3.01...CMD3.10 with a fieldbus module in [I/O profile] , a configuration
[C311]...[C315]	<i>C 3 1 1 ... C 3 1 5</i>	Virtual digital input CMD3.11...CMD3.15 with a fieldbus module in [I/O profile] , a configuration

[Fieldbus monitoring] **L L L - Menu**

Access

[Complete settings] → [Error/Warning handling] → [Fieldbus monitoring]

[Modbus Error Resp] **S L L**

Response to Modbus interruption.

<b>⚠ WARNING</b>
<p><b>LOSS OF CONTROL</b></p> <p>If this parameter is set to <b>n o</b>, Modbus communication monitoring is disabled.</p> <ul style="list-style-type: none"> <li>● Only use this setting after a thorough risk assessment in compliance with all regulations and standards that apply to the device and to the application.</li> <li>● Only use this setting for tests during commissioning.</li> <li>● Verify that communication monitoring has been re-enabled before completing the commissioning procedure and performing the final commissioning test.</li> </ul> <p><b>Failure to follow these instructions can result in death, serious injury, or equipment damage.</b></p>

Behavior of the drive in the event of a communication interruption with integrated Modbus.

Setting	Code / Value	Description
[Ignore]	<b>n o</b>	Detected error ignored
[Freewheel]	<b>y e s</b>	Freewheel stop <b>Factory setting</b>
[Per STT]	<b>S t t</b>	Stop according to configuration of <b>[Type of stop] S t t</b> , without tripping. In this case, the error relay does not open and the drive is ready to restart as soon as the detected error disappears, according to the restart conditions of the active command channel (for example, according to <b>[2/3-wire control] t c c</b> and <b>[2-wire type] t c t</b> if control is via the terminals) <sup>(1)</sup>
[fallback spd]	<b>L F F</b>	Change to fallback speed, maintained as long as the detected error persists and the run command has not been removed <sup>(1)</sup>
[Spd maint.]	<b>r L S</b>	The drive maintains the speed being applied when the detected error occurred, as long as the detected error is active and the run command has not been removed <sup>(1)</sup>
[Ramp stop]	<b>r n p</b>	Stop on ramp
[Fast stop]	<b>F S t</b>	Fast stop
[DC injection]	<b>d c i</b>	DC injection stop. This type of stop cannot be used with some other functions

(1) Because, in this case, the detected error does not trigger a stop, it is advisable to assign a relay or digital output to its indication.

## [Communication module] $\llcorner \square \Pi \square$ - Menu

### Access

[Complete settings] → [Error/Warning handling] → [Communication module]

### [Fieldbus Interrupt Resp] $\llcorner \llcorner \llcorner$

## WARNING

### LOSS OF CONTROL

If this parameter is set to  $n \square$ , fieldbus communication monitoring is disabled.

- Only use this setting after a thorough risk assessment in compliance with all regulations and standards that apply to the device and to the application.
- Only use this setting for tests during commissioning.
- Verify that communication monitoring has been re-enabled before completing the commissioning procedure and performing the final commissioning test.

**Failure to follow these instructions can result in death, serious injury, or equipment damage.**

Response to fieldbus module communication interruption.

Setting	Code / Value	Description
[Ignore]	$n \square$	Detected error ignored
[Freewheel]	$Y E 5$	Freewheel stop <b>Factory setting</b>
[Per STT]	$5 E E$	Stop according to configuration of [Type of stop] $5 E E$ , without tripping. In this case, the error relay does not open and the drive is ready to restart as soon as the detected error disappears, according to the restart conditions of the active command channel (for example, according to [2/3-wire control] $E E E$ and [2-wire type] $E E E$ if control is via the terminals) <sup>(1)</sup>
[fallback spd]	$L F F$	Change to fallback speed, maintained as long as the detected error persists and the run command has not been removed <sup>(1)</sup>
[Spd maint.]	$r L 5$	The drive maintains the speed being applied when the detected error occurred, as long as the detected error is active and the run command has not been removed <sup>(1)</sup>
[Ramp stop]	$r \Pi P$	Stop on ramp
[Fast stop]	$F 5 E$	Fast stop
[DC injection]	$d C \cdot$	DC injection stop. This type of stop cannot be used with some other functions

(1) Because, in this case, the detected error does not trigger a stop, it is advisable to assign a relay or digital output to its indication.

**[Error/Warning handling] ESWP - Menu****Access**

[Complete settings] → [Error/Warning handling]

**[Tuning Error Resp] ENL ★**

Response to autotune error.

This parameter can be accessed if [Access Level] LFL is set to [Expert] EPr.

Setting	Code / Value	Description
[Ignore]	no	Detected error ignored
[Freewheel]	YES	Freewheel stop <b>Factory setting</b>

## [Process underload] $\cup L d$ - Menu

### Access

[Complete settings] → [Error/Warning handling] → [Process underload]

### Process Underload Detected Error

A process underload is detected when the next event occurs and remains pending for a minimum time [Unld T. Del. Detect]  $\cup L t$ , which is configurable:

- The motor is in steady state and the torque is below the set underload limit ([Unld.Thr.0.Speed]  $L \cup L$ , [Unld.Thr.Nom.Speed]  $L \cup n$ , [Unld. FreqThr. Det.]  $r \Pi \cup d$  parameters).
- The motor is in steady state when the offset between the frequency reference and motor frequency falls below the configurable threshold [Hysteresis Freq]  $S r b$ .

Between zero frequency and the rated frequency, the curve reflects the following equation: torque =  $L \cup L + (L \cup n - L \cup L) \times (\text{frequency})^2 / (\text{rated frequency})^2$ . The underload function is not active for frequencies below  $r \Pi \cup d$ .

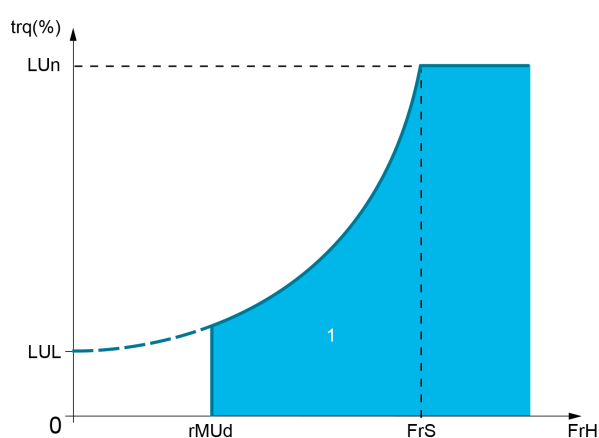

1 Underload zone.

A relay or a digital output can be assigned to the signaling of this detected error in the [Input/Output]  $i o$ , [I/O assignment]  $i o R 5$  - menus.

### [Unld T. Del. Detect] $\cup L t$

Underload detection time delay.

A value of 0 deactivates the function and makes the other parameters inaccessible.

Setting	Description
0...100 s	Setting range Factory setting: 0 s

### [Unld.Thr.Nom.Speed] $L \cup n$ ★

Underload threshold at nominal motor speed [Nominal Motor Freq]  $F r S$ , as a % of the rated motor torque.

This parameter can be accessed if [Unld T. Del. Detect]  $\cup L t$  is not set to 0.

Setting (°)	Description
20...100%	Setting range Factory setting: 60%

**[Unld.Thr.0.Speed] L u L ★**

Underload threshold at zero frequency as a % of the rated motor torque.  
 This parameter can be accessed if **[Unld T. Del. Detect] u L E** is not set to 0.

Setting ( )	Description
0... <b>[Unld.Thr.Nom.Speed] L u n</b>	Setting range <b>Factory setting:</b> 0%

**[Unld. FreqThr. Det.] r n u d ★**

Minimum frequency underload detection threshold.  
 This parameter can be accessed if **[Unld T. Del. Detect] u L E** is not set to 0.

Setting ( )	Description
0.0...500.0 Hz	Setting range <b>Factory setting:</b> 0.0 Hz

**[Hysteresis Freq] S r b ★**

Maximum deviation between the frequency reference and the motor frequency, which defines a steady state operation.  
 This parameter can be accessed if **[Unld T. Del. Detect] u L E** or **[Ovld Time Detect.] E o L** is not set to 0.

Setting ( )	Description
0.3...500.0 Hz	Setting range <b>Factory setting:</b> 0.3 Hz

**[Underload Mangmt.] u d L ★**

Underload management.  
 Behavior on switching to underload detection.  
 This parameter can be accessed if **[Unld T. Del. Detect] u L E** is not set to 0.

Setting	Code / Value	Description
<b>[Ignore]</b>	n o	Detected error ignored
<b>[Freewheel stop]</b>	y E S	Freewheel stop <b>Factory setting</b>
<b>[Ramp stop]</b>	r n P	Stop on ramp
<b>[Fast stop]</b>	F S E	Fast stop

**[Underload T.B.Rest.] F E u ★**

Minimum time permitted between an underload being detected and any automatic restart.  
 To allow an automatic restart, the value of **[Fault Reset Time] E R r** must exceed this parameter by at least 1 minute.  
 This parameter can be accessed if **[Underload Mangmt.] u d L** is not set to **[Ignore] n o**.

Setting ( )	Description
0...6 min	Setting range <b>Factory setting:</b> 0 min

## [Process overload] $\sigma L d$ - Menu

### Access

[Complete settings] → [Error/Warning handling] → [Process overload]

### About This Menu

A process overload error is detected when the next event occurs and remains pending for a minimum time [Ovid Time Detect.]  $t_{\sigma L}$ , which is configurable:

- The drive is in [Current limitation]  $C L$ , mode during acceleration, deceleration, or,
- The motor is in steady state and the [Motor Current]  $L C r$  is above the set overload threshold [Ovid Detection Thr.]  $L_{\sigma L}$ .

The motor is in steady state when the offset difference between [Pre-Ramp Ref Freq]  $F r H$  and [Motor Frequency]  $r F r$  is less than the configurable threshold [Hysteresis Freq]  $S r b$ .

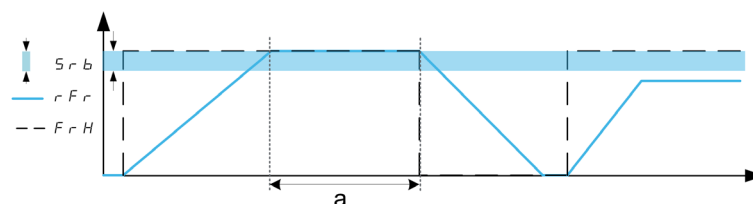

**NOTE:** Process overload monitoring is always active in [Current limitation]  $C L$ , state.

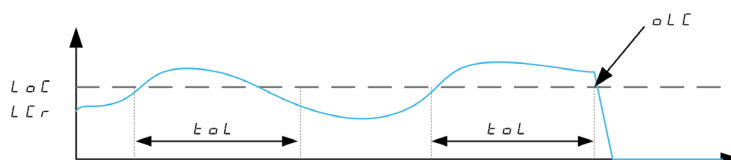

### [Ovid Time Detect.] $t_{\sigma L}$

Overload reaction time.

A value of 0 deactivates the function and makes the other parameters inaccessible.

Setting	Description
0...100 s	Setting range Factory setting: 0 s

### [Ovid Detection Thr.] $L_{\sigma L}$ ★

Overload threshold.

Overload detection threshold, as a % of the rated motor current [Nom Motor Current]  $n C r$ . This value must be less than the limit current in order for the function to work.

This parameter can be accessed if [Ovid Time Detect.]  $t_{\sigma L}$  is not set to 0.

Setting (◀)	Description
70...150%	Setting range Factory setting: 110%

**[Hysteresis Freq] 5 r b ★**

Hysteresis for steady state.

Maximum deviation between the frequency reference and the motor frequency, which defines a steady state operation.

This parameter can be accessed if **[Ovld Time Detect.] t o L** or **[Unld T. Del. Detect.] u L t** is not set to 0.

Setting ( )	Description
0.3...500.0 Hz	Setting range <b>Factory setting:</b> 0.3 Hz

**[Ovld.Proces.Mngmt] o d L ★**

Behavior on switching to overload detection.

This parameter can be accessed if **[Ovld Time Detect.] t o L** is not set to 0.

Setting	Code / Value	Description
<b>[Ignore]</b>	n o	Detected error ignored
<b>[Freewheel stop]</b>	y E 5	Freewheel stop <b>Factory setting</b>
<b>[Ramp stop]</b>	r n P	Stop on ramp
<b>[Fast stop]</b>	F 5 t	Fast stop

**[Overload T.B.Rest.] F t o ★**

Minimum time permitted between an overload being detected and any automatic restart.

In order to allow an automatic restart, the value of **[Fault Reset Time] t R r** must exceed this parameter by at least 1 minute.

This parameter can be accessed if **[Ovld Time Detect.] t o L** or **[Ovld.Process.Mngmt] o d L** is not set to 0.

Setting ( )	Description
0...6 min	Setting range <b>Factory setting:</b> 0 min



## [Warn grp 1 definition] *R 1 C* - Menu

### Access

[Complete settings] → [Error/Warning handling] → [Warning groups config] → [Warn grp 1 definition]

### About This Menu

The following submenus group the warnings into 1 to 5 groups, each of which can be assigned to a relay or a digital output for remote signaling.

When one or a number of warnings selected in a group occur, this warning group is activated.

### List of Warnings

The list of warning codes is available in the chapter "Diagnostics and Troubleshooting" (*see page 304*).

## [Warn grp 2 definition] *R 2 C* - Menu

### Access

[Complete settings] → [Error/Warning handling] → [Warning groups config] → [Warn grp 2 definition]

### About This Menu

Identical to [Warn grp 1 definition] *R 1 C* (*see page 273*)

## [Warn grp 3 definition] *R 3 C* - Menu

### Access

[Complete settings] → [Error/Warning handling] → [Warning groups config] → [Warn grp 3 definition]

### About This Menu

Identical to [Warn grp 1 definition] *R 1 C* (*see page 273*)

## [Warn grp 4 definition] *R 4 C* - Menu

### Access

[Complete settings] → [Error/Warning handling] → [Warning groups config] → [Warn grp 4 definition]

### About This Menu

Identical to [Warn grp 1 definition] *R 1 C* (*see page 273*)

## [Warn grp 5 definition] *R 5 C* - Menu

### Access

[Complete settings] → [Error/Warning handling] → [Warning groups config] → [Warn grp 5 definition]

### About This Menu

Identical to [Warn grp 1 definition] *R 1 C* (*see page 273*)

## Section 6.22 [Maintenance]

---

### What Is in This Section?

This section contains the following topics:

Topic	Page
[Diagnostics] <i>d R U</i> - Menu	275
[Fan management] <i>F A N A</i> - Menu	276
[Maintenance] <i>C S N A</i> - Menu	277

## [Diagnostics] *d F u* - Menu

### Access

[Complete settings] → [Maintenance] → [Diagnostics]

### About This Menu

This menu allows you to make simple test sequences for diagnostics.

### [FAN Diagnostics] *F n t*

Diagnostics of internal fan(s).

This starts a test sequence.

**NOTE:** This diagnostic is not accessible on ATV610U07N4 frame size 0.

**NOTE:** Fan diagnostics of internal fan(s) will be not-successful if the DC bus is not fully charged. This will be the case on separate control (e.g. the control block is only supplied on 24V).

### [LED Diagnostics] *H L t*

Diagnostics of product LED(s).

This starts a test sequence.

### [IGBT Diag w motor] *i W t*

Diagnostics of product IGBT(s).

This will start a test sequence with the connected motor (open circuit/short-circuit).

### [IGBT Diag w/o motor] *i W o t*

Diagnostics of product IGBT(s).

This starts a test sequence without the motor (short-circuit).

**[Fan management] F F Π Π - Menu**

**Access**

[Complete settings] → [Maintenance] → [Fan management]

**About This Menu**

Fan speed and [Fan Operation Time] F P b t are monitored values.

An abnormal low speed or the fan trigger a warning [Fan Feedback Warning] F F d R. As soon as [Fan Operation Time] F P b t reach the predefined value of 45,000 hours, a warning [Fan Counter Warning] F C t R is triggered.

[Fan Operation Time] F P b t counter can be set to 0 by using the [Counter Reset] r P r parameter.

**[Fan Mode] F F Π**

Fan activation mode.

**NOTE:** For ATV610U07N4 frame size 0, this parameter is forced to [Never] S t P.

Setting ( )	Code / Value	Description
[Standard]	S t d	The operation of the fan is enabled when the motor is running. According to the drive rating, this could be the only available setting <b>Factory setting</b>
[Always]	r u n	The fan is always activated
[Economy]	E c o	The fan is activated only if necessary, according to the internal thermal state of the drive

<i>NOTICE</i>
<p><b>OVERHEATING</b></p> <p>Verify that the ambient temperature does not exceed 40 °C (104° F) if the fan is disabled.</p> <p><b>Failure to follow these instructions can result in equipment damage.</b></p>

If [Fan Mode] F F Π is set to [Never] S t P, the fan of the drive is disabled.

**[Maintenance] C S P A - Menu****Access**

[Complete settings] → [Maintenance]

**[Time Counter Reset] r P r**

Time counter reset.

**NOTE:** The list of possible values depends on the product size.

Setting ( )	Code / Value	Description
[No]	n o	No <b>Factory setting</b>
[Run Time Reset]	r t H	Run time reset
[Power ON Time Reset]	P t H	Power ON time reset
[Reset Fan Counter]	F t H	Reset fan counter
[Clear NSM]	n S P	Clear number of motor starts

**[Overmodul. Activation] o v P A**This parameter can be accessed if **[Access Level] L A C** is set to **[Expert] E P r**.

The purpose of the Overmodulation is to compensate the loss of output voltage due to the load.

Setting	Code / Value	Description
[Default]	d E F F u L t	Overmodulation is not configured <b>Factory setting</b>
[Full]	F u L L	Over modulation is active



---

# Chapter 7

## [Communication] $\mathcal{L} \square \Pi$ -

---

### Introduction



[Communication]  $\mathcal{L} \square \Pi$  - menu presents the fieldbus submenus.

### What Is in This Chapter?

This chapter contains the following topics:

Topic	Page
[Modbus Fieldbus] $\Pi d I$ - Menu	280
[Com. scanner input] , $\mathcal{L} 5$ - Menu	281
[Com. scanner output] $\square \mathcal{L} 5$ - Menu	282
[Profibus] $P b \mathcal{L}$ - Menu	283

**[Modbus Fieldbus] *Π d l* - Menu****Access**

[Communication] → [Modbus Fieldbus]

**About This Menu**

This menu is related to the Modbus serial communication port on the bottom of the control block.  
Refer to the Modbus serial manual.

**[Modbus Address] *Α d d***

Drive Modbus address.

Setting	Description
[OFF] <i>α F F</i> ...247	Setting range <b>Factory setting:</b> [OFF] <i>α F F</i>

**[Bd.RateModbus] *ε b r***

Baud rate Modbus.

Setting	Code / Value	Description
[4800 bps]	<i>4 K B</i>	4,800 Bauds
[9600 bps]	<i>9 K B</i>	9,600 Bauds
[19200 bps]	<i>19 K 2</i>	19,200 Bauds <b>Factory setting</b>
[38.4 Kbps]	<i>38 K 4</i>	38,400 Bauds

**[Modbus Format] *ε F α***

Modbus communication format.

Setting	Code / Value	Description
[8-O-1]	<i>B α 1</i>	8 bits odd parity 1 stop bit
[8-E-1]	<i>B E 1</i>	8 bits even parity 1 stop bit <b>Factory setting</b>
[8-N-1]	<i>B n 1</i>	8 bits no parity 1 stop bit
[8-N-2]	<i>B n 2</i>	8 bits no parity 2 stop bits

**[Modbus Timeout] *ε ε α***

Modbus timeout.

Setting	Description
0.1 ...30.0 s	Setting range <b>Factory setting:</b> 10.s



## [Com. scanner input] , C 5 - Menu

### Access

[Communication] → [Com. scanner input]

### [Scan. IN1 address] *n P A 1*

Address of the first input word.

Setting	Description
0...65535	Setting range Factory setting: 3201 ( <i>E L A</i> )

### [Scan. IN2 address] *n P A 2*

Address of the second input word.

Setting	Description
0...65535	Setting range Factory setting: 8604 ( <i>r F r d</i> )

### [Scan. IN3 address] *n P A 3*

Address of the third input word.

Setting	Description
0...65535	Setting range Factory setting: 0

### [Scan. IN4 address] *n P A 4*

Address of the fourth input word.

Identical to [Scan. IN3 address] *n P A 3*.

### [Scan. IN5 address] *n P A 5*

Address of the fifth input word.

Identical to [Scan. IN3 address] *n P A 3*.

### [Scan. IN6 address] *n P A 6*

Address of the sixth input word.

Identical to [Scan. IN3 address] *n P A 3*.

### [Scan. IN7 address] *n P A 7*

Address of the seventh input word.

Identical to [Scan. IN3 address] *n P A 3*.

### [Scan. IN8 address] *n P A 8*

Address of the eighth input word.

Identical to [Scan. IN3 address] *n P A 3*.

**[Com. scanner output] ▢ L 5 - Menu****Access**

[Communication] → [Com. scanner output]

**[Scan.Out1 address] ▢ L R 1**

Address of the first output word.

Setting	Description
0...65535	Setting range <b>Factory setting:</b> 8501(L P d)

**[Scan.Out2 address] ▢ L R 2**

Address of the second output word.

Setting	Description
0...65535	Setting range <b>Factory setting:</b> 8602(L F r d)

**[Scan.Out3 address] ▢ L R 3**

Address of the third output word.

Setting	Description
0...65535	Setting range <b>Factory setting:</b> 0

**[Scan.Out4 address] ▢ L R 4**

Address of the fourth output word.

Identical to [Scan.Out3 address] ▢ L R 3.

**[Scan.Out5 address] ▢ L R 5**

Address of the fifth output word.

Identical to [Scan.Out3 address] ▢ L R 3.

**[Scan.Out6 address] ▢ L R 6**

Address of the sixth output word.

Identical to [Scan.Out3 address] ▢ L R 3.

**[Scan.Out7 address] ▢ L R 7**

Address of the seventh output word.

Identical to [Scan.Out3 address] ▢ L R 3.

**[Scan.Out8 address] ▢ L R 8**

Address of the eighth output word.

Identical to [Scan.Out3 address] ▢ L R 3.

## [Profibus] P b C - Menu

### Access

[Communication] → [Profibus]

### About This Menu

Refer to the Profibus DP fieldbus module manual.



---

# Chapter 8

## [File management] *F Π E* -

---

### Introduction



[File management] *F Π E* - menu presents the management of drive configuration files.

### What Is in This Chapter?

This chapter contains the following topics:

Topic	Page
[Transfer config file] <i>E C F</i> - Menu	286
[Factory settings] <i>F C S</i> - Menu	286
[Parameter group list] <i>F r Y</i> - Menu	287
[Factory settings] <i>F C S</i> - Menu	288
[Firmware update diag] <i>F W u d</i> - Menu	289

**[Transfer config file] *ⓧ* *ⓧ* *F* - Menu****Access**

[File management] → [Transfer config file]

**[Copy to the drive] *ⓧ* *ⓧ* *F***

This allows to select a previously saved configuration from the Plain Text Display Terminal memory and transfer it to the .

The needs to be restarted after a configuration file transfer.

**[Copy from the drive] *ⓧ* *ⓧ* *F***

This allows to save the actual configuration into the Plain Text Display Terminal memory.

**NOTE:** The Graphic Display Terminal can store up to 16 configuration files.

**[Factory settings] *F* *ⓧ* *ⓧ* - Menu****Access**

[File management] → [Factory settings]

**About This Menu**

This parameter allows to select the configuration to restore in case of factory setting operation.

**[Config. Source] *F* *ⓧ* *ⓧ* , ★**

Setting	Code / Value	Description
[Macro-Conf]	<i>ⓧ</i> <i>ⓧ</i> <i>ⓧ</i>	Factory setting parameter set <b>Factory setting</b>
[Config 1]	<i>ⓧ</i> <i>F</i> <i>ⓧ</i> <i>1</i>	Customer parameter set 1
[Config 2]	<i>ⓧ</i> <i>F</i> <i>ⓧ</i> <i>2</i>	Customer parameter set 2
[Config 3]	<i>ⓧ</i> <i>F</i> <i>ⓧ</i> <i>3</i>	Customer parameter set 3

## [Parameter group list] *F r Y* - Menu

### Access

[File management] → [Factory settings] → [Parameter group list]

### About This Menu

Selection of menus to be loaded.

**NOTE:** In factory configuration and after a return to "factory settings", [Parameter group list] *F r Y* will be empty.

### [All] *ALL*

All parameters in all menus.

### [Drive Configuration] *d r Π*

Load [Complete settings] *C S E* - menu.

### [Motor Param] *Π α ε*

Load [Motor parameters] *Π P R* - menu.

### [Comm. Menu] *C α Π* ★

Load [Communication] *C α Π* - menu.

This parameter can be accessed if [Config. Source] *F C S* is set to [Macro-Conf] *ι η ι*.

### [Display Config.] *d , 5* ★

Load [Display screen type] *Π S C* - menu.

This parameter can be accessed if [Config. Source] *F C S* is set to [Macro-Conf] *ι η ι*.

**[Factory settings] F C 5 - Menu****Access**

[File management] → [Factory settings]

**[Go to Factory settings] G F 5****⚠ WARNING****UNANTICIPATED EQUIPMENT OPERATION**

Verify that restoring the factory settings is compatible with the type of wiring used.

**Failure to follow these instructions can result in death, serious injury, or equipment damage.**

It is only possible to revert to the factory settings if at least one group of parameters has previously been selected.

**[Save Configuration] S C 5 , ★**

Save configuration.

The active configuration to be saved does not appear for selection. For example, if it is **[Config 0] S E r 0**, only **[ Config 1] S E r 1**, **[Config 2] S E r 2** and **[ Config 3] S E r 3** appear. The parameter changes back to **[No] n o** as soon as the operation is complete.

Setting	Code / Value	Description
[No]	n o	No <b>Factory setting</b>
[Config 0]	S E r 0	Store customer parameter set 0
[Config 1]	S E r 1	Store customer parameter set 1
[Config 2]	S E r 2	Store customer parameter set 2
[Config 3]	S E r 3	Store customer parameter set 3



**[Firmware update diag] FWUD - Menu****Access**

[File management] → [Firmware update] → [Firmware update diag]

**About This Menu**

This menu can be accessed in expert mode.

**[Firmware Update Status] FWSE**

Setting	Code / Value	Description
[Inactive]	<i>C H E C K</i>	Firmware update inactive
[PwrUpd in progress]	<i>P o W E r</i>	Power update in progress
[PwrUpd Pending]	<i>P E n d</i>	Power update pending
[Ready]	<i>r d y</i>	Firmware update ready
[Inactive]	<i>n o</i>	Firmware update inactive
[Succeeded]	<i>S u C C e d</i>	Firmware update succeeded
[Update Error]	<i>F A I L E d</i>	Update error
[In Progress]	<i>P r o G</i>	Firmware update in progress
[Requested]	<i>r e q u e s t e d</i>	Firmware update requested
[Transfer In Progress]	<i>t r L d</i>	Transfer in progress
[Transfer Done]	<i>t r o K</i>	Transfer done
[Package cleared]	<i>C L E A r</i>	Package cleared
[Warning]	<i>S u C W r</i>	Firmware update succeeded with warnings
[Drive State Error]	<i>F L S t A</i>	state error
[Package Error]	<i>F L P K G</i>	Package error
[Saving conf]	<i>S A V E</i>	Firmware update is saving the current configuration
[Post Script]	<i>P o S t</i>	Firmware update is doing the post FWUPD

**[Firmware Update Error] FWER**

Setting	Code / Value	Description
[No Error]	<i>n o</i>	No error
[Lock Error]	<i>L o C K</i>	Lock error
[Package Error]	<i>P a c k e t</i>	Package error
[Package compatibility error]	<i>C o m p</i>	Package compatibility error
[Ask error]	<i>A S K</i>	Ask error
[Reset Drive Error]	<i>r e S E t</i>	Reset error
[Conf Saving Warning]	<i>S A V E</i>	Configuration saving warning
[Conf Loading Warning]	<i>L o A d</i>	Configuration loading warning
[Post Script Warning]	<i>S C P</i>	Post script warning
[Package Description Error]	<i>d e s</i>	Package description error
[Package not found]	<i>P K G</i>	Package not found
[Power Supply error]	<i>S P W r</i>	Power supply error
[Boot M3 error]	<i>b t M 3</i>	Boot M3 error

Setting	Code / Value	Description
[Boot C28 error]	<i>b t C 2 B</i>	Boot C28 error
[M3 Error]	<i>M 3</i>	M3 error
[C28 error]	<i>C 2 B</i>	C28 error
[CPLD error]	<i>C P L d</i>	CPLD error
[Boot Power Error]	<i>P W r</i>	Boot power error
[Emb. Eth Boot Error]	<i>E n b t</i>	Embedded ethernet boot error
[Emb. Eth Error]	<i>E n , L</i>	Embedded ethernet error
[Emb. Eth Web Error]	<i>E n W b</i>	Embedded ethernet WebServer error
[Module Eth Boot Error]	<i>o P t b t</i>	Module ethernet boot error
[Module Eth Error]	<i>o P t , L</i>	Module ethernet error
[Module Eth Web Error]	<i>o P t W b</i>	Module ethernet WebServer error
[Password enabled]	<i>P 5 W d</i>	Password enabled
[Flash Error]	<i>M E n</i>	Flash error
[Package error]	<i>, F o</i>	Package information error

---

# Chapter 9

## [My preferences] ПУР -

---

### Introduction



[My preferences] ПУР - menu presents the possible settings for the user-defined HMI and parameter access.

### What Is in This Chapter?

This chapter contains the following sections:

Section	Topic	Page
9.1	[Language]	292
9.2	[Password]	293
9.3	[Customization]	295
9.4	[Access level]	296
9.5	[LCD settings]	297

## Section 9.1

### [Language]

---

#### [Language] L n G - Menu

##### Access

[My preferences] → [Language]

##### About This Menu

This menu allows to select the Plain Text Display Terminal language.

The following languages can be selected:

- English,
- Chinese,
- German,
- Spanish,
- French,
- Italian,
- Russian,
- Turkish.

## Section 9.2

### [Password]

#### [Password] *Code* - Menu

##### Access

[My preferences] → [Password]

##### About This Menu

Enables the configuration to be protected with an access code or a password to be entered in order to access a protected configuration:

- The is unlocked when the password is set to **[No password defined]** *no* or when the correct password has been entered. All menus can be accessed.
- Before protecting the configuration with a password, you must:
  - Define the **[Upload rights]** *ULr* and **[Download rights]** *dLr*.
  - Make a careful note of the password and keep it in a place where you are able to find it.

#### [Password status] *PSSt*

Password status.

Read only parameter.

Setting	Code / Value	Description
<b>[No password defined]</b>	<i>no</i>	No password defined <b>Factory setting</b>
<b>[Password is unlocked]</b>	<i>UL</i>	Password is unlocked
<b>[Password is locked]</b>	<i>LdC</i>	Password is locked

#### [Password] *Pwd*

6-characters password. To lock the drive, define and enter your password. **[Password status]** *PSSt* value switches to **[Password is locked]** *LdC*.

To unlock the drive, the password must be entered. Once the correct code has been entered, the is unlocked and **[Password status]** *PSSt* value switches to **[Password is unlocked]** *UL*. Access will be locked again the next time the is switched on.

To modify the password, unlock the drive then enter the new password. Entering a new password locks the drive.

To remove the password, the drive must be unlocked and the password 000000 must be entered. **[Password status]** *PSSt* value switches to **[No password defined]** *no*. At next switch-on, the remains unlocked.

#### [Upload rights] *ULr*

Upload rights.

Setting 	Code / Value	Description
<b>[Permitted]</b>	<i>ULrD</i>	Commissioning tools or the Plain Text Display Terminal can save the whole configuration (password, monitoring, configuration) <b>Factory setting</b>
<b>[Not allowed]</b>	<i>ULrI</i>	Commissioning tools or the Plain Text Display Terminal cannot save the configuration if the is not protected by a password or if the in-correct password has been entered

**[Download rights] d L r**

Download rights.

Setting( )	Code / Value	Description
[Locked drv]	d L r 0	Lock : the configuration can be downloaded to the only if the is protected by a password, which is the same as the password of the configuration to be downloaded
[Unlock. drv]	d L r 1	Unlock : the configuration can be downloaded to the or a configuration can be modified if the is unlocked or is not protected by a password <b>Factory setting</b>
[Not allowed]	d L r 2	The configuration cannot be downloaded
[Lock/unlock]	d L r 3	Combination of [Locked drv] d L r 0 and [Unlock. drv] d L r 1

## Section 9.3

### [Customization]

#### [Display screen type] *Π 5 C* - Menu

##### Access

[My preferences] → [Customization] → [Display screen type]

#### [Display value type] *Π d t*

Type of screen display.

Setting	Code / Value	Description
[Digital]	<i>d E C</i>	Digital value <b>Factory setting</b>
[Bar graph]	<i>b R r</i>	Bar graph

#### [Parameter Selection] *Π P C*

Customized selection.

This view allows to select the parameters to display on the default screen.

## Section 9.4 [Access level]

---

### [Access level] L R C - Menu

#### Access

[My preferences] → [Access level]

#### [Access Level] L R C

Level of access control.

Setting ( )	Code / Value	Description
[Basic]	<i>b R S</i>	Access to all menus. <b>Factory setting</b>
[Expert]	<i>E P r</i>	Access to all menus and to additional parameters.



## Section 9.5

### [LCD settings]

#### [LCD settings] **C n L** - Menu

##### Access

[My preferences] → [LCD settings]

##### About This Menu

This menu allows to set the Plain Text Display Terminal related parameters.

#### [Screen Contrast] **C S L**

Screen contrast setting.

Setting	Description
0...100%	Setting range <b>Factory setting:</b> 50%

#### [Standby] **S b Y**

Stand-by delay.

**NOTE:** Disabling the automatic standby function of the display terminal backlight will reduce the backlight service time.

Setting	Description
n 0...10 min	Automatic backlight OFF time <b>Factory setting:</b> 10 min

#### [Display Terminal locked] **K L C K**

Plain Text Display Terminal key locked. Press **ESC** and **Home** keys to Lock manually & unlock the Plain Text Display Terminal keys. The **Stop** key remains active when the Plain Text Display Terminal is locked.

Setting ( )	Description
n 0...10 min	Setting range <b>Factory setting:</b> 5 min



---

## Part III

### Maintenance and diagnostics

---

#### What Is in This Part?

This part contains the following chapters:

Chapter	Chapter Name	Page
10	Maintenance	301
11	Diagnostics and Troubleshooting	303



# Chapter 10

## Maintenance

### Maintenance

#### Limitation of Warranty

The warranty does not apply if the product has been opened, except by Schneider Electric services.

#### Servicing

 <b>DANGER</b>
<b>HAZARD OF ELECTRIC SHOCK, EXPLOSION OR ARC FLASH</b>
Read and understand the instructions in <b>Safety Information</b> chapter before performing any procedure in this chapter.
<b>Failure to follow these instructions will result in death or serious injury.</b>

The temperature of the products described in this manual may exceed 80 °C (176 °F) during operation.

 <b>WARNING</b>
<b>HOT SURFACES</b>
<ul style="list-style-type: none"> <li>• Ensure that any contact with hot surfaces is avoided.</li> <li>• Do not allow flammable or heat-sensitive parts in the immediate vicinity of hot surfaces.</li> <li>• Verify that the product has sufficiently cooled down before handling it.</li> <li>• Verify that the heat dissipation is sufficient by performing a test run under maximum load conditions.</li> </ul>
<b>Failure to follow these instructions can result in death, serious injury, or equipment damage.</b>

 <b>WARNING</b>
<b>INSUFFICIENT MAINTENANCE</b>
Verify that the maintenance activities described below are performed at the specified intervals.
<b>Failure to follow these instructions can result in death, serious injury, or equipment damage.</b>

Adherence to the environmental conditions must be ensured during operation of the drive. In addition, during maintenance, verify and, if appropriate, correct all factors that may have an impact on the environmental conditions.

	Part concerned	Activity	Interval (1)
Overall condition	All parts such as housing, HMI, control block, connections, etc.	Perform a visual inspection	At least every year
Corrosion	Terminals, connectors, screws, EMC plate	Inspect and clean if required	
Dust	Terminals, fans, enclosures air inlets and air outlets, air filters of cabinet	Inspect and clean if required	
	Floor standing drives filter mats	Inspect	At least every year
		Change	At least every 4 years
<b>(1)</b> Maximum maintenance intervals from the date of commissioning. Reduce the intervals between maintenance to adapt maintenance to the environmental conditions, the operating conditions of the drive, and to any other factor that may influence the operation and/ or maintenance requirements of the drive.			

	Part concerned	Activity	Interval (1)
Cooling	Wall mounting drives fan	Verify the fan operation	At least every year
		Replace the fan, see catalog and the instructions sheets on <a href="http://www.schneider-electric.com">www.schneider-electric.com</a> .	After 3 to 5 years, depending on the operating conditions
	Fastening	All screws for electrical and mechanical connections	Verify tightening torques
<b>(1)</b> Maximum maintenance intervals from the date of commissioning. Reduce the intervals between maintenance to adapt maintenance to the environmental conditions, the operating conditions of the drive, and to any other factor that may influence the operation and/ or maintenance requirements of the drive.			

**Spares and Repairs**

Serviceable product. Please contact your Customer Care Center on:

[www.schneider-electric.com/CCC](http://www.schneider-electric.com/CCC).

**Long Time Storage**

If the drive was not connected to mains for an extended period of time, the capacitors must be restored to their full performance before the motor is started.

<i>NOTICE</i>
<p><b>REDUCED CAPACITOR PERFORMANCE</b></p> <ul style="list-style-type: none"> <li>● Apply mains voltage to the drive for one hour before starting the motor if the drive has not been connected to mains for the following periods of time:               <ul style="list-style-type: none"> <li>○ 12 months at a maximum storage temperature of +50°C (+122°F)</li> <li>○ 24 months at a maximum storage temperature of +45°C (+113°F)</li> <li>○ 36 months at a maximum storage temperature of +40°C (+104°F)</li> </ul> </li> <li>● Verify that no Run command can be applied before the period of one hour has elapsed.</li> <li>● Verify the date of manufacture if the drive is commissioned for the first time and run the specified procedure if the date of manufacture is more than 12 months in the past.</li> </ul> <p><b>Failure to follow these instructions can result in equipment damage.</b></p>

If the specified procedure cannot be performed without a Run command because of internal mains contactor control, perform this procedure with the power stage enabled, but the motor being at standstill so that there is no appreciable mains current in the capacitors.

**Fan Replacement**

It is possible to order a new fan for the drive maintenance, see the catalog numbers on [www.schneider-electric.com](http://www.schneider-electric.com).

**Customer Care Center**

For additional support, you can contact our Customer Care Center on:

[www.schneider-electric.com/CCC](http://www.schneider-electric.com/CCC).

---

# Chapter 11

## Diagnostics and Troubleshooting

---

### Overview

This chapter describes the various types of diagnostics and provides troubleshooting assistance.

 <b>DANGER</b>		
<b>HAZARD OF ELECTRIC SHOCK, EXPLOSION OR ARC FLASH</b>		
Read and understand the instructions in <b>Safety Information</b> chapter before performing any procedure in this chapter.		
<b>Failure to follow these instructions will result in death or serious injury.</b>		

### What Is in This Chapter?

This chapter contains the following sections:

Section	Topic	Page
11.1	Warning Codes	304
11.2	Error Codes	305
11.3	FAQ	346

## Section 11.1

### Warning Codes

#### Warning Codes

##### List of Available Warnings Messages

Setting	Code	Description
[No Warning stored]	n o R	No warning stored
[Fallback Frequency]	F r F	Reaction on event: Fallback frequency
[Speed Maintained]	r L S	Reaction on event: Speed maintained
[Type of stop]	S t t	Reaction on event: Stop following [Type of stop] S t t without triggering an error
[Ref Frequency Warning]	S r R	Frequency reference reached
[PID error Warning]	P E E	PID error warning
[PID Feedback Warn]	P F R	PID feedback warning
[AI3 Th Warning]	t P 3 R	AI3 Thermal warning
[AI4 Th Warning]	t P 4 R	AI4 Thermal warning
[AI5 Th Warning]	t P 5 R	AI5 Thermal warning
[AI1 4-20 Loss Warning]	R P 1	AI1 4-20 mA loss warning
[AI3 4-20 Loss Warning]	R P 3	AI3 4-20 mA loss warning
[AI4 4-20 Loss Warning]	R P 4	AI4 4-20 mA loss warning
[AI5 4-20 Loss Warning]	R P 5	AI5 4-20 mA loss warning
[Fan Counter Warning]	F C t R	Fan counter speed warning
[Fan Feedback Warning]	F F d R	Fan feedback warning
[BR Thermal Warning]	b o R	Braking resistor thermal warning
[Ext. Error Warning]	E F R	External error warning
[Undervoltage Warning]	u S R	Undervoltage warning
[Preventive UnderV Active] <i>(see page 260)</i>	u P R	Controlled stop threshold is reached
[Mot Freq High Thd]	F t R	Motor frequency high threshold 1 reached
[Mot Freq Low Thd]	F t R L	Motor frequency low threshold 1 reached
[Mot Freq Low Thd 2]	F 2 R L	Motor frequency low threshold 2 reached
[High Speed Reached]	F L R	High speed reached warning
[Ref Freq High Thd reached]	r t R H	Reference frequency high threshold reached
[Ref Freq Low Thd reached]	r t R L	Reference frequency low threshold reached
[2nd Freq Thd Reached]	F 2 R	Motor frequency high threshold 2 reached
[Current Thd Reached]	C t R	Motor current high threshold reached
[Low Current Reached]	C t R L	Motor current low threshold reached
[Process Undld Warning]	u L R	Underload warning
[Process Overload Warning]	o L R	Overload warning
[Drv Therm Thd reached]	t R d	Drive thermal threshold reached
[Motor Therm Thd reached]	t S R	Motor thermal threshold reached
[Pos. Following Warn]	P F E S	Position following warning
[Temp Sens AI2 Warn]	t S 2 R	Temperature sensor AI2 warning (open circuit)
[Temp Sens AI3 Warn]	t S 3 R	Temperature sensor AI3 warning (open circuit)
[Temp Sens AI4 Warn]	t S 4 R	Temperature sensor AI4 warning (open circuit)
[Temp Sens AI5 Warn]	t S 5 R	Temperature sensor AI5 warning (open circuit)



## Section 11.2

### Error Codes

#### What Is in This Section?

This section contains the following topics:

Topic	Page
Overview	307
[Circuit Breaker Error] <i>C b F</i>	308
[Incorrect Configuration] <i>C F F</i>	308
[Invalid Configuration] <i>C F ,</i>	309
[Conf Transfer Error] <i>C F , 2</i>	309
[Pre-settings Transfer Error] <i>C F , 3</i>	310
[Fieldbus Com Interrupt] <i>C n F</i>	310
[Precharge Capacitor] <i>C r F 1</i>	311
[Channel Switch Error] <i>C S F</i>	311
[EEPROM Control] <i>E E F 1</i>	312
[EEPROM Power] <i>E E F 2</i>	312
[External Error] <i>E P F 1</i>	313
[Fieldbus Error] <i>E P F 2</i>	313
[Firmware Update Error] <i>F W E r</i>	314
[Internal Link Error] <i>, L F</i>	314
[Internal Error 0] <i>, n F 0</i>	315
[Internal Error 1] <i>, n F 1</i>	315
[Internal Error 2] <i>, n F 2</i>	316
[Internal Error 3] <i>, n F 3</i>	316
[Internal Error 4] <i>, n F 4</i>	317
[Internal Error 6] <i>, n F 6</i>	317
[Internal Error 7] <i>, n F 7</i>	318
[Internal Error 8] <i>, n F B</i>	318
[Internal Error 9] <i>, n F 9</i>	319
[Internal Error 10] <i>, n F A</i>	319
[Internal Error 11] <i>, n F b</i>	320
[Internal Error 12] <i>, n F C</i>	320
[Internal Error 13] <i>, n F d</i>	321
[Internal Error 14] <i>, n F E</i>	321
[Internal Error 15] <i>, n F F</i>	322
[Internal Error 16] <i>, n F G</i>	322
[Internal Error 17] <i>, n F H</i>	323
[Internal Error 20] <i>, n F K</i>	323
[Internal Error 21] <i>, n F L</i>	324
[Internal Error 25] <i>, n F P</i>	324
[Internal Error 27] <i>, n F r</i>	325
[Internal Error 30] <i>, n F u</i>	325
[Input Contactor] <i>L C F</i>	326
[AI1 4-20mA loss] <i>L F F 1</i>	326
[AI2 4-20mA loss] <i>L F F 2</i>	327

Topic	Page
[AI3 4-20mA loss] <i>L F F 3</i>	327
[AI4 4-20mA loss] <i>L F F 4</i>	328
[AI5 4-20mA loss] <i>L F F 5</i>	328
[Lead Pump Error] <i>Π P L F</i>	329
[DC Bus Overvoltage] <i>α b F</i>	329
[Overcurrent] <i>α C F</i>	330
[Drive Overheating] <i>α H F</i>	330
[Process Overload] <i>α L C</i>	331
[Motor Overload] <i>α L F</i>	331
[Single Output Phase Loss] <i>α P F 1</i>	332
[Output Phase Loss] <i>α P F 2</i>	332
[Supply Mains Overvoltage] <i>α S F</i>	333
[PID Feedback Error] <i>P F Π F</i>	333
[Program Loading Error] <i>P G L F</i>	334
[Program Running Error] <i>P G r F</i>	334
[Input phase loss] <i>P H F</i>	335
[Motor short circuit] <i>S C F 1</i>	335
[Ground Short Circuit] <i>S C F 3</i>	336
[IGBT Short Circuit] <i>S C F 4</i>	336
[Motor Short Circuit] <i>S C F 5</i>	337
[Modbus Com Interruption] <i>S L F 1</i>	337
[HMI Com Interruption] <i>S L F 3</i>	338
[Motor Overspeed] <i>S α F</i>	338
[Motor Stall Error] <i>S t F</i>	339
[AI2 Thermal Sensor Error] <i>t 2 C F</i>	339
[AI3 Thermal Sensor Error] <i>t 3 C F</i>	340
[AI4 Thermal Sensor Error] <i>t 4 C F</i>	340
[AI5 Thermal Sensor Error] <i>t 5 C F</i>	341
[AI2 Th Level Error] <i>t H 2 F</i>	341
[AI3 Th Level Error] <i>t H 3 F</i>	342
[AI4 Th Level Error] <i>t H 4 F</i>	342
[AI5 Th Level Error] <i>t H 5 F</i>	343
[IGBT Overheating] <i>t J F</i>	343
[Autotuning Error] <i>t n F</i>	344
[Process Underload] <i>υ L F</i>	344
[Supply Mains UnderV] <i>υ S F</i>	345

## Overview

### Clearing the Detected Error

This table presents the steps to follow if intervention on the drive system is required:

Step	Action
1	Disconnect all power, including external control power that may be present.
2	Lock all power disconnects in the open position.
3	Wait 15 minutes to allow the DC bus capacitors to discharge (the drive LEDs are not indicators of the absence of DC bus voltage).
4	Measure the voltage of the DC bus between the PA/+ and PC/- terminals to ensure that the voltage is less than 42 Vdc.
5	If the DC bus capacitors do not discharge completely, contact your local Schneider Electric representative. Do not repair or operate the drive.
6	Find and correct the cause of the detected error.
7	Restore power to the drive to confirm that the detected error has been rectified.

After the cause has been removed, the detected error can be cleared by:

- Switching off the drive.
- Using the **[Product Restart]**  $r P$  parameter.
- Using the digital input or the control bit assigned to **[Prod Restart Assign]**  $r P R$ .
- Using the **[Auto Fault Reset]**  $R E r$  - function.
- A digital input or control bit set to the **[Fault reset]**  $r S E$  - function.
- Pressing the **STOP/RESET** key on the Plain Text Display Terminal depending on the setting of **[Stop Key Enable]**  $P S E$ .

### How To Clear the Error Code?

The following table summarizes the possibilities to clear a detected error:

How to clear the error code after the cause has been removed	List of the cleared error
<ul style="list-style-type: none"> <li>• Switch off the drive.</li> <li>• Use the <b>[Product Restart]</b> <math>r P</math> parameter.</li> <li>• Use the digital input or the control bit assigned to <b>[Prod Restart Assign]</b> <math>r P R</math>.</li> </ul>	All detected error.
<ul style="list-style-type: none"> <li>• As soon as its cause has been removed.</li> </ul>	CFF, CFI, CFI2, CFI3, CSF, FWER, PGLF, PHF, USF
<ul style="list-style-type: none"> <li>• Use the digital input or the control bit assigned to <b>[Fault Reset Assign]</b> <math>r S F</math>.</li> <li>• Press the STOP/RESET key.</li> </ul>	SOF, TNF
<ul style="list-style-type: none"> <li>• Use the digital input or the control bit assigned to <b>[Fault Reset Assign]</b> <math>r S F</math>.</li> <li>• Press the STOP/RESET key.</li> <li>• Use the <b>[Auto Fault Reset]</b> <math>R E r</math> - function.</li> </ul>	CNF, EPF1, EPF2, INF9, INFB, INFD, LCF, LFF1, LFF2, LFF3, LFF4, LFF5, MPLF, OBF, OHF, OLC, OLF, OPF1, OPF2, OSF, PFMF, SCF4, SCF5, SLF1, SLF3, STF, T2CF, T3CF, T4CF, T5CF, TH2F, TH3F, TH4F, TH5F, TJF, ULF

## [Circuit Breaker Error] *L L F*



### Probable Cause

The DC bus voltage level is not correct compared to the circuit breaker logic control (start or stop pulse) after the configured timeout **[Mains V. time out] L L E**.



### Remedy

- Verify the circuit breaker logic control (pulse time for start and stop).
- Verify the mechanical state of the circuit breaker.



### Clearing the Error Code

This detected error requires a power reset.

## [Incorrect Configuration] *L F F*



### Probable Cause

- Option module changed or removed.
- Control block replaced by a control block configured on a drive with a different rating.
- The current configuration is inconsistent.



### Remedy

- Verify that there is no detected error on the option module.
- In the event of the control block being changed deliberately, see the remarks below.
- Return to factory settings or retrieve the backup configuration if it is valid.



### Clearing the Error Code

This detected error is cleared as soon as its cause has been removed.

**[Invalid Configuration] [ F ,****Probable Cause**

Invalid configuration. The configuration loaded in the drive via the commissioning tool or fieldbus is inconsistent.

**Remedy**

- Verify the loaded configuration.
- Load a valid configuration.

**Clearing the Error Code**

This detected error is cleared as soon as its cause has been removed.

**[Conf Transfer Error] [ F , 2****Probable Cause**

- The configuration transfer to the drive was not successful or interrupted.
- The configuration loaded is not compatible with the drive.

**Remedy**

- Verify the configuration loaded previously.
- Load a compatible configuration.
- Use PC software commissioning tool to transfer a compatible configuration
- Perform a factory setting

**Clearing the Error Code**

This detected error is cleared as soon as its cause has been removed.

### [Pre-settings Transfer Error] *C F 1 3*



#### Probable Cause

The configuration transfer to the drive was not successful or interrupted.



#### Remedy

Contact your local Schneider Electric representative.



#### Clearing the Error Code

This detected error is cleared as soon as its cause has been removed.

### [Fieldbus Com Interrupt] *C n F*



#### Probable Cause

Communication interruption on fieldbus module.

This error is triggered when the communication between the fieldbus module and the master (PLC) is interrupted.



#### Remedy

- Verify the environment (electromagnetic compatibility).
- Verify the wiring.
- Verify the timeout.
- Replace the option module.
- Contact your local Schneider Electric representative



#### Clearing the Error Code

This detected error can be cleared with the **[Auto Fault Reset] *A F r*** or manually with the **[Fault Reset Assign] *r 5 F*** parameter after the cause has been removed.

**[Precharge Capacitor] C r F I****Probable Cause**

- Charging circuit control detected error or charging resistor damaged.

**Remedy**

- Turn off the drive and then turn on again.
- Verify the internal connections.
- Contact your local Schneider Electric representative

**Clearing the Error Code**

This detected error requires a power reset.

**[Channel Switch Error] C 5 F****Probable Cause**

Switch to an invalid channel.

**Remedy**

Verify the function parameters.

**Clearing the Error Code**

This detected error is cleared as soon as its cause has been removed.

### [EEPROM Control] E E F 1



#### Probable Cause

An error of the internal memory of the control block has been detected.



#### Remedy

- Verify the environment (electromagnetic compatibility).
- Switch off the product.
- Return to factory settings.
- Contact your local Schneider Electric representative.



#### Clearing the Error Code

This detected error requires a power reset.

### [EEPROM Power] E E F 2



#### Probable Cause

An error of the internal memory of the power board has been detected.



#### Remedy

- Verify the environment (electromagnetic compatibility).
- Switch off the product.
- Return to factory settings.
- Contact your local Schneider Electric representative.



#### Clearing the Error Code

This detected error requires a power reset.



## [External Error] *E P F 1*



### Probable Cause

- Event triggered by an external device, depending on user.
- An external error has been triggered via Embedded Ethernet.



### Remedy

Remove the cause of the external error.



### Clearing the Error Code

This detected error can be cleared with the **[Auto Fault Reset] *A E r*** or manually with the **[Fault Reset Assign] *r S F*** parameter after the cause has been removed.

## [Fieldbus Error] *E P F 2*



### Probable Cause

An external error has been triggered via fieldbus.



### Remedy

Remove the cause of the external error.



### Clearing the Error Code

This detected error can be cleared with the **[Auto Fault Reset] *A E r*** or manually with the **[Fault Reset Assign] *r S F*** parameter after the cause has been removed.

### [Firmware Update Error] *F W E r*



#### Probable Cause

Firmware update function has detected an error.



#### Remedy

Contact your local Schneider Electric representative.



#### Clearing the Error Code

This detected error is cleared as soon as its cause has been removed.

### [Internal Link Error] *I L F*



#### Probable Cause

Communication interruption between option module and the drive.



#### Remedy

- Verify the environment (electromagnetic compatibility).
- Verify the connections.
- Replace the option module.
- Contact your local Schneider Electric representative.



#### Clearing the Error Code

This detected error requires a power reset.

**[Internal Error 0] INF 0****Probable Cause**

- Communication interruption between microprocessors of the control board.
- The power board rating is not valid.

**Remedy**

Contact your local Schneider Electric representative.

**Clearing the Error Code**

This detected error requires a power reset.

**[Internal Error 1] INF 1****Probable Cause**

The power board rating is not valid.

**Remedy**

Contact your local Schneider Electric representative.

**Clearing the Error Code**

This detected error requires a power reset.

### [Internal Error 2] INF2



#### Probable Cause

The power board is incompatible with the control block software.



#### Remedy

Contact your local Schneider Electric representative.



#### Clearing the Error Code

This detected error requires a power reset.

### [Internal Error 3] INF3



#### Probable Cause

Internal communication detected error.



#### Remedy

- Verify the wiring on drive control terminals (internal 10V supply for analog inputs overloaded).
- Contact your local Schneider Electric representative.



#### Clearing the Error Code

This detected error requires a power reset.

**[Internal Error 4] INF 4****Probable Cause**

Internal data inconsistent.

**Remedy**

Contact your local Schneider Electric representative.

**Clearing the Error Code**

This detected error requires a power reset.

**[Internal Error 6] INF 6****Probable Cause**

- The option module installed in the drive is not recognized.
- The removable control terminal modules (if existing) are not present or not recognized.
- The embedded Ethernet adapter is not recognized.

**Remedy**

- Verify the catalog number and compatibility of the option module.
- Plug the removable control terminal modules after the drive has been switched off.
- Contact your local Schneider Electric representative.

**Clearing the Error Code**

This detected error requires a power reset.

### [Internal Error 7] INF 7



#### Probable Cause

Communication interruption with CPLD component of Control board.



#### Remedy

Contact your local Schneider Electric representative.



#### Clearing the Error Code

This detected error requires a power reset.

### [Internal Error 8] INF 8



#### Probable Cause

The internal power switching supply is not correct.



#### Remedy

Contact your local Schneider Electric representative.



#### Clearing the Error Code

This detected error requires a power reset.

**[Internal Error 9] INF 9****Probable Cause**

An error on the current circuit measurement has been detected.

**Remedy**

Contact your local Schneider Electric representative.

**Clearing the Error Code**

This detected error can be cleared with the **[Auto Fault Reset] RE r** or manually with the **[Fault Reset Assign] r 5 F** parameter after the cause has been removed.

**[Internal Error 10] INF 10****Probable Cause**

The input stage is not operating correctly.

**Remedy**

Contact your local Schneider Electric representative.

**Clearing the Error Code**

This detected error requires a power reset.

### [Internal Error 11] *INFb*



#### Probable Cause

The internal drive thermal sensor is not operating correctly.



#### Remedy

Contact your local Schneider Electric representative.



#### Clearing the Error Code

This detected error can be cleared with the **[Auto Fault Reset] *AEr*** or manually with the **[Fault Reset Assign] *r5F*** parameter after the cause has been removed.

### [Internal Error 12] *INFc*



#### Probable Cause



#### Remedy

Contact your local Schneider Electric representative.



#### Clearing the Error Code

This detected error requires a power reset.



**[Internal Error 13] *INFd*****Probable Cause**

Differential current deviation.

**Remedy**

Contact your local Schneider Electric representative.

**Clearing the Error Code**

This detected error can be cleared with the **[Auto Fault Reset] *AFr*** or manually with the **[Fault Reset Assign] *rSF*** parameter after the cause has been removed.

**[Internal Error 14] *INF E*****Probable Cause**

Internal microprocessor detected error.

**Remedy**

- Verify that the error code can be cleared.
- Contact your local Schneider Electric representative.

**Clearing the Error Code**

This detected error requires a power reset.

### [Internal Error 15] *INF F*



#### Probable Cause

Serial memory flash format error.



#### Remedy

Contact your local Schneider Electric representative.



#### Clearing the Error Code

This detected error requires a power reset.

### [Internal Error 16] *INF G*



#### Probable Cause

Communication interruption or internal error of output relays option module



#### Remedy

- Verify that the option module is correctly connected to the slot
- Replace the option module.
- Contact your local Schneider Electric representative.



#### Clearing the Error Code

This detected error requires a power reset.

**[Internal Error 17] INFH****Probable Cause**

Communication interruption with the Extension module of digital & analog I/O or internal error of the Extension module of digital & analog I/O.

**Remedy**

- Verify that the option module is correctly connected to the slot
- Replace the option module.
- Contact your local Schneider Electric representative.

**Clearing the Error Code**

This detected error requires a power reset.

**[Internal Error 20] INFK****Probable Cause**

Option module interface board error.

**Remedy**

Contact your local Schneider Electric representative.

**Clearing the Error Code**

This detected error requires a power reset.

### [Internal Error 21] *INF L*



#### Probable Cause

Internal Real Time Clock error. It could be a communication error between the keypad and the drive or a clock oscillator start error.



#### Remedy

Contact your local Schneider Electric representative.



#### Clearing the Error Code

This detected error requires a power reset.

### [Internal Error 25] *INF P*



#### Probable Cause

Incompatibility between Control Board hardware version and firmware version.



#### Remedy

- Update the firmware package.
- Contact your local Schneider Electric representative.



#### Clearing the Error Code

This detected error requires a power reset.

**[Internal Error 27] INF r****Probable Cause**

Diagnostics in CPLD have detected an error.

**Remedy**

Contact your local Schneider Electric representative.

**Clearing the Error Code**

This detected error requires a power reset.

**[Internal Error 30] INF u****Probable Cause**

An error on the rectifier brick has been detected.

**Remedy**

Contact your local Schneider Electric representative.

**Clearing the Error Code**

This detected error requires a power reset.

## [Input Contactor] L C F



### Probable Cause

The drive is not switched on even though **[Mains V. time out] L C E** timeout has elapsed.



### Remedy

- Verify the input contactor and its wiring.
- Verify the **[Mains V. time out] L C E** timeout.
- Verify the supply mains/contactor/drive wiring.



### Clearing the Error Code

This detected error can be cleared with the **[Auto Fault Reset] R E r** or manually with the **[Fault Reset Assign] r 5 F** parameter after the cause has been removed.

## [AI1 4-20mA loss] L F F I



### Probable Cause

Loss of the 4-20 mA on analog input AI1.

This error is triggered when the measured current is below 2 mA.



### Remedy

- Verify the connection on the analog inputs.
- Verify the setting of **[AI1 4-20mA loss] L F L I** parameter.



### Clearing the Error Code

This detected error can be cleared with the **[Auto Fault Reset] R E r** or manually with the **[Fault Reset Assign] r 5 F** parameter after the cause has been removed.

**[AI2 4-20mA loss] L F F 2****Probable Cause**

Loss of the 4-20 mA on analog input AI2.  
This error is triggered when the measured current is below 2 mA.

**Remedy**

- Verify the connection on the analog inputs.
- Verify the setting of **[AI2 4-20mA loss] L F L 2** parameter.

**Clearing the Error Code**

This detected error can be cleared with the **[Auto Fault Reset] R L r** or manually with the **[Fault Reset Assign] r S F** parameter after the cause has been removed.

**[AI3 4-20mA loss] L F F 3****Probable Cause**

Loss of the 4-20 mA on analog input AI3.  
This error is triggered when the measured current is below 2 mA.

**Remedy**

- Verify the connection on the analog inputs.
- Verify the setting of **[AI3 4-20mA loss] L F L 3** parameter.

**Clearing the Error Code**

This detected error can be cleared with the **[Auto Fault Reset] R L r** or manually with the **[Fault Reset Assign] r S F** parameter after the cause has been removed.

### [AI4 4-20mA loss] L F F 4



#### Probable Cause

Loss of the 4-20 mA on analog input AI4.

This error is triggered when the measured current is below 2mA.



#### Remedy

- Verify the connection on the analog inputs.
- Verify the setting of [AI4 4-20mA loss] L F L 4 parameter.



#### Clearing the Error Code

This detected error can be cleared with the [Auto Fault Reset] *R E r* or manually with the [Fault Reset Assign] *r 5 F* parameter after the cause has been removed.

### [AI5 4-20mA loss] L F F 5



#### Probable Cause

Loss of the 4-20 mA on analog input AI5.

This error is triggered when the measured current is below 2 mA.



#### Remedy

- Verify the connection on the analog inputs.
- Verify the setting of [AI5 4-20mA loss] L F L 5 parameter.



#### Clearing the Error Code

This detected error can be cleared with the [Auto Fault Reset] *R E r* or manually with the [Fault Reset Assign] *r 5 F* parameter after the cause has been removed.



**[Lead Pump Error]  $\Pi P L F$** **Probable Cause**

The selected lead pump is not available while in run.

**Remedy**

Verify the state of the corresponding drive digital input for the pump availability information (for example **[Pump 1 Ready Assign]  $\Pi P 1$**  for the pump 1).

**Clearing the Error Code**

This detected error can be cleared with the **[Auto Fault Reset]  $\Pi L r$**  or manually with the **[Fault Reset Assign]  $r 5 F$**  parameter after the cause has been removed.

**[DC Bus Overvoltage]  $\sigma b F$** **Probable Cause**

- Deceleration time too short or driving load too high.
- Supply mains voltage too high.

**Remedy**

- Increase the deceleration time.
- Configure the **[Dec ramp adapt.]  $b r H$**  function if it is compatible with the application.
- Verify the supply mains voltage.

**Clearing the Error Code**

This detected error can be cleared with the **[Auto Fault Reset]  $\Pi L r$**  or manually with the **[Fault Reset Assign]  $r 5 F$**  parameter after the cause has been removed.

## [Overcurrent] □ CF



### Probable Cause

- Parameters in the **[Motor data] P0A** - menu are not correct.
- Inertia or load too high.
- Mechanical locking.



### Remedy

- Verify the motor parameters.
- Verify the size of the motor/drive/load.
- Verify the state of the mechanism.
- Decrease **[Current limitation] CL1**.
- Increase the switching frequency.



### Clearing the Error Code

This detected error requires a power reset.

## [Drive Overheating] □ HF



### Probable Cause

Drive temperature too high.



### Remedy

Verify the motor load, the drive ventilation, and the ambient temperature. Wait for the drive to cool down before restarting.



### Clearing the Error Code

This detected error can be cleared with the **[Auto Fault Reset] REr** or manually with the **[Fault Reset Assign] r5F** parameter after the cause has been removed.

**[Process Overload] p L C****Probable Cause**

Process overload.

**Remedy**

- Verify and remove the cause of the overload.
- Verify the parameters of the **[Process overload] p L d** - function.

**Clearing the Error Code**

This detected error can be cleared with the **[Auto Fault Reset] R E r** or manually with the **[Fault Reset Assign] r S F** parameter after the cause has been removed.

**[Motor Overload] p L F****Probable Cause**

Triggered by excessive motor current.

**Remedy**

- Verify the setting of the motor thermal monitoring
- Verify the motor load. Wait for the motor to cool down before restarting
- Verify the setting of the following parameters:
  - **[Motor Th Current] i L H**
  - **[Motor Thermal Mode] L H L**
  - **[Motor Therm Thd] L L d**
  - **[MotorTemp ErrorResp] p L L**

**Clearing the Error Code**

This detected error can be cleared with the **[Auto Fault Reset] R E r** or manually with the **[Fault Reset Assign] r S F** parameter after the cause has been removed.

**[Single Output Phase Loss]  $\alpha P F 1$** **Probable Cause**

Loss of one phase at drive output.

**Remedy**

Verify the wiring from the drive to the motor.

**Clearing the Error Code**

This detected error can be cleared with the **[Auto Fault Reset]  $A E r$**  or manually with the **[Fault Reset Assign]  $r 5 F$**  parameter after the cause has been removed.

**[Output Phase Loss]  $\alpha P F 2$** **Probable Cause**

- Motor not connected or motor power too low.
- Output contactor opened.
- Instantaneous instability in the motor current.

**Remedy**

- Verify the wiring from the drive to the motor.
- If an output contactor is being used, set **[OutPhaseLoss Assign]  $\alpha P L$**  to **[No Error Triggered]  $\alpha A C$** .
- If the drive is connected to a low-power motor or not connected to a motor: In factory settings mode, motor phase loss detection is active **[Output Phase Loss]  $\alpha P L = [OPF Error Triggered] 4 E 5$** . Deactivate motor phase loss detection **[Output Phase Loss]  $\alpha P L = [Function Inactive] n \alpha$** .
- Verify and optimize the following parameters: **[IR compensation]  $u F r$** , **[Nom Motor Voltage]  $u n 5$**  and **[Rated mot. current]  $n C r$**  and perform **[Autotuning]  $t u n$** .

**Clearing the Error Code**

This detected error can be cleared with the **[Auto Fault Reset]  $A E r$**  or manually with the **[Fault Reset Assign]  $r 5 F$**  parameter after the cause has been removed.

## [Supply Mains Overvoltage] $\square$ 5 F



### Probable Cause

- Supply mains voltage too high.
- Disturbed supply mains.



### Remedy

Verify the supply mains voltage.



### Clearing the Error Code

This detected error can be cleared with the **[Auto Fault Reset]  $\#$  L r** or manually with the **[Fault Reset Assign] r 5 F** parameter after the cause has been removed.

## [PID Feedback Error] P F $\Pi$ F



### Probable Cause

The PID feedback error was out of the allowed range around the set point during the time window.



### Remedy

- Check for mechanical breakdown of pipes.
- Check for water leakage.
- Check for open discharge valve.
- Check for fire hydrant opened.
- Verify the settings of the monitoring function.



### Clearing the Error Code

This detected error can be cleared with the **[Auto Fault Reset]  $\#$  L r** or manually with the **[Fault Reset Assign] r 5 F** parameter after the cause has been removed.

### [Program Loading Error] *P G L F*



#### Probable Cause

Verify that the error code can be cleared.



#### Remedy

Contact your local Schneider Electric representative.



#### Clearing the Error Code

This detected error is cleared as soon as its cause has been removed.

### [Program Running Error] *P G r F*



#### Probable Cause

Verify that the error code can be cleared.



#### Remedy

Contact your local Schneider Electric representative.



#### Clearing the Error Code

This detected error requires a power reset.

**[Input phase loss] PHF****Probable Cause**

- Drive incorrectly supplied or a tripped fused.
- One phase is unavailable.
- 3-phase Drive used on a single-phase supply mains.
- Unbalanced load.

**Remedy**

- Verify the power connection and the fuses.
- Use a 3-phase supply mains.
- Disable the detected error by **[Input phase loss] , PL = [No] n o** if single phase supply mains or DC bus supply is used.

**Clearing the Error Code**

This detected error is cleared as soon as its cause has been removed.

**[Motor short circuit] SCFI****Probable Cause**

Short-circuit or grounding at the drive output.

**Remedy**

- Verify the cables connecting the drive to the motor, and the motor insulation.
- Adjust the switching frequency.
- Connect chokes in series with the motor.

**Clearing the Error Code**

This detected error requires a power reset.

**[Ground Short Circuit] 5 L F 3****Probable Cause**

Significant ground leakage current at the drive output if several motors are connected in parallel.

**Remedy**

- Verify the cables connecting the drive to the motor, and the motor insulation.
- Adjust the switching frequency.
- Connect chokes in series with the motor.
- If you have long cables, verify the setting of **[Ground Fault Activation] L r F L**.

**Clearing the Error Code**

This detected error requires a power reset.

**[IGBT Short Circuit] 5 L F 4****Probable Cause**

Power component detected error.

At product power-on, the IGBTs are tested for short circuit. Thereby an error (short circuit or interruption) has been detected on at least one IGBT. The time to check each transistor is between 1 and 10  $\mu$ s.

**Remedy**

Verify the setting of **[Output Short Circuit Test] 5 L r L** parameter.

Contact your local Schneider Electric representative.

**Clearing the Error Code**

This detected error can be cleared with the **[Auto Fault Reset] A L r** or manually with the **[Fault Reset Assign] r 5 F** parameter after the cause has been removed.



**[Motor Short Circuit] 5 L F 5****Probable Cause**

Short-circuit at drive output.

**Remedy**

- Verify the cables connecting the drive to the motor, and the motor's insulation.
- Contact your local Schneider Electric representative.

**Clearing the Error Code**

This detected error can be cleared with the **[Auto Fault Reset] # L r** or manually with the **[Fault Reset Assign] r 5 F** parameter after the cause has been removed.

**[Modbus Com Interruption] 5 L F 1****Probable Cause**

Communication interruption on the Modbus port.

**Remedy**

- Verify the communication bus.
- Verify the timeout.
- Refer to the Modbus user manual.

**Clearing the Error Code**

This detected error can be cleared with the **[Auto Fault Reset] # L r** or manually with the **[Fault Reset Assign] r 5 F** parameter after the cause has been removed.

**[HMI Com Interruption] 5 L F 3****Probable Cause**

Communication interruption with the Graphic display terminal.

This error is triggered when the command or reference value are given using the Graphic Display Terminal and if the communication is interrupted during more than 2 seconds.

**Remedy**

- Verify the Graphic display terminal connection.
- Verify the timeout.

**Clearing the Error Code**

This detected error can be cleared with the **[Auto Fault Reset] R E r** or manually with the **[Fault Reset Assign] r 5 F** parameter after the cause has been removed.

**[Motor Overspeed] 5 a F****Probable Cause**

- Instability or driving load too high.
- If a downstream contactor is used, the contacts between the motor and the drive have not been closed before applying a Run command.
- The overspeed threshold (corresponding to 110 % of **[Max frequency] L F r**) has been reached.

**Remedy**

- Verify the motor parameter settings.
- Verify the size of the motor/drive/load.
- Verify and close the contacts between the motor and the drive before applying a Run command.
- Verify the consistency between **[Max frequency] L F r** and **[High Speed] H 5 P**. It is recommended to have at least **[Max frequency] L F r ≥ 110% \* [High Speed] H 5 P**.

**Clearing the Error Code**

This detected error can be cleared manually with the **[Fault Reset Assign] r 5 F** parameter after the cause has been removed.

**[Motor Stall Error] 5 E F****Probable Cause**

The stall monitoring function has detected an error.

The **[Motor Stall Error] 5 E F** is triggered on the following conditions:

- The output frequency is smaller than the stalling frequency **[Stall Frequency] 5 E P 3**
- The output current is higher than the stalling current **[Stall Current] 5 E P 2**
- For a duration longer than the stalling time **S[all Max Time] 5 E P 1**.

**Remedy**

- Search for a mechanical blocking of the motor.
- Search for a possible cause of motor overload.
- Verify the settings of the monitoring function.

**Clearing the Error Code**

This detected error can be cleared with the **[Auto Fault Reset] A E r** or manually with the **[Fault Reset Assign] r 5 F** parameter after the cause has been removed.

**[AI2 Thermal Sensor Error] E 2 C F****Probable Cause**

The thermal sensor monitoring function has detected a thermal sensor error on analog input AI2:

- Open circuit, or
- Short circuit.

**Remedy**

- Verify the sensor and its wiring.
- Replace the sensor.
- Verify the setting of **[AI2 Type] A , 2 E** parameter.

**Clearing the Error Code**

This detected error can be cleared with the **[Auto Fault Reset] A E r** or manually with the **[Fault Reset Assign] r 5 F** parameter after the cause has been removed.

**[AI3 Thermal Sensor Error] E 3 C F****Probable Cause**

The thermal monitoring function has detected an error of the thermal sensor connected to the analog input AI3:

- Open circuit, or
- Short circuit

**Remedy**

- Verify the sensor and its wiring.
- Replace the sensor.
- Verify the setting of **[AI3 Type] R 1 3 E** parameter.

**Clearing the Error Code**

This detected error can be cleared with the **[Auto Fault Reset] R E r** or manually with the **[Fault Reset Assign] r 5 F** parameter after the cause has been removed.

**[AI4 Thermal Sensor Error] E 4 C F****Probable Cause**

The thermal monitoring function has detected an error of the thermal sensor connected to the analog input AI4:

- Open circuit, or
- Short circuit

**Remedy**

- Verify the sensor and its wiring.
- Replace the sensor.
- Verify the setting of **[AI4 Type] R 1 4 E** parameter

**Clearing the Error Code**

This detected error can be cleared with the **[Auto Fault Reset] R E r** or manually with the **[Fault Reset Assign] r 5 F** parameter after the cause has been removed.

**[AI5 Thermal Sensor Error] E 5 C F****Probable Cause**

The thermal monitoring function has detected an error of the thermal sensor connected to the analog input AI5:

- Open circuit, or
- Short circuit

**Remedy**

- Verify the sensor and its wiring.
- Replace the sensor.
- Verify the setting of **[AI5 Type] H 1 5 E** parameter.

**Clearing the Error Code**

This detected error can be cleared with the **[Auto Fault Reset] H E r** or manually with the **[Fault Reset Assign] r 5 F** parameter after the cause has been removed.

**[AI2 Th Level Error] E H 2 F****Probable Cause**

The thermal sensor monitoring function has detected a high temperature error on analog input AI2.

**Remedy**

- Search for a possible cause of overheating.
- Verify the settings of the monitoring function.

**Clearing the Error Code**

This detected error can be cleared with the **[Auto Fault Reset] H E r** or manually with the **[Fault Reset Assign] r 5 F** parameter after the cause has been removed.

### [AI3 Th Level Error] *E H 3 F*



#### Probable Cause

The thermal sensor monitoring function has detected a high temperature on analog input AI3.



#### Remedy

- Search for a possible cause of overheating.
- Verify the settings of the monitoring function.



#### Clearing the Error Code

This detected error can be cleared with the **[Auto Fault Reset] *R E r*** or manually with the **[Fault Reset Assign] *r 5 F*** parameter after the cause has been removed.

### [AI4 Th Level Error] *E H 4 F*



#### Probable Cause

The thermal sensor monitoring function has detected a high temperature on analog input AI4.



#### Remedy

- Search for a possible cause of overheating.
- Verify the settings of the monitoring function.



#### Clearing the Error Code

This detected error can be cleared with the **[Auto Fault Reset] *R E r*** or manually with the **[Fault Reset Assign] *r 5 F*** parameter after the cause has been removed.

**[AI5 Th Level Error] E H 5 F****Probable Cause**

The thermal sensor monitoring function has detected a high temperature on analog input AI5.

**Remedy**

- Search for a possible cause of overheating.
- Verify the settings of the monitoring function.

**Clearing the Error Code**

This detected error can be cleared with the **[Auto Fault Reset] P L r** or manually with the **[Fault Reset Assign] r 5 F** parameter after the cause has been removed.

**[IGBT Overheating] E J F****Probable Cause**

Drive power stage overheating.

**Remedy**

- Verify the size of the load/motor/drive according to environment conditions.
- Reduce the switching frequency.

**Clearing the Error Code**

This detected error can be cleared with the **[Auto Fault Reset] P L r** or manually with the **[Fault Reset Assign] r 5 F** parameter after the cause has been removed.

**[Autotuning Error]  $E n F$** **Probable Cause**

- Special motor or motor whose power is not suitable for the drive.
- Motor not connected to the drive.
- Motor not stopped.

**Remedy**

- Verify that the motor/drive are compatible.
- Verify that the motor is connected to the drive during autotuning.
- If an output contactor is being used, verify that it is closed during autotuning.
- Verify that the motor is present and stopped during autotuning.

**Clearing the Error Code**

This detected error can be cleared manually with the **[Fault Reset Assign]  $r 5 F$**  parameter after the cause has been removed.

**[Process Underload]  $u L F$** **Probable Cause**

Process underload.

**Remedy**

- Verify and remove the cause of the underload.
- Verify the parameters of the **[Process underload]  $u L d$**  - function

**Clearing the Error Code**

This detected error can be cleared with the **[Auto Fault Reset]  $R L r$**  or manually with the **[Fault Reset Assign]  $r 5 F$**  parameter after the cause has been removed.



## [Supply Mains UnderV] $\mu 5 F$



### Probable Cause

- Supply mains too low.
- Transient voltage dips.



### Remedy

Verify the voltage and the parameters of [Undervoltage handling]  $\mu 5 b$ .



### Clearing the Error Code

This detected error is cleared as soon as its cause has been removed.

## Section 11.3

### FAQ

#### FAQ

##### Introduction

If the display does not light up, verify the supply mains to the drive.

The assignment of the fast stop or freewheel functions help to prevent the drive starting if the corresponding digital inputs are not switched on. The drive then displays **[Freewheel] n 5 E** in freewheel stop and **[Fast stop] F 5 E** in fast stop. This is a normal behavior since these functions are active at zero so that the drive is stopped if there is a wire break.

Verify that the run command input is activated in accordance with the selected control mode (**[2/3-wire control] E C C** and **[2-wire type] E C E** parameters).

If the reference channel or command channel is assigned to a fieldbus, when the supply mains is connected, the drive displays **[Freewheel] n 5 E**. It remains in stop mode until the fieldbus gives a command.

##### Drive lock in blocking state

The drive is locked in a blocking state and displays **[Freewheel Stop] n 5 E**, if a Run command such as Run forward, Run reverse, DC injection is still active during:

- A product reset to the factory settings,
- A manual "Fault Reset" using **[Fault Reset Assign] r 5 F**,
- A manual "Fault reset" by applying a product switched off and on again,
- A stop command given by a channel that is not the active channel command (such as Stop key of the display terminal in 2/3 wires control),

It will be necessary to deactivate all active Run commands prior to authorizing a new Run command.

##### Option Module Changed or Removed

When an option module is removed or replaced by another, the drive locks in **[Incorrect configuration] C F F** error mode at power-on. If the option module has been deliberately changed or removed, the detected error can be cleared by pressing the **OK** key twice, which causes the factory settings to be restored for the parameter groups affected by the option module.

##### Control Block Changed

When a control block is replaced by a control block configured on a drive with a different rating, the drive locks in **[Incorrect configuration] C F F** error mode at power-on. If the control block has been deliberately changed, the detected error can be cleared by pressing the **OK** key twice, which **causes all the factory settings to be restored**.



